



Manufacturing, Transportation and Logistics Supplies Catalog



SEE MORE. DO MORE.



Many of the world's manufacturing, warehousing and distribution operations trust Zebra to enable the tracking of assets, work-in-process, parts inventory management, streamline receiving, put-away, delivery, route accounting and picking operations.

Effective January 2015



SEE MORE.
DO MORE.

Table of Contents

Manufacturing, Transportation & Logistics Price List

Manufacturing Operations

Asset Tracking	3
<i>Using barcodes to track physical assets throughout their lifecycle in order to reduce costs, ensure efficiency, and promote better management of assets.</i>	
Product Labeling	5
<i>Identifying products in order to convey some type of information to the public. Zebra includes Brand Protection, Chemical, Computers, Electronics & Telecommunications, Pharmaceutical, UDI, Small Item Marking, and UID to be specific fields where product Labeling will be most beneficial.</i>	
Quality Assurance	14
<i>Going through a series of activities to ensure a product meets all requirements during the manufacturing process..</i>	
Work-in-Process	15
<i>Monitoring each phase in the manufacturing process to ensure consistent quality and output. Employees use online or portable readers to scan barcodes from routing sheets, to track work-in-process costs and manufacturing progress.</i>	
Parts Inventory Management	16
<i>Tracking parts to ensure efficient processes and management once an asset is received and put on the shelf.</i>	

Warehouse Operations and Logistics

Compliance Labeling	17
<i>Ensuring that everyone practices a similar labeling approach that clearly defines the label format, usage, and information to include on the label.</i>	
Inventory Management	18
<i>Tracking and managing material and goods that are available as stock from a company.</i>	
Load Management	19
<i>Automating procedures to make sure a warehouse is running as efficient as possible.</i>	
Order Picking & Staging	20
<i>Collecting items from a warehouse to satisfied an order or need for the item.</i>	
Security	22
<i>Tracking and confirming the distribution of authentic goods, which includes Access and Identification.</i>	
Shipping & Receiving	24
<i>Transporting and tracking goods throughout the supply chain to make sure they reach their final destination.</i>	

<u>RFID Labels</u>	28
---------------------------------	----

<u>Ribbons</u>	30
-----------------------------	----

Note: Price Per M = Price Per Thousand

Stock - ships within one business day, Made to order - ships within 6 business days.
Prices effective January 2015 - All prices subject to change without notice.

Need a custom solution? Call for a quote today: +1 866 230 9495



SEE MORE.
DO MORE.

Catalog Updates

Manufacturing, Transportation & Logistics Price List

New Items

Tabletop Labels

Z-Perform 2000D with Rubber Adhesive (p. 24)

10021199

Z-Perform 2000T with Rubber Adhesive (p. 26)

10021198, 10018349, 10018351

Ribbon

Red Resin (p. 30)

74801, 74802

New Lower Price

Z-Perform 2000D with Rubber Adhesive (p. 24)

10018341

*Stock - ships within one business day, Made to order - ships within 6 business days.
Prices effective January 2015 - All prices subject to change without notice.*

Need a custom solution? Call for a quote today: **+1 866 230 9495**



SEE MORE.
DO MORE.

Asset Tracking

PolyPro 4000T

A Kimdura® polypropylene label with a permanent acrylic adhesive

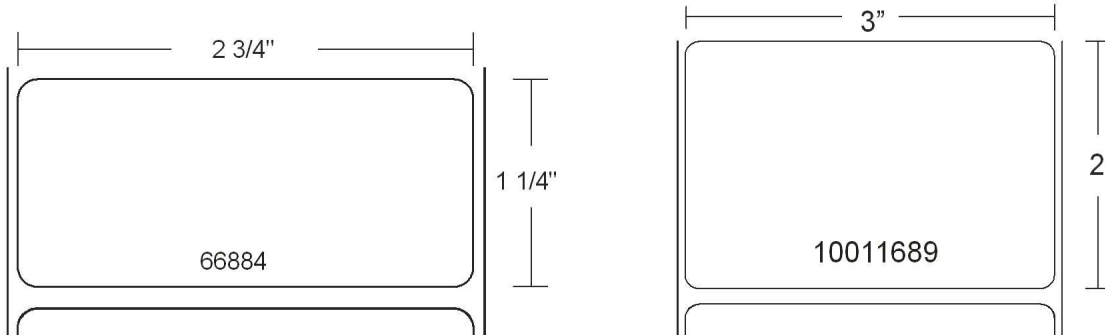

Size (inches)	ID	OD	PartNumber	Quantity Per Roll	Rolls Per Carton	Carton Weight	Stock MTO	Ribbon
2.75" x 1.25"	3"	8"	10014717	3,210	4	28 lbs.	Stock	06100BK08045
3" x 2"	3"	8"	10011689	2,230	4	20 lbs.	Stock	06100BK08045

* Perforation between labels

Z-Ultimate 2000T White

A pearl white, gloss polyester gloss thermal transfer label with a high performance permanent acrylic adhesive. UL/cUL recognized for indoor use when used with compatible Zebra Resin Ribbons.

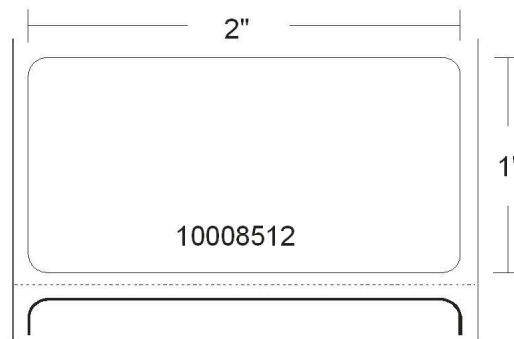

Size (inches)	ID	OD	PartNumber	Quantity Per Roll	Rolls Per Carton	Carton Weight	Stock MTO	Ribbon
2" x 1"	3"	8"	10008512*	5,570	4	12 lbs.	Stock	06200BK06045

* Perforation between labels

Stock - ships within one business day, Made to order - ships within 6 business days.
Prices effective January 2015 - All prices subject to change without notice.

Need a custom solution? Call for a quote today: +1 866 230 9495



SEE MORE.
DO MORE.

Asset Tracking

Z-Ultimate 4000T High Tack White

A gloss polyester gloss thermal transfer label with a high tack permanent acrylic adhesive. UL/cUL recognized for indoor and outdoor use when used with compatible Zebra Resin Ribbons.

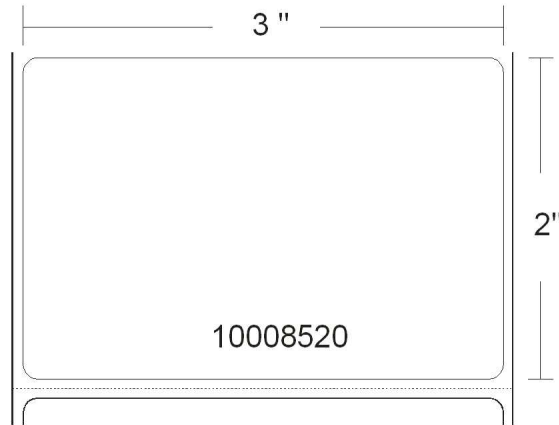

Size (inches)	ID	OD	PartNumber	Quantity Per Roll	Rolls Per Carton	Carton Weight	Stock MTO	Ribbon
3" x 2"	3"	8"	10008520*	2,280	4	20 lbs.	Stock	06200BK08345

* Perforation between labels

Stock - ships within one business day, Made to order - ships within 6 business days.
Prices effective January 2015 - All prices subject to change without notice.

Need a custom solution? Call for a quote today: +1 866 230 9495



SEE MORE.
DO MORE.

Product Labeling

Chemical - GHS - Not Transported via an International Waterway

PolyPro 4000T

A Kimdura® polypropylene label with a permanent acrylic adhesive

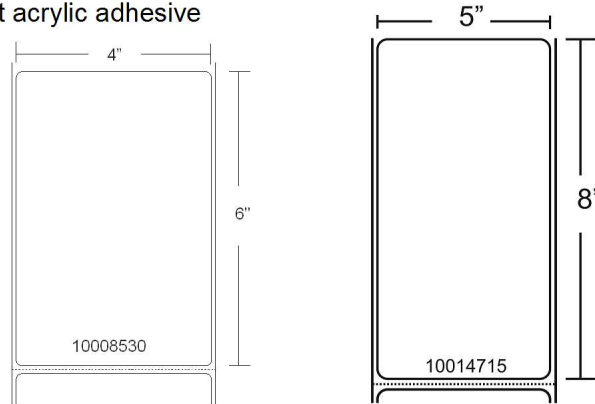

Size (inches)	ID	OD	PartNumber	Quantity Per Roll	Rolls Per Carton	Carton Weight	Stock MTO	Ribbon
4" x 6"	3"	8"	10008530*	720	4	32 lbs.	Stock	06100BK11045
5" x 8"	3"	8"	10014715*	560	4	24 lbs.	Stock	06100BK13145

* Perforation between labels

Z-Ultimate 4000T White

A white, polyester gloss thermal transfer label with a high performance permanent acrylic adhesive. UL/cUL recognized for indoor and outdoor use when used with compatible Zebra Resin Ribbons.

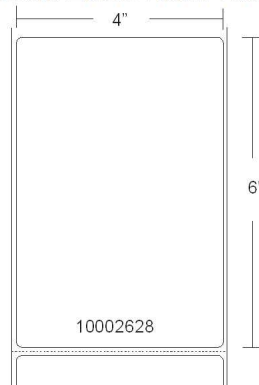

Size (inches)	ID	OD	PartNumber	Quantity Per Roll	Rolls Per Carton	Carton Weight	Stock MTO	Ribbon
4" x 6"	3"	8"	10002628*	960	4	32 lbs.	Stock	05100BK11045

* Perforation between labels

Note: The above GHS solutions are intended for chemicals NOT shipping via an international waterway. Zebra offers several custom solutions for chemicals shipping via an international waterway that are BS 5609 Section 2 and 3 certified. Please contact your Zebra sales representative for more information. Please see ribbon page (last page in catalog) for specification and pricing information on Red Resin ribbon.



SEE MORE.
DO MORE.

Product Labeling

Chemical - GHS - Not Transported via an International Waterway

Z-Ultimate 4000T High Tack White

A white thermal transfer gloss polyester label with a high tack permanent acrylic adhesive. UL/cUL recognized for indoor and outdoor use when used with compatible Zebra Resin Ribbons.

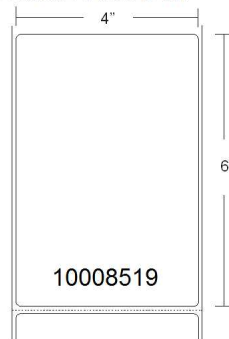

Size (inches)	ID	OD	PartNumber	Quantity Per Roll	Rolls Per Carton	Carton Weight	Stock MTO	Ribbon
4" x 6"	3"	8"	10008519*	790	4	32 lbs.	Stock	06200BK11045

* Perforation between labels

Note: The above GHS solutions are intended for chemicals NOT shipping via an international waterway. Zebra offers several custom solutions for chemicals shipping via an international waterway that are BS 5609 Section 2 and 3 certified. Please contact your Zebra sales representative for more information. Please see ribbon page (last page in catalog) for specification and pricing information on Red Resin ribbon.



SEE MORE.
DO MORE.

Product Labeling

Computers, Electronics & Telecommunication

Z-Ultimate 2000T White

A pearl white, gloss polyester gloss thermal transfer label with a high performance permanent acrylic adhesive. UL/cUL recognized for indoor use when used with compatible Zebra Resin Ribbons.

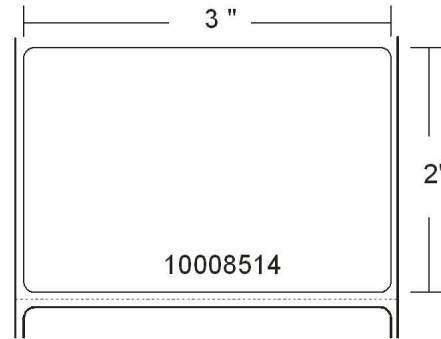
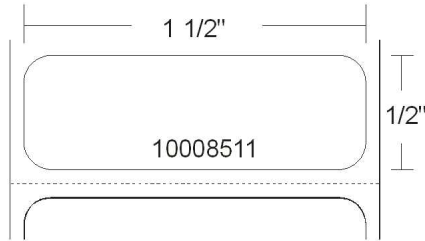

Size (inches)	ID	OD	PartNumber	Quantity Per Roll	Rolls Per Carton	Carton Weight	Stock MTO	Ribbon
1.5" x 0.5"	3"	8"	10008511*	9,220	4	9 lbs.	Stock	06200BK06045
3" x 2"	3"	8"	10008514*	2,950	4	20 lbs.	Stock	06200BK08345

* Perforation between labels

Stock - ships within one business day, Made to order - ships within 6 business days.
Prices effective January 2015 - All prices subject to change without notice.

Need a custom solution? Call for a quote today: +1 866 230 9495



SEE MORE.
DO MORE.

Product Labeling

Computers, Electronics & Telecommunication

8000T Vinyl Clear - Self-Laminating Wire Wrap Label

A thermal transfer, clear vinyl label with a full-width white printable area and a permanent acrylic adhesive that provides excellent durability and chemical resistance. The conformable vinyl material utilizes a self-laminating design that provides additional image durability.

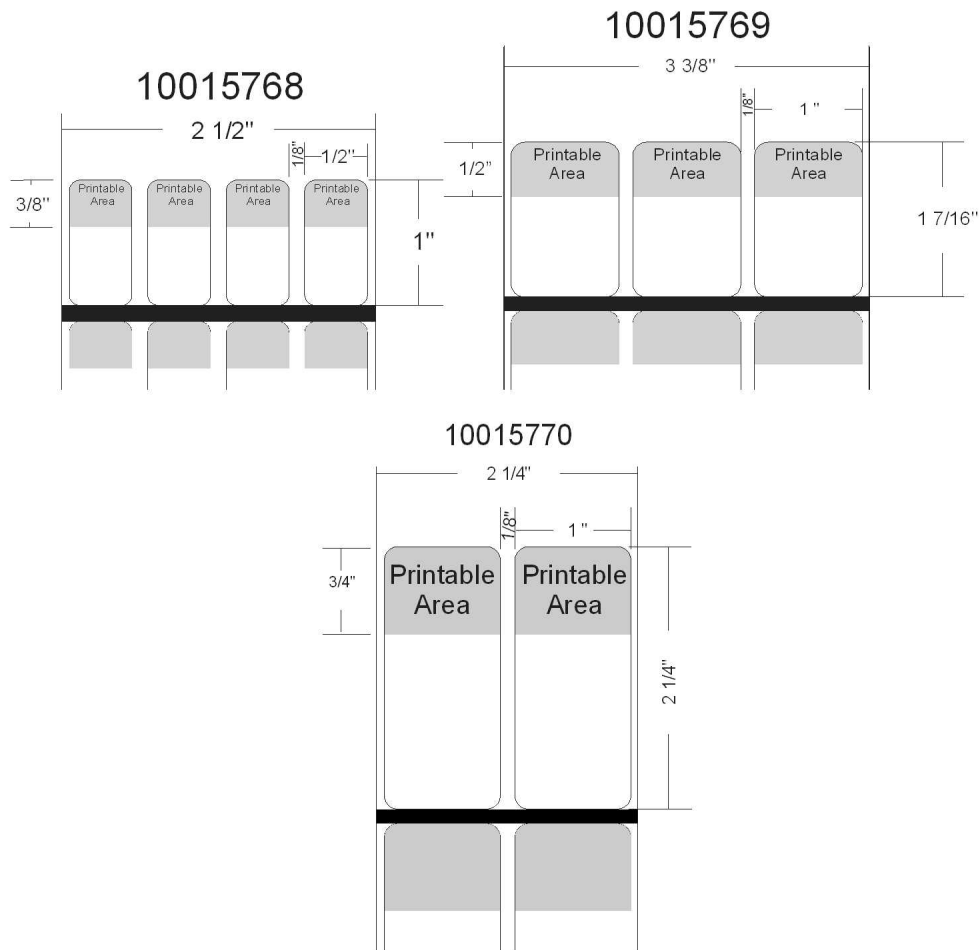

Size (inches)	ID	OD	PartNumber	Quantity Per Roll	Rolls Per Carton	Carton Weight	Labels Across	Stock MTO	Ribbon
0.5" x 1"	3"	8"	10015768 [^]	5,000	1	4 lbs.	4	Stock	05555BK08345
1" x 1.437"	3"	8"	10015769 [^]	7,500	1	4 lbs.	3	Stock	05555BK08945
1" x 2.25"	3"	8"	10015770 [^]	3,000	1	4 lbs.	2	Stock	05555BK06045

* Perforation between labels [^] Labels are equipped with black mark sensing

Stock - ships within one business day, Made to order - ships within 6 business days.
Prices effective January 2015 - All prices subject to change without notice.

Need a custom solution? Call for a quote today: +1 866 230 9495



SEE MORE.
DO MORE.

Product Labeling

Computers, Electronics & Telecommunication

Z-Supreme 2000T White

A thermal transfer gloss polyimide label with a high-temp permanent acrylic adhesive that provides resistance to temperatures up to 500°F. UL recognized for indoor use when used with compatible genuine Zebra resin ribbons.

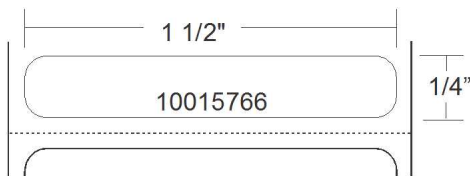
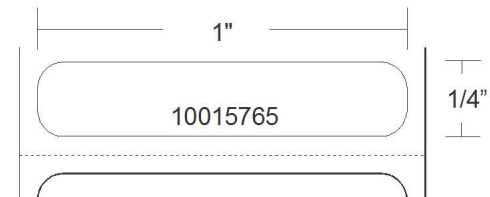
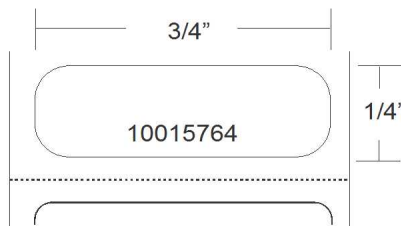
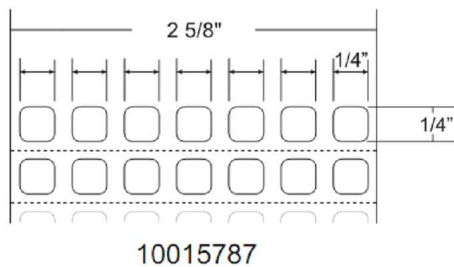

Size (inches)	ID	OD	PartNumber	Quantity Per Roll	Rolls Per Carton	Carton Weight	Labels Across	Stock MTO	Ribbon
0.25" x 0.25"	3"	8"	10015787*	10,003	1	2 lbs.	7	Stock	05100BK08345
0.75" x 0.25"	3"	8"	10015764*	10,000	1	2 lbs.	1	Stock	05100BK04045
1" x 0.25"	3"	8"	10015765*	10,000	1	2 lbs.	1	Stock	05100BK04045
1.5" x 0.25"	3"	8"	10015766*	10,000	1	2 lbs.	1	Stock	05100BK04045

* Perforation between labels

Stock - ships within one business day, Made to order - ships within 6 business days.
Prices effective January 2015 - All prices subject to change without notice.

Need a custom solution? Call for a quote today: +1 866 230 9495



SEE MORE.
DO MORE.

Product Labeling

Pharmaceutical

Z-Select 4000T

A premium white, thermal transfer paper label with a permanent acrylic adhesive that may be used across a wide temperature range.

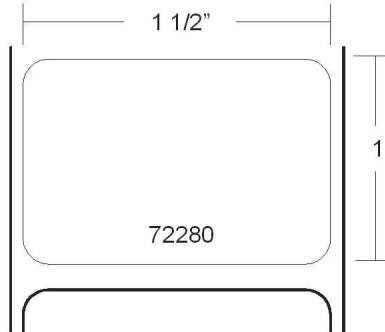

Size (inches)	ID	OD	PartNumber	Quantity Per Roll	Rolls Per Carton	Carton Weight	Stock MTO	Ribbon
1.5" x 1"	3"	8"	72280	5,180	14	30 lbs.	Stock	06000BK06045

Z-Select 4000T All-Temp

A premium white, thermal transfer paper label with a permanent all-temp acrylic adhesive.

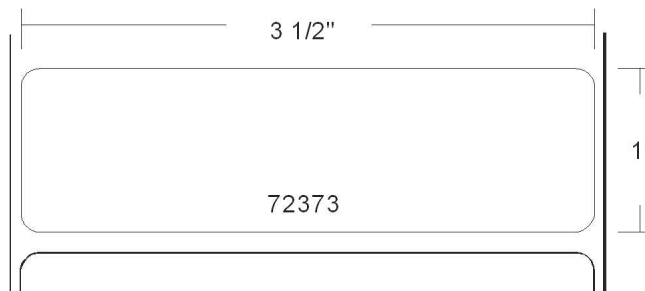

Size (inches)	ID	OD	PartNumber	Quantity Per Roll	Rolls Per Carton	Carton Weight	Stock MTO	Ribbon
3.5" x 1"	3"	8"	72373	5,180	6	30 lbs.	Stock	06000BK10245

Stock - ships within one business day, Made to order - ships within 6 business days.
Prices effective January 2015 - All prices subject to change without notice.

Need a custom solution? Call for a quote today: +1 866 230 9495



SEE MORE.
DO MORE.

Product Labeling

UDI

PolyPro 4000T

A white thermal transfer Kimdura® polypropylene label with a permanent acrylic adhesive. Offers some flexibility for curved surfaces. Excellent resistance to moisture and chemicals.

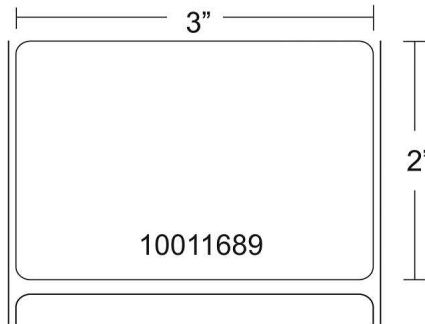

Size (inches)	ID	OD	PartNumber	Quantity Per Roll	Rolls Per Carton	Carton Weight	Stock MTO	Ribbon
3" x 2"	3"	8"	10011689	2,230	4	20 lbs.	Stock	06100BK08045

Z-Ultimate 4000T White

A pearl white gloss polyester thermal transfer label with a high performance permanent acrylic adhesive. Excellent resistance to moisture and chemicals. UL 969 and UL/IEC 60601-1 3rd edition marking and durability rub test certified when paired with 5100 resin ribbon.

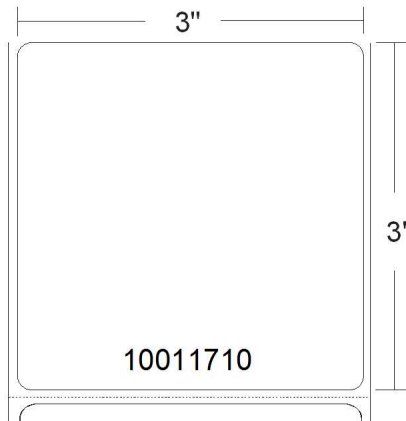

Size (inches)	ID	OD	PartNumber	Quantity Per Roll	Rolls Per Carton	Carton Weight	Stock MTO	Ribbon
3" x 3"	3"	8"	10011710*	1,880	4	20 lbs.	Stock	05100BK08345

* Perforation between labels

Stock - ships within one business day, Made to order - ships within 6 business days.
Prices effective January 2015 - All prices subject to change without notice.

Need a custom solution? Call for a quote today: +1 866 230 9495



SEE MORE.
DO MORE.

Product Labeling

Small Item Marking

Z-Ultimate 2000T White

A pearl white, gloss polyester gloss thermal transfer label with a high performance permanent acrylic adhesive. UL/cUL recognized for indoor use when used with compatible Zebra Resin Ribbons.

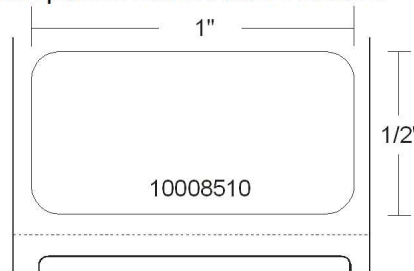

Size (inches)	ID	OD	PartNumber	Quantity Per Roll	Rolls Per Carton	Carton Weight	Stock MTO	Ribbon
1" x 0.5"	3"	8"	10008510*	9,420	4	9 lbs.	Stock	06200BK04045

* Perforation between labels

Z-Supreme 2000T White

A thermal transfer gloss polyimide label with a high-temp permanent acrylic adhesive that provides resistance to temperatures up to 500°F. UL recognized for indoor use when used with compatible genuine Zebra resin ribbons.

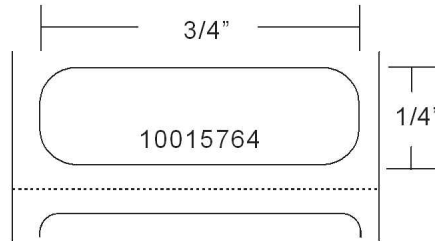

Size (inches)	ID	OD	PartNumber	Quantity Per Roll	Rolls Per Carton	Carton Weight	Stock MTO	Ribbon
0.75" x 0.25"	3"	8"	10015764*	10,000	1	2 lbs.	Stock	05100BK04045

* Perforation between labels

8000D Jewelry (Butterfly Label Without Flaps)

A direct thermal, polypropylene label with a permanent acrylic adhesive.

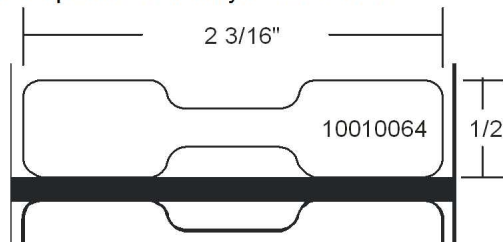

Size (inches)	ID	OD	PartNumber	Quantity Per Roll	Rolls Per Carton	Carton Weight	Stock MTO
2.2" x 0.5"	1"	5"	10010064	3,510	6	12 lbs.	Stock



SEE MORE.
DO MORE.

Product Labeling

UID

PolyPro 4000T

A Kimdura® polypropylene label with a permanent acrylic adhesive

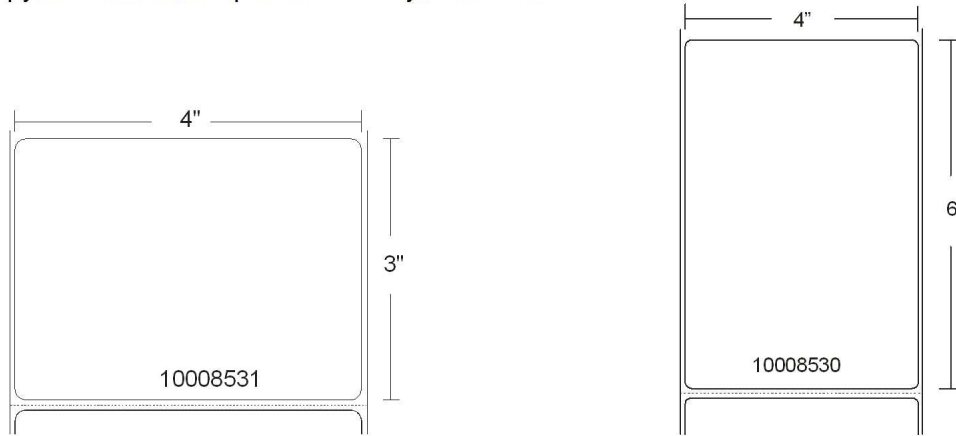

Size (inches)	ID	OD	PartNumber	Quantity Per Roll	Rolls Per Carton	Carton Weight	Stock MTO	Ribbon
4" x 3"	3"	8"	10008531*	1,420	4	32 lbs.	Stock	06200BK11045
4" x 6"	3"	8"	10008530*	720	4	32 lbs.	Stock	06200BK11045

* Perforation between labels

Z-Ultimate 4000T White

A white, polyester gloss thermal transfer label with a high performance permanent acrylic adhesive. UL/cUL recognized for indoor and outdoor use when used with compatible Zebra Resin Ribbons.

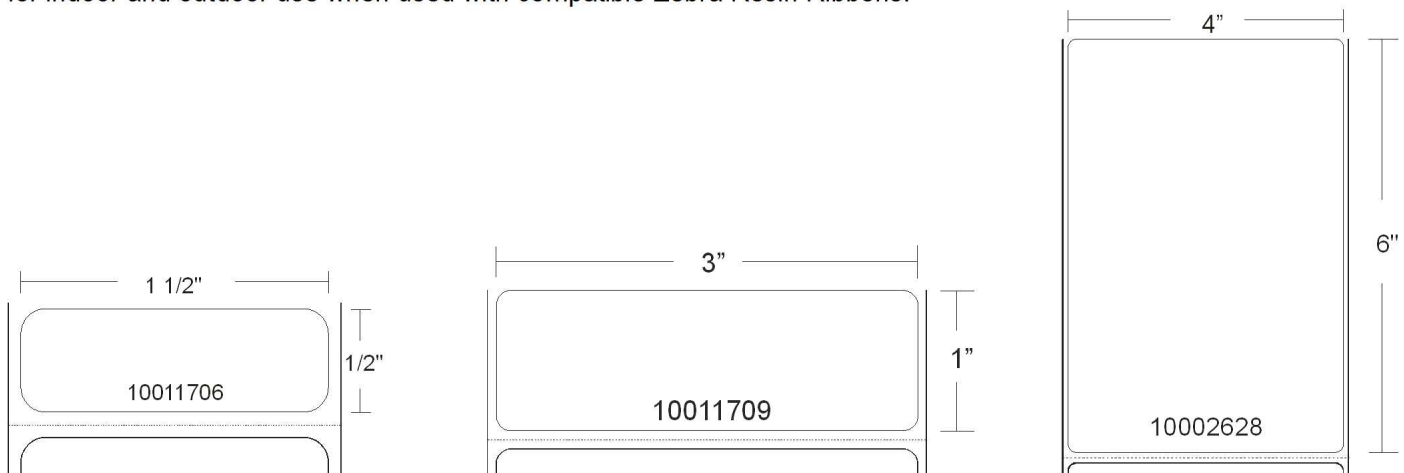

Size (inches)	ID	OD	PartNumber	Quantity Per Roll	Rolls Per Carton	Carton Weight	Stock MTO	Ribbon
1.5" x 0.5"	3"	8"	10011706*	9,420	4	8 lbs.	Stock	05100BK06045
3" x 1"	3"	8"	10011709*	5,240	4	20 lbs.	Stock	05100BK08345
4" x 6"	3"	8"	10002628*	960	4	32 lbs.	Stock	05100BK11045

* Perforation between labels

Stock - ships within one business day, Made to order - ships within 6 business days.
Prices effective January 2015 - All prices subject to change without notice.

Need a custom solution? Call for a quote today: +1 866 230 9495



SEE MORE.
DO MORE.

Quality Assurance

Z-Perform 2000T Floodcoated

A thermal transfer coated paper label with a permanent acrylic adhesive.

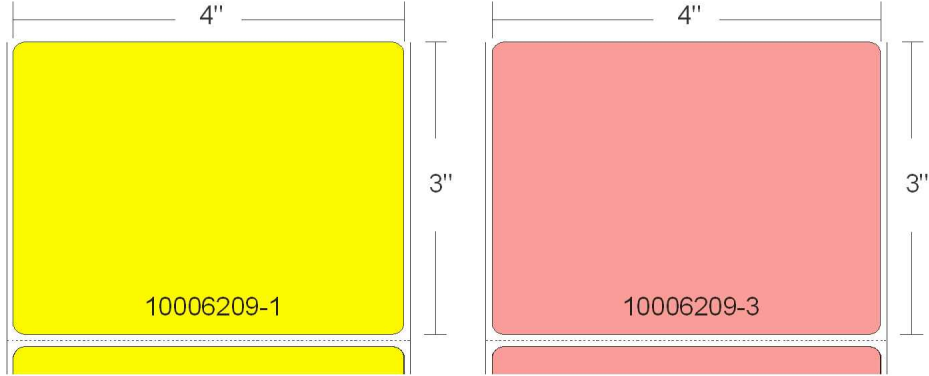

Size (inches)	ID	OD	PartNumber	Color	Quantity Per Roll	Rolls Per Carton	Carton Weight	Stock MTO	Ribbon
4" x 3"	3"	8"	10006209-1*	Yellow	1,840	4	27 lbs.	Stock	06000BK11045
4" x 3"	3"	8"	10006209-3*	Pink	1,840	4	27 lbs.	Stock	06000BK11045

*Stock - ships within one business day, Made to order - ships within 6 business days.
Prices effective January 2015 - All prices subject to change without notice.*

Need a custom solution? Call for a quote today: +1 866 230 9495



SEE MORE.
DO MORE.

Work-In-Process

Work-In-Process

Z-Perform 1000T 7.5 Mil Tag

An uncoated, white, thermal transfer paper tag.

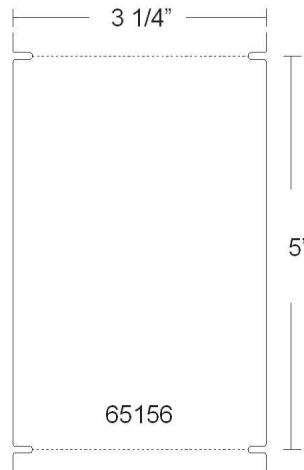

Size (inches)	ID	OD	PartNumber	Quantity Per Roll	Rolls Per Carton	Carton Weight	Stock MTO	Ribbon
3.25" x 5"	3"	8"	65156*	1,030	6	26 lbs.	Stock	06000BK10245

* Perforation between labels

Z-Select 4000T Removable

A premium white, thermal transfer paper label with a removable acrylic adhesive for applications requiring clean removability without damaging the label or surface.

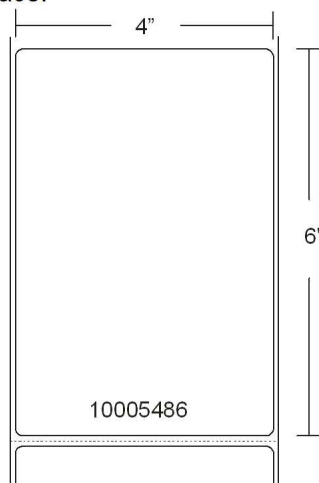

Size (inches)	ID	OD	PartNumber	Quantity Per Roll	Rolls Per Carton	Carton Weight	Stock MTO	Ribbon
4" x 6"	3"	8"	10005486*	1,000	4	27 lbs.	Stock	06000BK11045

* Perforation between labels

Stock - ships within one business day, Made to order - ships within 6 business days.
Prices effective January 2015 - All prices subject to change without notice.

Need a custom solution? Call for a quote today: +1 866 230 9495



SEE MORE.
DO MORE.

Parts Inventory Management

Z-Perform 2000T

A white thermal transfer, coated paper label with a permanent acrylic adhesive.

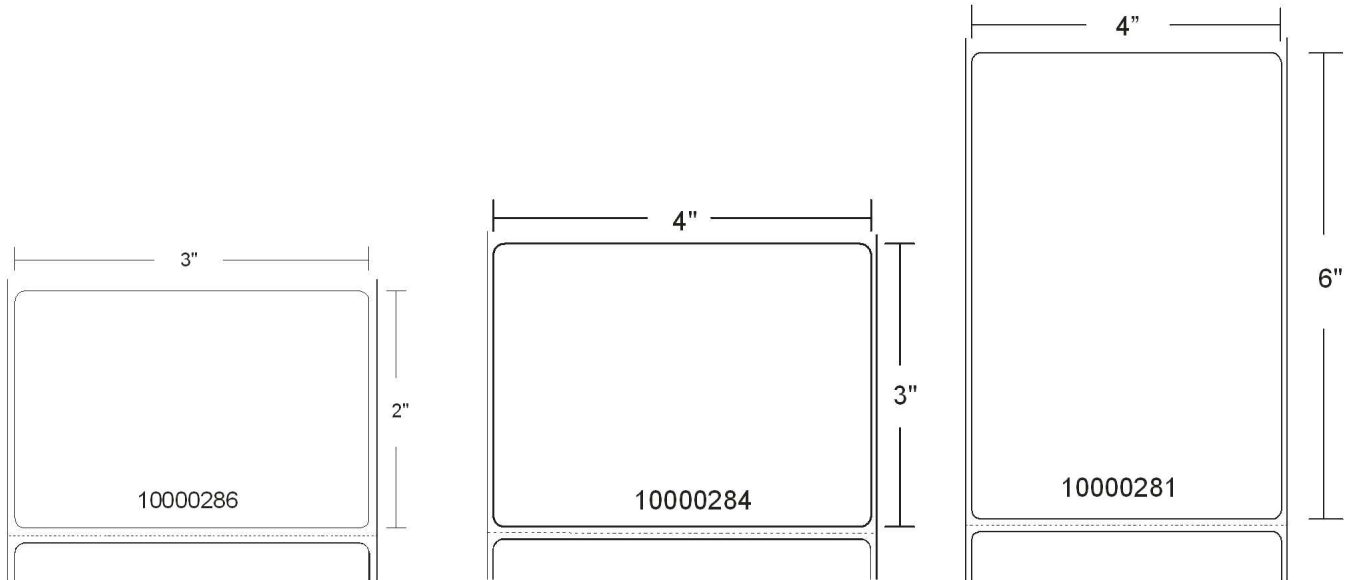

Size (inches)	ID	OD	PartNumber	Quantity Per Roll	Rolls Per Carton	Carton Weight	Stock MTO	Ribbon
3" x 2"	3"	8"	10000286*	2,750	6	27 lbs.	Stock	06000BK08345
4" x 3"	3"	8"	10000284*	2,000	4	27 lbs.	Stock	06000BK11045
4" x 6"	3"	8"	10000281*	1,000	4	27 lbs.	Stock	06000BK11045

* Perforation between labels

Stock - ships within one business day, Made to order - ships within 6 business days.
Prices effective January 2015 - All prices subject to change without notice.

Need a custom solution? Call for a quote today: +1 866 230 9495



SEE MORE.
DO MORE.

Compliance Labeling

Z-Perform 2000T

A thermal transfer coated paper label with a permanent acrylic adhesive.

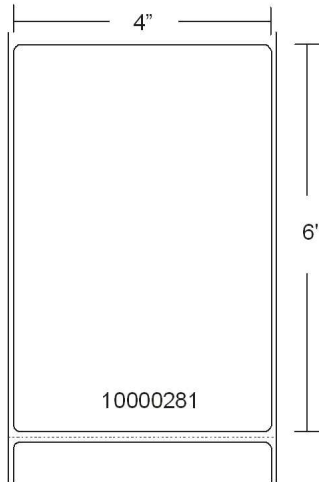

Size (inches)	ID	OD	PartNumber	Quantity Per Roll	Rolls Per Carton	Carton Weight	Stock MTO	Ribbon
4" x 6"	3"	8"	10000281*	1,000	4	27 lbs.	Stock	06000BK11045

* Perforation between labels

Z-Select 4000T

A premium white, thermal transfer paper label with a permanent acrylic adhesive that may be used across a wide temperature range.

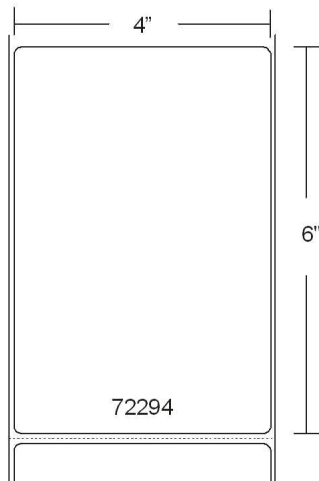

Size (inches)	ID	OD	PartNumber	Quantity Per Roll	Rolls Per Carton	Carton Weight	Stock MTO	Ribbon
4" x 6"	3"	8"	72294*	950	4	26 lbs.	Stock	06000BK11045

* Perforation between labels

Stock - ships within one business day, Made to order - ships within 6 business days.
Prices effective January 2015 - All prices subject to change without notice.

Need a custom solution? Call for a quote today: +1 866 230 9495



SEE MORE.
DO MORE.

Inventory Management

Z-Ultimate 2000T White

A pearl white, gloss polyester gloss thermal transfer label with a high performance permanent acrylic adhesive. UL/cUL recognized for indoor use when used with compatible Zebra Resin Ribbons.

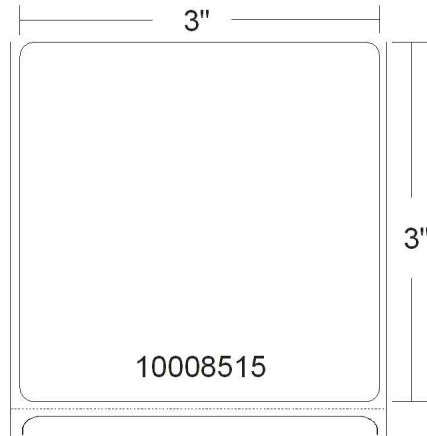

Size (inches)	ID	OD	PartNumber	Quantity Per Roll	Rolls Per Carton	Carton Weight	Stock MTO	Ribbon
3" x 3"	3"	8"	10008515*	1,880	4	20 lbs.	Stock	06200BK08345

* Perforation between labels

Z-Perform 2000T Floodcoated

A thermal transfer coated paper label with a permanent acrylic adhesive.

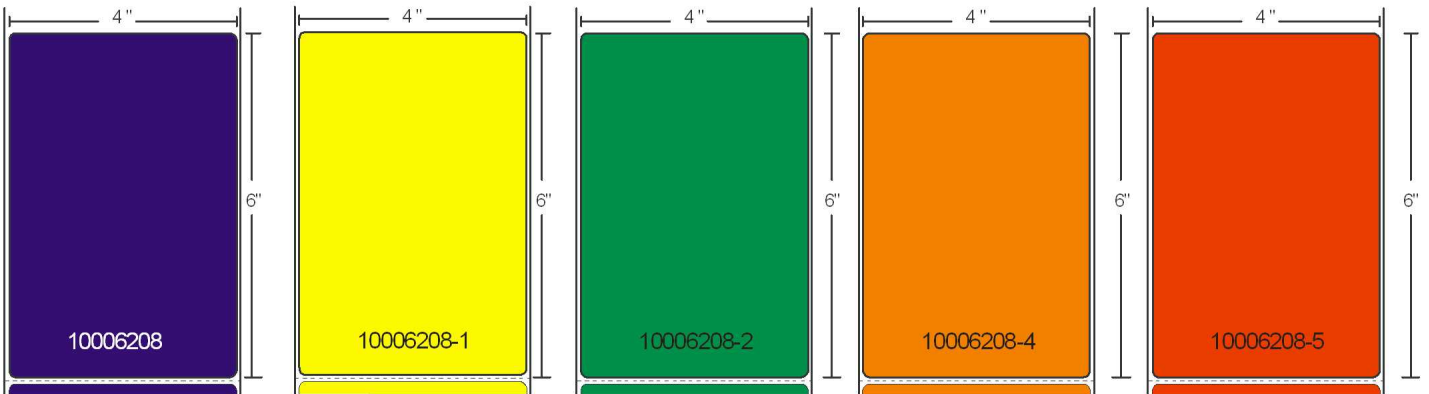

Size (inches)	ID	OD	PartNumber	Color	Quantity Per Roll	Rolls Per Carton	Carton Weight	Stock MTO	Ribbon
4" x 6"	3"	8"	10006208*	Blue	1,000	4	27 lbs.	Stock	06000BK11045
4" x 6"	3"	8"	10006208-1*	Yellow	1,000	4	27 lbs.	Stock	06000BK11045
4" x 6"	3"	8"	10006208-2*	Green	1,000	4	27 lbs.	Stock	06000BK11045
4" x 6"	3"	8"	10006208-4*	Orange	1,000	4	27 lbs.	Stock	06000BK11045
4" x 6"	3"	8"	10006208-5*	Red	1,000	4	27 lbs.	Stock	06000BK11045

Stock - ships within one business day, Made to order - ships within 6 business days.
Prices effective January 2015 - All prices subject to change without notice.

Need a custom solution? Call for a quote today: +1 866 230 9495



SEE MORE.
DO MORE.

Load Management

Z-Perform 2000T

A thermal transfer coated paper label with a permanent acrylic adhesive.

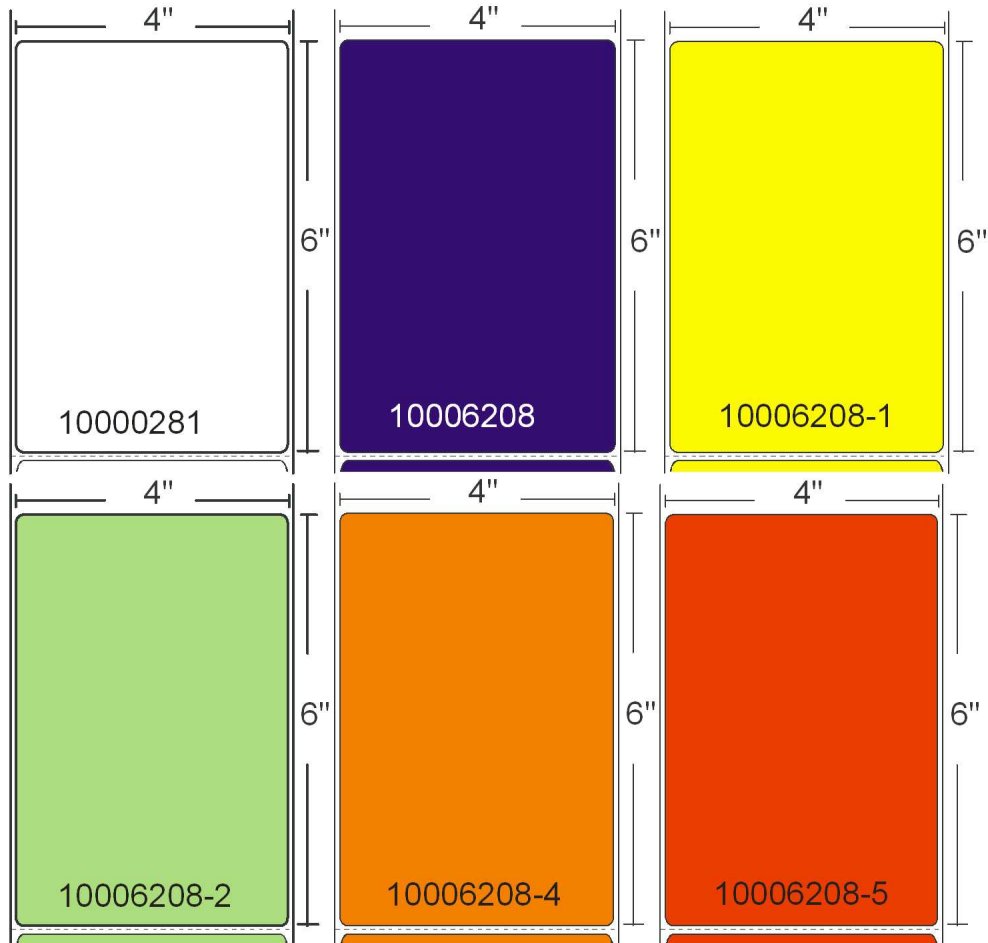

Size (inches)	ID	OD	PartNumber	Color	Quantity Per Roll	Rolls Per Carton	Carton Weight	Stock MTO	Ribbon
4" x 6"	3"	8"	10000281*	White	1,000	4	27 lbs.	Stock	06000BK11045
4" x 6"	3"	8"	10006208*	Blue	1,000	4	27 lbs.	Stock	06000BK11045
4" x 6"	3"	8"	10006208-1*	Yellow	1,000	4	27 lbs.	Stock	06000BK11045
4" x 6"	3"	8"	10006208-2*	Green	1,000	4	27 lbs.	Stock	06000BK11045
4" x 6"	3"	8"	10006208-4*	Orange	1,000	4	27 lbs.	Stock	06000BK11045
4" x 6"	3"	8"	10006208-5*	Red	1,000	4	27 lbs.	Stock	06000BK11045

Stock - ships within one business day, Made to order - ships within 6 business days.
Prices effective January 2015 - All prices subject to change without notice.

Need a custom solution? Call for a quote today: +1 866 230 9495



SEE MORE.
DO MORE.

Order Picking & Staging

Z-Perform 2000D

A direct thermal coated paper label with an all-temp permanent acrylic adhesive.

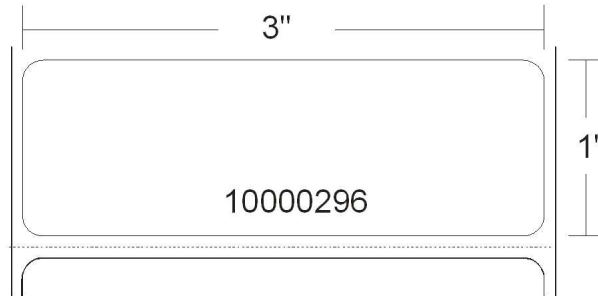

Size (inches)	ID	OD	PartNumber	Quantity Per Roll	Rolls Per Carton	Carton Weight	Stock MTO
3" x 1"	3"	8"	10000296*	5,500	6	26 lbs.	Stock

* Perforation between labels

Z-Perform 2000T

A thermal transfer coated paper label with a permanent acrylic adhesive.

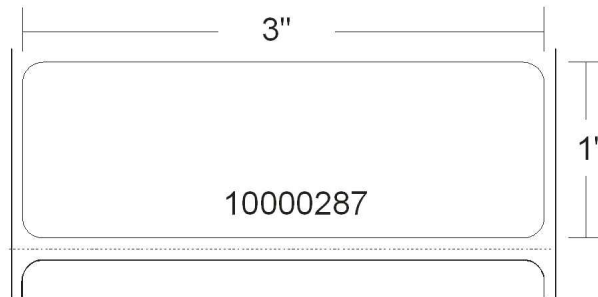

Size (inches)	ID	OD	PartNumber	Quantity Per Roll	Rolls Per Carton	Carton Weight	Stock MTO	Ribbon
3" x 1"	3"	8"	10000287*	5,500	6	27 lbs.	Stock	06000BK08345

* Perforation between labels



SEE MORE.
DO MORE.

Order Picking & Staging

Z-Perform 1000T 7.5 Mil Tag

An uncoated, white, thermal transfer paper tag.

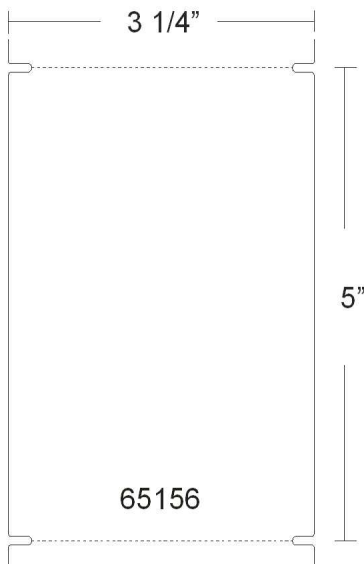

Size (inches)	ID	OD	PartNumber	Quantity Per Roll	Rolls Per Carton	Carton Weight	Stock MTO	Ribbon
3.25" x 5"	3"	8"	65156*	1,030	6	26 lbs.	Stock	06000BK10245

* Perforation between labels

*Stock - ships within one business day, Made to order - ships within 6 business days.
Prices effective January 2015 - All prices subject to change without notice.*

Need a custom solution? Call for a quote today: +1 866 230 9495



SEE MORE.
DO MORE.

Security

Access & Identification

Z-Select 4000D 7.5 Mil Tag

A premium, white paper tag specially coated to provide optimal quality.

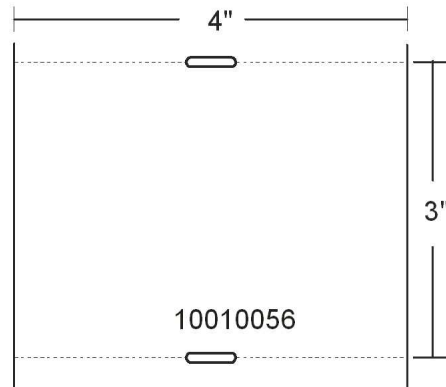

Size (inches)	ID	OD	PartNumber	Quantity Per Roll	Rolls Per Carton	Carton Weight	Stock MTO
4" x 3"	1"	5"	10010056*	730	4	10 lbs.	Stock

* Perforation between labels

Z-Perform 2000T

A thermal transfer coated paper label with a permanent acrylic adhesive.

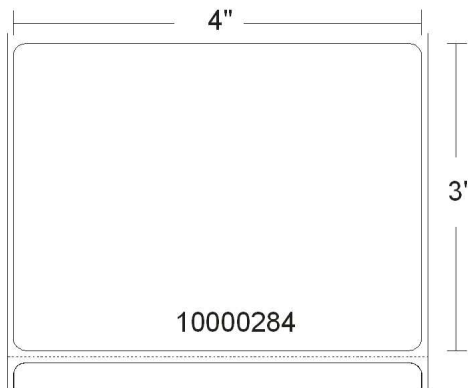

Size (inches)	ID	OD	PartNumber	Quantity Per Roll	Rolls Per Carton	Carton Weight	Stock MTO	Ribbon
4" x 3"	3"	8"	10000284*	2,000	4	27 lbs.	Stock	06000BK11045

* Perforation between labels



SEE MORE.
DO MORE.

Security

Access & Identification

Z-Perform 1000T 7.5 Mil Tag

An uncoated, white, thermal transfer paper tag.

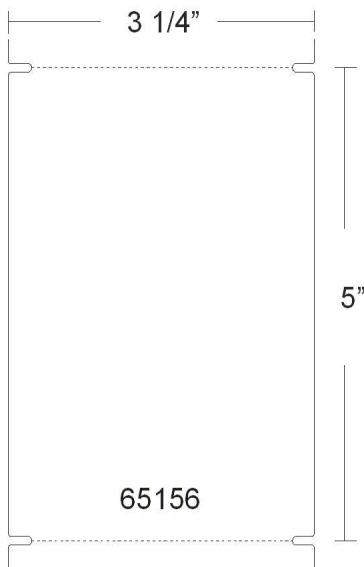

Size (inches)	ID	OD	PartNumber	Quantity Per Roll	Rolls Per Carton	Carton Weight	Stock MTO	Ribbon
3.25" x 5"	3"	8"	65156*	1,030	6	26 lbs.	Stock	06000BK10245

* Perforation between labels

Stock - ships within one business day, Made to order - ships within 6 business days.
Prices effective January 2015 - All prices subject to change without notice.

Need a custom solution? Call for a quote today: +1 866 230 9495



SEE MORE.
DO MORE.

Shipping & Receiving

Z-Perform 2000D

A white direct thermal, coated paper label with an all-temp permanent acrylic adhesive.

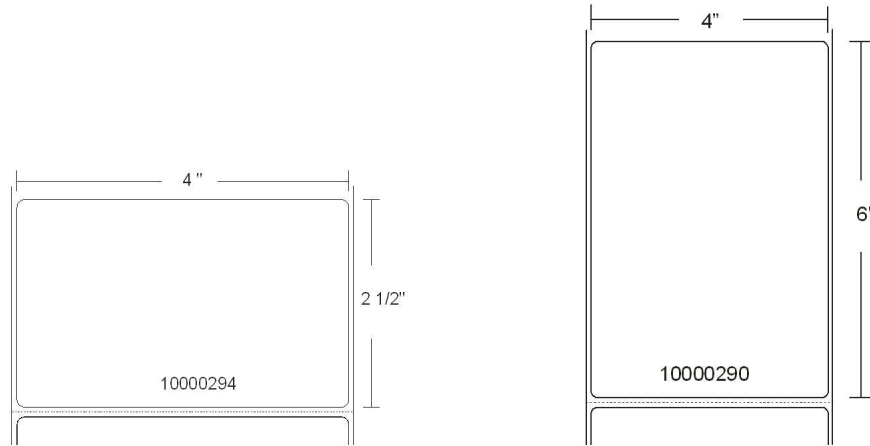

Size (inches)	ID	OD	PartNumber	Quantity Per Roll	Rolls Per Carton	Carton Weight	Stock MTO
4" x 6"	3"	8"	10000290*	1,000	4	26 lbs	Stock
4" x 2.5"	3"	8"	10000294*	2,280	4	25 lbs	Stock

* Perforation between labels

Z-Perform 2000D with Rubber Adhesive

A white direct thermal, coated paper label with a permanent rubber adhesive.

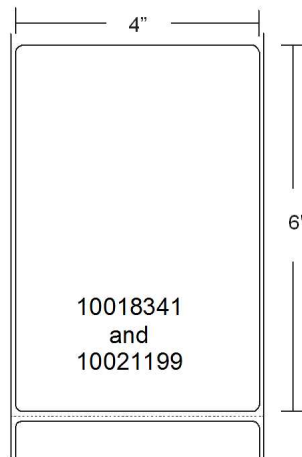

Size (inches)	ID	OD	PartNumber	Quantity Per Roll	Rolls Per Carton	Carton Weight	Stock MTO
4" x 6"	3"	8"	10018341*	1,000	4	26 lbs	Stock
4" x 6"	3"	8"	10021199*^	2,000	2	26 lbs	Stock

* Perforation between labels ^Fanfold

Stock - ships within one business day, Made to order - ships within 6 business days.
Prices effective January 2015 - All prices subject to change without notice.

Need a custom solution? Call for a quote today: +1 866 230 9495



SEE MORE.
DO MORE.

Shipping & Receiving

Z-Perform 1000D

An uncoated, white direct thermal label with a permanent acrylic adhesive.

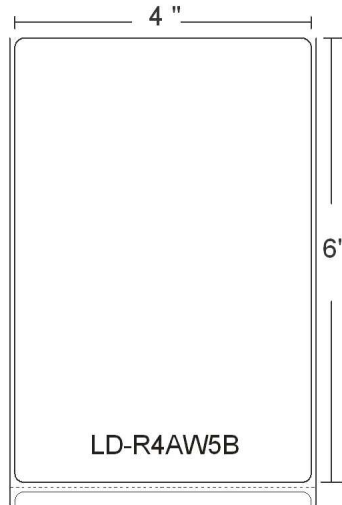

Size (inches)	ID	OD	PartNumber	Quantity Per Roll	Rolls Per Carton	Carton Weight	Stock MTO
4" x 6"	0.75"	2.5"	LD-R4AW5B*	105	36	24 lbs.	Stock

* Perforation between labels

8000D Near-IR (Parcel Shipping Label)

A paper label with a permanent acrylic adhesive that is scannable in both visible and near infrared wavelength.

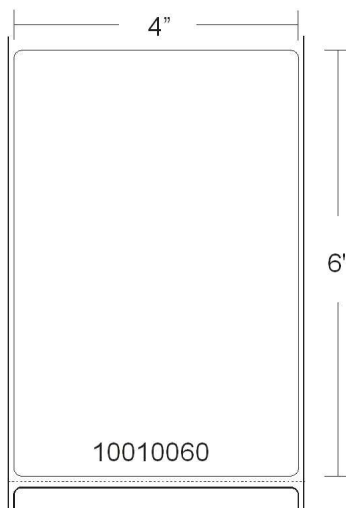

Size (inches)	ID	OD	PartNumber	Quantity Per Roll	Rolls Per Carton	Carton Weight	Stock MTO
4" x 6"	1"	5"	10010060*	410	4	10 lbs.	Stock

* Perforation between labels



SEE MORE.
DO MORE.

Shipping & Receiving

Z-Perform 2000T

A white thermal transfer, coated paper label with a permanent acrylic adhesive.

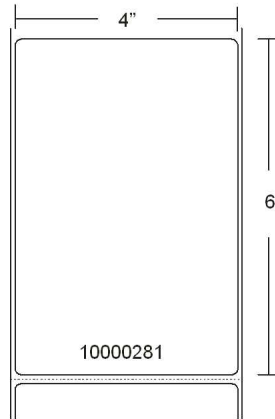

Size (inches)	ID	OD	PartNumber	Quantity Per Roll	Rolls Per Carton	Carton Weight	Stock MTO	Ribbon
4" x 6"	3"	8"	10000281*	1,000	4	27 lbs	Stock	06000BK11045

* Perforation between labels

Z-Perform 2000T with Rubber Adhesive

A white thermal transfer, coated paper label with a rubber adhesive.

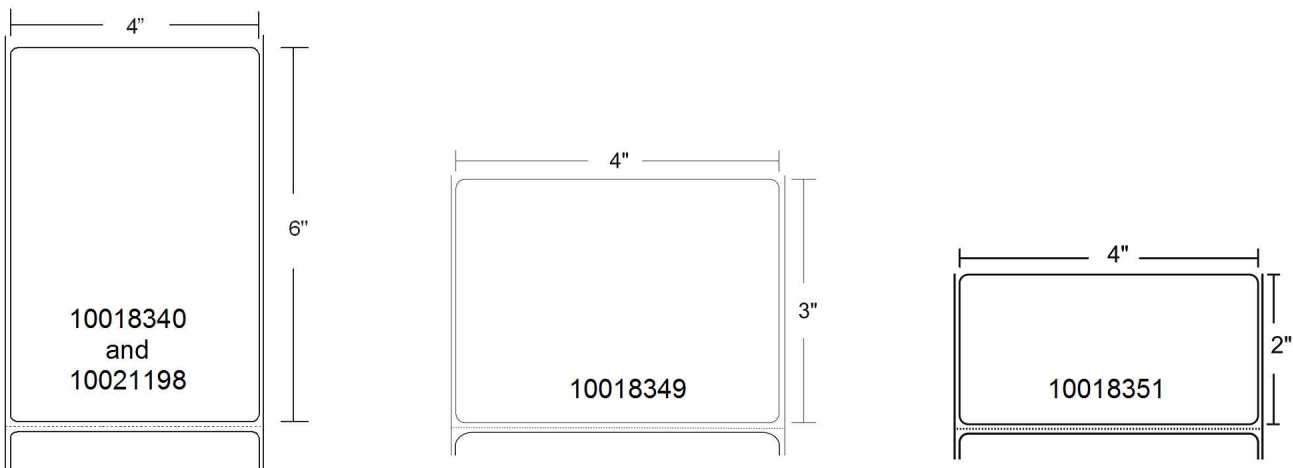

Size (inches)	ID	OD	PartNumber	Quantity Per Roll	Rolls Per Carton	Carton Weight	Stock MTO	Ribbon
4" x 2"	3"	8"	10018351*	3,000	4	26 lbs	Stock	06000BK11045
4" x 3"	3"	8"	10018349*	2,000	4	26 lbs	Stock	06000BK11045
4" x 6"	3"	8"	10018340*	1,000	4	26 lbs	Stock	06000BK11045
4" x 6"	3"	8"	10021198*^	2,000	2	26 lbs	Stock	06000BK11045

* Perforation between labels

^Fanfold



SEE MORE.
DO MORE.

Shipping & Receiving

Z-Slip

A direct thermal, paper tag combined with a clear polypropylene label featuring a permanent acrylic adhesive.

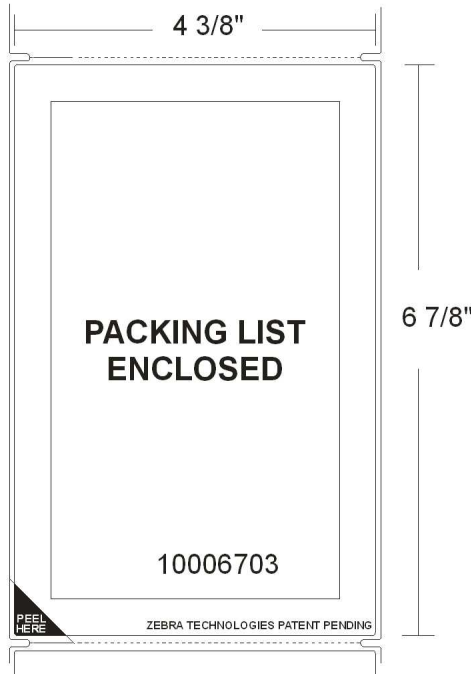

Size (inches)	ID	OD	PartNumber	Quantity Per Roll	Rolls Per Carton	Carton Weight	Stock MTO
4.375" x 6.875"	3"	8"	10006703*	580	4	32 lbs.	Stock
6.625" x 6"	3"	8"	10004425*	660	2	20 lbs	Stock

* Perforation between labels

Stock - ships within one business day, Made to order - ships within 6 business days.
Prices effective January 2015 - All prices subject to change without notice.

Need a custom solution? Call for a quote today: +1 866 230 9495



SEE MORE.
DO MORE.

Shipping & Receiving

Slip And Ship

A direct thermal, paper packing slip and label combination featuring a permanent acrylic adhesive.

FRONT

8 3/8"

PACKING LIST ENCLOSED

ORDER#

BILL TO: SHIP TO:

WHSE	LOC	QTY	ITEM NO.	DESCRIPTION	UNIT PRICE	EXT. PRICE

PACKING LIST ENCLOSED

RETURN LABEL RA#

SHIP TO:

RETURNS:

1. Complete all info on reverse side
2. Use return label
3. Pack carefully and insure contents
4. Obtain a tracking number

PULL DOWN

PACKING LIST ENCLOSED

PULL DOWN

12 13/16"

10007333

BACK

8 3/8"

RETURN POLICY:

Refunds and Exchanges

General Return Instructions

Orders Damaged in Transit

ITEMS TO BE RETURNED:

RETURN CODES: 1. Defective 2. Damaged 3. Wrong merchandise ordered 4. Do not like merchandise 5. Poor quality 6. Merchandise not as described

Quantity	Item Number	Description	Reason For Return	Return Code

IN EXCHANGE:

Quantity	Item Number	Description	Price

5 47/64"

Size (inches)	ID	OD	PartNumber	Quantity Per Roll	Rolls Per Carton	Carton Weight
8.375" x 12.8125"	3"	8"	10007333*	1,570	ff	41 lbs

* Perforation between labels

Stock - ships within one business day, Made to order - ships within 6 business days.
Prices effective January 2015 - All prices subject to change without notice.

Need a custom solution? Call for a quote today: +1 866 230 9495



SEE MORE.
DO MORE.

RFID

For use with R110Xi4, RZ400 and RZ600 printers

Belt RFID Label

A thermal transfer RFID paper label with a permanent acrylic adhesive. This item is suitable for apparel and supply chain management applications, including the labeling of corrugate and plastic packaging materials. The EPC Class 1 Gen 2, 128 bit inlay operates at a frequency of 860-960 MHz.

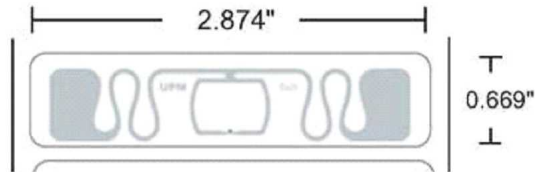

Size (inches)	ID	OD	PartNumber	Quantity Per Roll	Rolls Per Carton	Carton Weight	Stock MTO	Ribbon
2.874" x .669"	3"	8"	10015350	5,000	1	5 lbs.	Stock	06100BK08045

DogBone RFID Label

A thermal transfer RFID paper label with a permanent acrylic adhesive. This item is suitable for apparel and supply chain management applications, including the labeling of corrugate and plastic packaging materials. The EPC Class 1 Gen 2, 128 bit inlay operates at a frequency of 860-960 MHz.

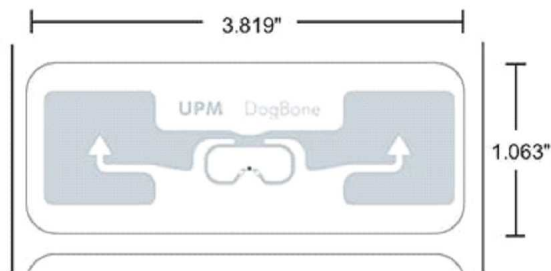

Size (inches)	ID	OD	PartNumber	Quantity Per Roll	Rolls Per Carton	Carton Weight	Stock MTO	Ribbon
3.819" x 1.063"	3"	8"	10015351	3,000	1	6 lbs.	Stock	06100BK11045

ShortDipole RFID Label

A thermal transfer RFID paper label with a permanent acrylic adhesive. This item is suitable for apparel and supply chain management applications, including the labeling of corrugate and plastic packaging materials. The EPC Class 1 Gen 2, 128 bit inlay operates at a frequency of 860-960 MHz.

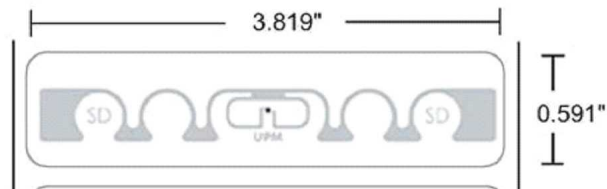

Size (inches)	ID	OD	PartNumber	Quantity Per Roll	Rolls Per Carton	Carton Weight	Stock MTO	Ribbon
3.819" x .591"	3"	8"	10015352	5,000	1	6 lbs.	Stock	06100BK11045

Stock - ships within one business day, Made to order - ships within 6 business days.
Prices effective January 2015 - All prices subject to change without notice.

Need a custom solution? Call for a quote today: +1 866 230 9495



SEE MORE.
DO MORE.

Listing of Ribbons

Manufacturing, Transportation & Logistics Price List

Ribbon Part Number	Width (inches)	Width (mm)	Quantity Per Carton	Weight
6000 WAX (1,476 ft./450m)				
06000BK06045	2.36"	60mm	24	23 lbs.
06000BK08345	3.27"	83mm	24	24 lbs.
06000BK10245	4.02"	102mm	24	26 lbs.
06000BK11045	4.33"	110mm	24	32 lbs.
6100 WAX/RESIN (1,476 ft./450m)				
06100BK08045	3.15"	80mm	6	6 lbs.
06100BK11045	4.33"	110mm	6	7 lbs.
06100BK13145	5.16"	131mm	6	9 lbs.
6200 RESIN (1,476 ft./450m)				
06200BK04045	1.57"	40mm	6	4 lbs.
06200BK06045	2.36"	60mm	6	5 lbs.
06200BK08345	3.27"	83mm	6	6 lbs.
06200BK11045	4.33"	110mm	6	7 lbs.
5100 RESIN (1,476 ft./450m)				
05100BK04045	1.57"	40mm	6	16 lbs.
05100BK06045	2.36"	60mm	6	23 lbs.
05100BK08345	3.27"	83mm	6	22 lbs.
05100BK11045	4.33"	110mm	6	27 lbs.
Red Resin (984ft./300m)				
74801	4.33"	110mm	24	21 lbs.
74802	6.06"	154mm	12	17 lbs.

MINIMUM ORDER QUANTITY FOR ALL RIBBONS IS 1 CARTON.

*Stock - ships within one business day, Made to order - ships within 6 business days.
Prices effective January 2015 - All prices subject to change without notice.*

Need a custom solution? Call for a quote today: **+1 866 230 9495**



DELIVERED PROFITABILITY. EMPOWERED WORKFORCE.

Zebra gives a digital voice to drivers,
routes and deliveries.



Zebra's RW 420—the mobile printer designed to keep every route driver moving. Looking to drive profitability in your direct store delivery operation? Then it's time you looked at Zebra mobile printers and supplies. Our solutions automate invoice and receipt creation, so drivers can cover more territory in every shift and get more profit from every stop.

Improve your bottom line—www.zebra.com/dsd

©2011 ZIH Corp. All rights reserved.



SEE MORE. DO MORE.



www.L-TronDirect.com

800-830-9523

info@L-Tron.com

596 Fishers Station Dr | Victor, NY | 14564 | Suite 1 A

www.L-Tron.com

Get in touch with us
on social media!

