



# Zebra Healthcare Supplies Catalog



SEE MORE. DO MORE.



Zebra has the right labels for hospital applications. Genuine Zebra® labels are available in a range of sizes, materials and adhesives that can withstand all types of testing and storage requirements. Our labels are suitable for labeling all shapes and sizes of specimen containers, including test tubes, vials, microscope slides, petri dishes, and cassettes—plus pharmacy unit dose containers, including syringes and IV bags. Zebra even offers special blood bag labels that meet ISBT 128 compliance requirements.

Effective January 2015



SEE MORE.  
DO MORE.

# Table of Contents

## Healthcare Price List

### Lab

MISYS/Sunquest .....	3
Microscope Slide .....	4
General .....	5

<b><u>ISBT 128</u></b> .....	7
------------------------------	---

### **Mobile Specimen Collection**

Cerner, McKesson, Siemens.....	8
Cerner Aliquot Label .....	9
Meditech .....	10
Meditech Aliquot Label .....	11
IQ Color.....	12

<b><u>Pharmacy</u></b> .....	13
------------------------------	----

### **Breast Milk Tracking**

Cerner, McKesson, Siemens.....	14
Meditech .....	15
CareFusion .....	16

<b><u>Multipurpose</u></b> .....	17
----------------------------------	----

### **Specialty**

Radiology .....	20
Sterilization .....	21
Asset Tracking .....	22

### **Wristbanding**

HC100 Wristband Cartridges.....	23
Wristbands for Desktop and Industrial/Tabletop Printers.....	28

### **Wristbanding – Non-Printable**

Alert Solutions.....	35
OmniBand.....	38
Vinyl Infant Wristband Solutions .....	39
ComfyCuff Solution .....	40

<b><u>Ribbons</u></b> .....	42
-----------------------------	----



SEE MORE.  
DO MORE.

## Catalog Updates

### ***New Items***

#### **Mobile Specimen Collection: IQ Color**

**IQ Color 2000D (p. 12)**

10020397

#### **Wristbanding**

**Z-Band Fusion Infant ID Tags (p. 32)**

FID-BABY-T-1-500, FID-BABY-T-3-1M

#### **Wristbanding: Non-Printable**

**Vinyl Infant Wristband Solutions (p. 39)**

PS-BABY, PS-INFANT-ADJ

**ComfyCuff Solution (p. 46)**

LB2-BABY-P, LB2-BABY-CCS, LB2-BABY-SWB9

### ***Discontinued Items***

#### **Breast Milk Tracking: Meditech**

**PolyPro 4000D**

10017581, 10017582



SEE MORE.  
DO MORE.

# Lab

## MISYS/Sunquest

### 8000D Lab

A direct thermal paper label with a permanent acrylic adhesive specifically designed to adhere to small, curved surfaces.

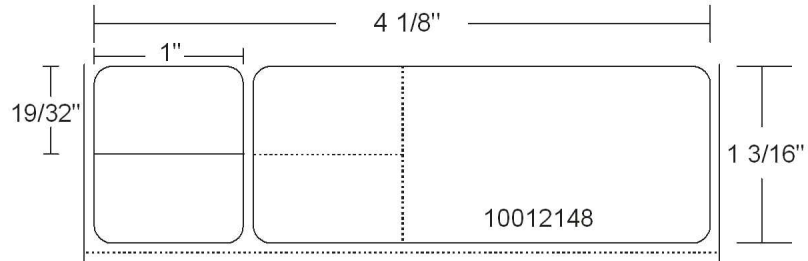

Size (inches)	PartNumber	ID	OD	Stock MTO	Carton Weight	Color	Quantity Per Roll	Rolls Per Carton
4.125" x 1.1875"	10012148	1"	5"	Stock	20 lbs.	White	2,000	4

Stock - ships within one business day, Made to order - ships within 6 business days.  
Prices effective January 2015 - All prices subject to change without notice.

Need a custom solution? Call for a quote today: +1 866 230 9495



SEE MORE.  
DO MORE.

Lab

Microscope Slide

**PolyPro 4000T**

A thermal transfer Kimdura® polypropylene label with a permanent acrylic adhesive.

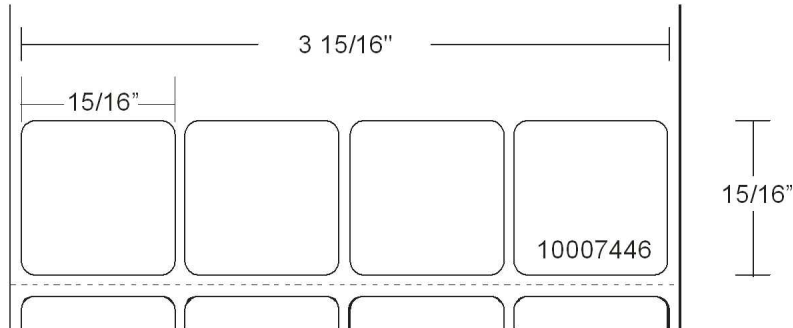

Size (inches)	PartNumber	ID	OD	Quantity Per Roll	Rolls Per Carton	Carton Weight	Stock MTO	Ribbon
0.9375" x 0.9375"	10007446	1"	5"	1,900	6	10 lbs.	Stock	06100GS06407

**Z-Xtreme 5000T**

A thermal transfer, coated label with a high performance acrylic adhesive that will stay put on difficult-to-label surfaces.

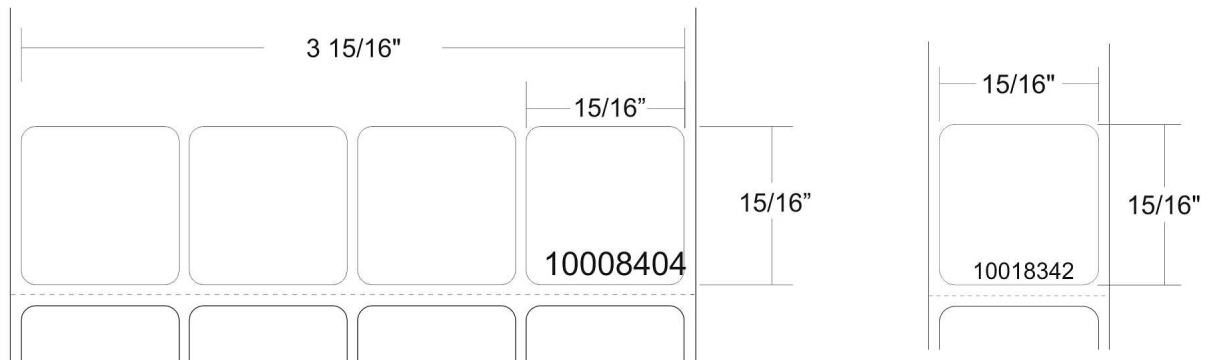

Size (inches)	PartNumber	ID	OD	Quantity Per Roll	Rolls Per Carton	Carton Weight	Stock MTO	Ribbon
0.9375" x 0.9375"	10008404	1"	5"	2,190	4	6 lbs.	Stock	74943
0.9375" x 0.9375"	10018342	1"	5"	2,195	4	4 lbs.	MTO	74941

Stock - ships within one business day, Made to order - ships within 6 business days.  
Prices effective January 2015 - All prices subject to change without notice.

Need a custom solution? Call for a quote today: +1 866 230 9495



SEE MORE.  
DO MORE.

# Lab

## General

### 8000D Lab

A direct thermal paper label with a high-tack permanent acrylic adhesive specifically designed to adhere to small, curved surfaces.

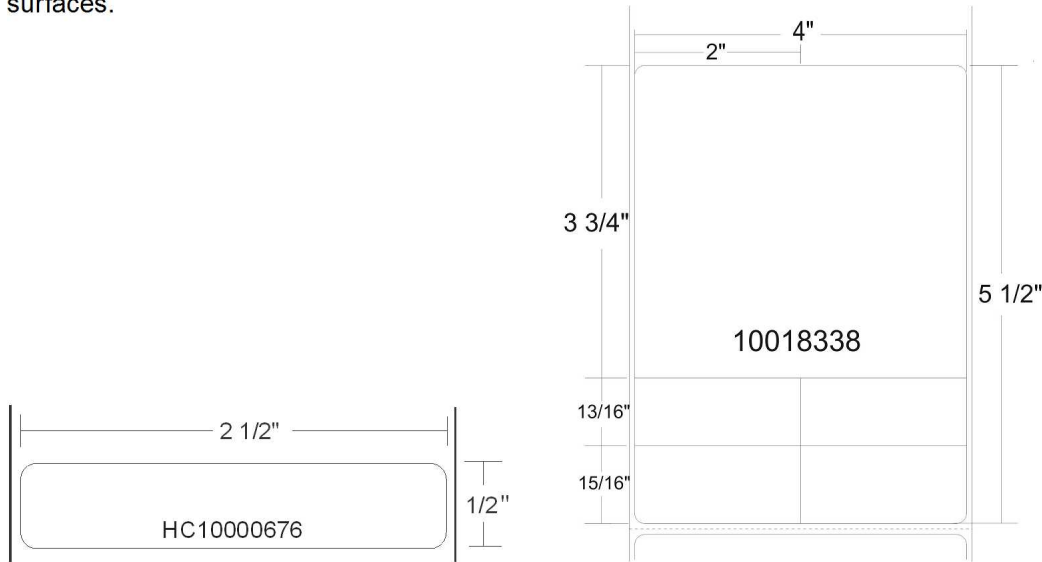

Size (inches)	PartNumber	ID	OD	Color	Quantity Per Roll	Rolls Per Carton	Carton Weight	Stock MTO
2.5" x 0.5"	HC10000676	3"	8"	White	9,220	6	30 lbs.	MTO
4" x 5.5"	10018338	3"	8"	White	1,050	4	26 lbs.	Stock

### PolyPro 4000D

A direct thermal polypropylene label with an all-temp permanent acrylic adhesive.

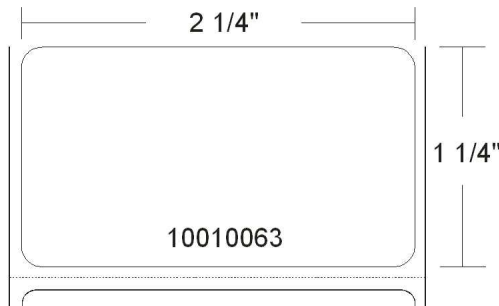

Size (inches)	PartNumber	ID	OD	Quantity Per Roll	Rolls Per Carton	Carton Weight	Stock MTO
2.25" x 1.25"	10010063	1"	5"	2,000	6	12 lbs.	Stock

Stock - ships within one business day, Made to order - ships within 6 business days.  
Prices effective January 2015 - All prices subject to change without notice.

Need a custom solution? Call for a quote today: +1 866 230 9495



SEE MORE.  
DO MORE.

# Lab

## General

### PolyPro 4000T

A thermal transfer Kimdura® polypropylene label with a permanent acrylic adhesive.

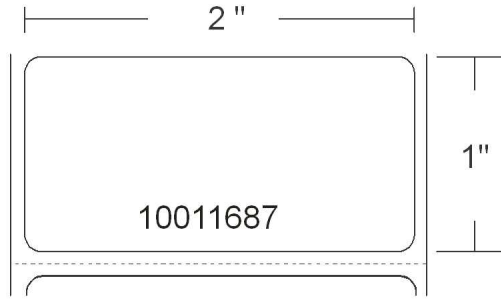

Size (inches)	PartNumber	ID	OD	Quantity Per Roll	Rolls Per Carton	Carton Weight	Stock MTO	Ribbon
2" x 1"	10014716	3"	8"	3,940	4	10 lbs.	Stock	06100BK06045

Stock - ships within one business day, Made to order - ships within 6 business days.  
Prices effective January 2015 - All prices subject to change without notice.

Need a custom solution? Call for a quote today: +1 866 230 9495





SEE MORE.  
DO MORE.

# ISBT 128

## General

### 8000T Primary Blood Bag Label

A thermal transfer polypropylene label with a permanent acrylic adhesive for direct application to a blood bag.

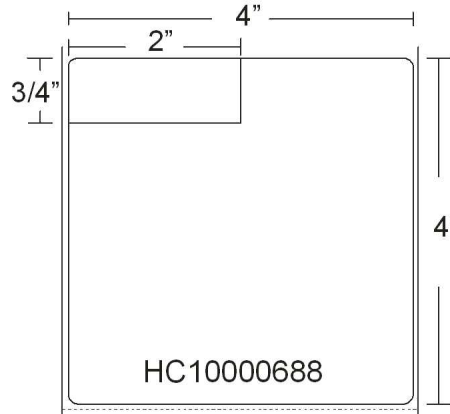

Size (inches)	PartNumber	ID	OD	Quantity Per Roll	Rolls Per Carton	Carton Weight	Stock MTO	Ribbon
4" x 4"	HC10000688	3"	8"	1,110	4	24 lbs.	Stock	06100BK11045

Stock - ships within one business day, Made to order - ships within 6 business days.  
Prices effective January 2015 - All prices subject to change without notice.

Need a custom solution? Call for a quote today: +1 866 230 9495





SEE MORE.  
DO MORE.

# Mobile Specimen Collection

Cerner, McKesson, Siemens

## 8000D Lab

A direct thermal paper label with a permanent acrylic adhesive specifically designed to adhere to small, curved surfaces.

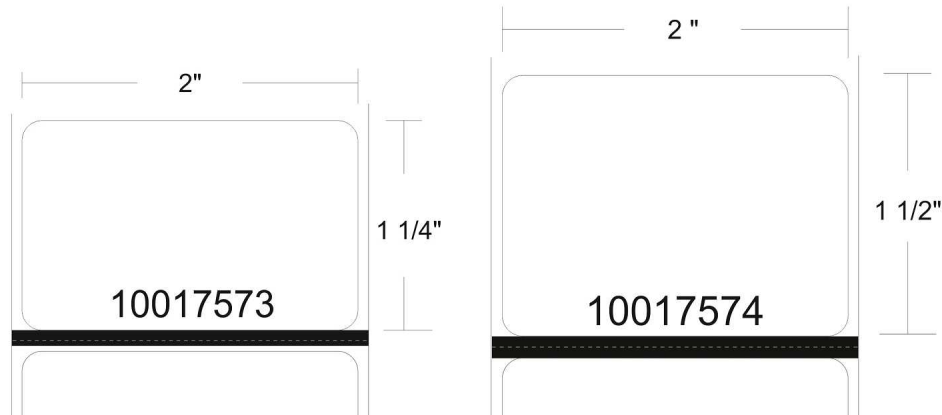

Size (inches)	PartNumber	ID	OD	Quantity Per Roll	Rolls Per Carton	Carton Weight	Stock MTO
2" x 1.25"	10017573	0.75"	2.2"	330	12	3 lbs.	Stock
2" x 1.5"	10017574	0.75"	2.2"	280	12	3 lbs.	Stock

## PolyPro 4000D

A direct thermal polypropylene label with an all-temp permanent acrylic adhesive.

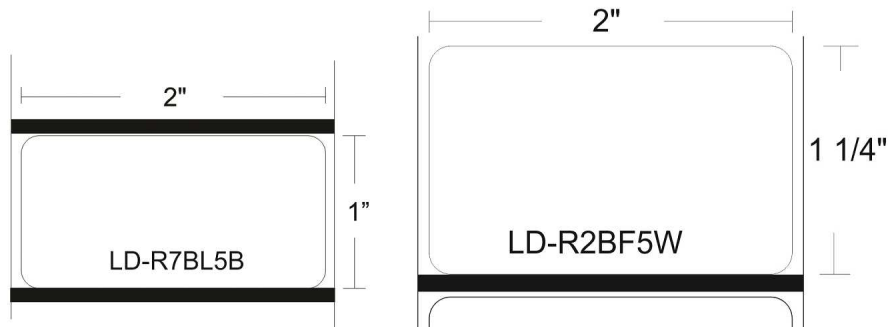

Size (inches)	PartNumber	ID	OD	Quantity Per Roll	Rolls Per Carton	Carton Weight	Stock MTO
2" x 1"	LD-R7BL5B	0.75"	2"	350	36	7 lbs.	Stock
2" x 1.25"	LD-R2BF5W	0.75"	2"	280	36	8 lbs.	Stock

Stock - ships within one business day, Made to order - ships within 6 business days.  
Prices effective January 2015 - All prices subject to change without notice.

Need a custom solution? Call for a quote today: +1 866 230 9495



SEE MORE.  
DO MORE.

# Mobile Specimen Collection

## Cerner Aliquot Label

### 8000D Lab

A direct thermal paper label with a permanent acrylic adhesive specifically designed to adhere to small, curved surfaces.

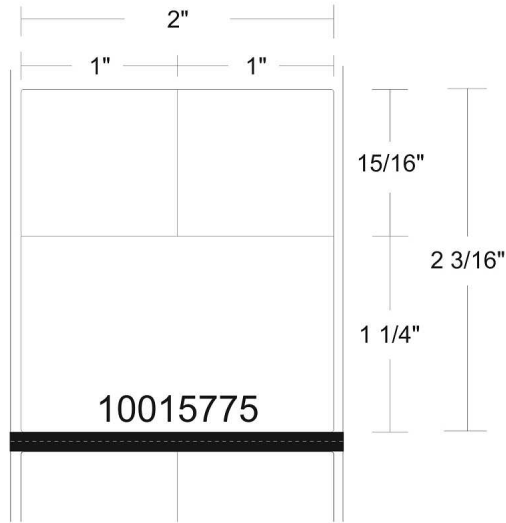

Size (inches)	PartNumber	ID	OD	Quantity Per Roll	Rolls Per Carton	Carton Weight	Stock MTO
2" x 2.1875"	10015775	0.75"	2.2"	200	12	5 lbs.	Stock

Stock - ships within one business day, Made to order - ships within 6 business days.  
Prices effective January 2015 - All prices subject to change without notice.

Need a custom solution? Call for a quote today: +1 866 230 9495



SEE MORE.  
DO MORE.

# Mobile Specimen Collection

## Meditech

### 8000D Lab

A direct thermal paper label with a permanent acrylic adhesive specifically designed to adhere to small, curved surfaces.

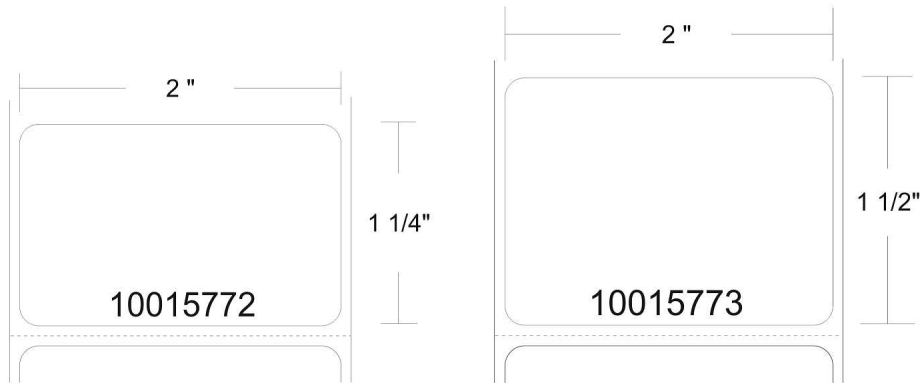

Size (inches)	PartNumber	ID	OD	Quantity Per Roll	Rolls Per Carton	Carton Weight	Stock MTO
2" x 1.25"	10015772	0.75"	2.2"	330	12	3 lbs.	Stock
2" x 1.5"	10015773	0.75"	2.2"	280	12	3 lbs.	Stock

### PolyPro 4000D

A direct thermal polypropylene label with an all-temp permanent acrylic adhesive.



Size (inches)	PartNumber	ID	OD	Quantity Per Roll	Rolls Per Carton	Carton Weight	Stock MTO
2" x 1.25"	10015778	0.75"	2.2"	380	12	3 lbs.	Stock

Stock - ships within one business day, Made to order - ships within 6 business days.  
Prices effective January 2015 - All prices subject to change without notice.

Need a custom solution? Call for a quote today: +1 866 230 9495



SEE MORE.  
DO MORE.

# Mobile Specimen Collection

## Meditech Aliquot Label

### 8000D Lab

A direct thermal paper label with a permanent acrylic adhesive specifically designed to adhere to small, curved surfaces.

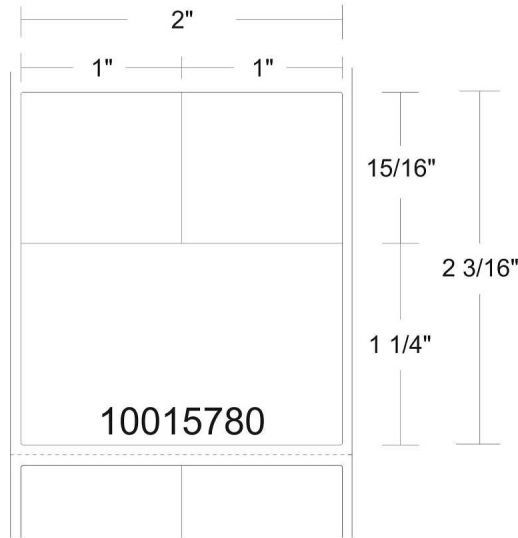

Size (inches)	PartNumber	ID	OD	Quantity Per Roll	Rolls Per Carton	Carton Weight	Stock MTO
2" x 2.1875"	10015780	0.75"	2.2"	200	12	3 lbs.	Stock

Stock - ships within one business day, Made to order - ships within 6 business days.  
Prices effective January 2015 - All prices subject to change without notice.

Need a custom solution? Call for a quote today: +1 866 230 9495



SEE MORE.  
DO MORE.

# Mobile Specimen Collection

## IQ Color Specimen Collection Label

### IQ Color 2000D

A white, coated direct thermal paper label with a permanent acrylic adhesive which allows the ability to print vibrant color on-demand in pre-defined zones to be used as a visual cue.



Size (inches)	PartNumber	ID	OD	Quantity Per Roll	Rolls Per Carton	Carton Weight	Stock MTO
2" x 1"	10020397	0.75"	2.2"	450	36	18 lbs.	Stock

Red color zone runs along the left edge of the label and measures 0.25" wide x 1" long.  
Black mark sensing and perforations between labels.

*Stock - ships within one business day, Made to order - ships within 6 business days.  
Prices effective January 2015 - All prices subject to change without notice.*

Need a custom solution? Call for a quote today: +1 866 230 9495



SEE MORE.  
DO MORE.

# Pharmacy

## General

### Z-Select 4000D

A direct thermal, bright white coated paper label with an all-temp permanent acrylic adhesive.

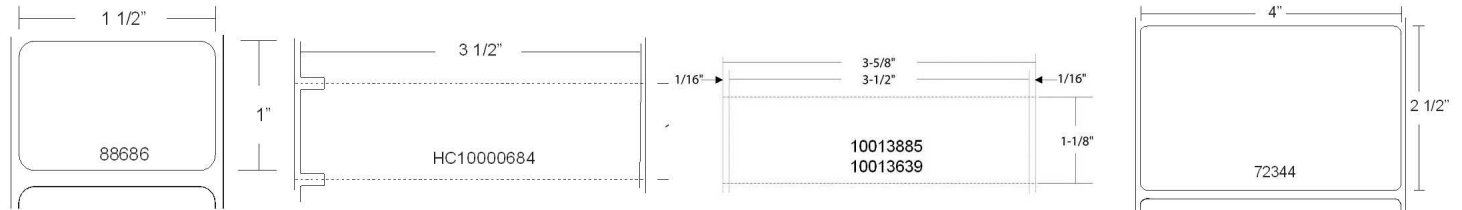

Size (inches)	PartNumber	ID	OD	Quantity Per Roll	Rolls Per Carton	Carton Weight	Stock MTO
1.5" x 1"	88686	3"	8"	5,120	14	29 lbs.	Stock
3.5" x 1"	HC10000684*	3"	8"	5,760	6	30 lbs.	Stock
3.5" x 1.125"	10013639	3"	8"	5,219	6	30 lbs.	MTO
3.5" x 1.125"	10013885	1"	5"	2,374	4	10 lbs.	MTO
4" x 2.5"	72344	3"	8"	2,220	4	24 lbs.	Stock

\*This label has notches on the left side. Printable area is 3.5" x 0.875".

### Z-Select 4000T

A premium, thermal transfer, bright white, coated, ultra-smooth paper label with a permanent acrylic adhesive.

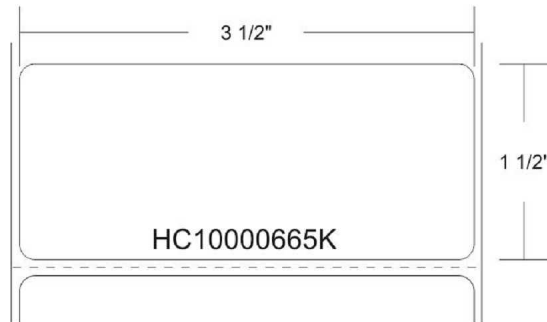

Size (inches)	PartNumber	ID	OD	Quantity Per Roll	Rolls Per Carton	Carton Weight	Stock MTO
3.5" x 1.5"	HC10000665K*	1"	5"	1,570	3	15 lbs.	Stock

\*Kit includes 3 rolls of labels and 3 rolls of ribbon part number 05319GS11007. Perforations between labels.



SEE MORE.  
DO MORE.

# Breast Milk Tracking

Cerner, McKesson, Siemens

## PolyPro 4000D

A direct thermal polypropylene label with an all-temp permanent acrylic adhesive. For use in water temperatures up to 160°F.

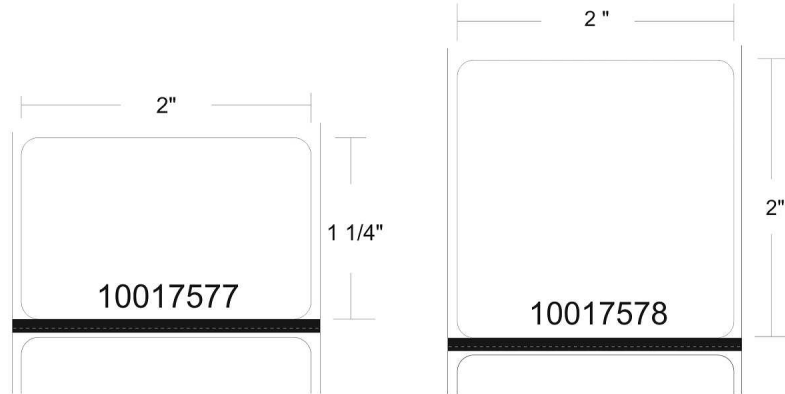

Size (inches)	PartNumber	ID	OD	Quantity Per Roll	Rolls Per Carton	Carton Weight	Stock MTO
2" x 1.25"	10017577	0.75"	2.2"	380	12	3 lbs.	Stock
2" x 2"	10017578	0.75"	2.2"	245	12	3 lbs.	Stock

Labels equipped with protective overvarnish.

## PolyPro 4000T

A thermal transfer Kimdura® polypropylene label with a permanent acrylic adhesive. For use in water temperatures over 160°F.

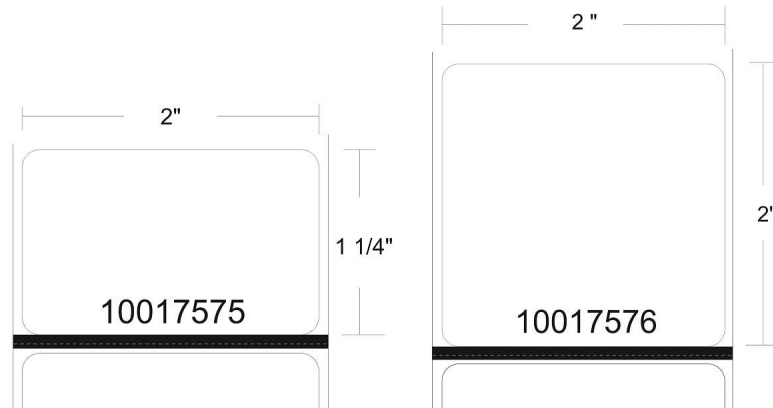

Size (inches)	PartNumber	ID	OD	Quantity Per Roll	Rolls Per Carton	Carton Weight	Stock MTO	Ribbon
2" x 1.25"	10017575	0.75"	2.6"	375	12	3 lbs.	Stock	05555BK110D
2" x 2"	10017576	0.75"	2.6"	245	12	3 lbs.	Stock	05555BK110D

Stock - ships within one business day, Made to order - ships within 6 business days.  
Prices effective January 2015 - All prices subject to change without notice.

Need a custom solution? Call for a quote today: +1 866 230 9495





SEE MORE.  
DO MORE.

# Breast Milk Tracking

## Meditech

### PolyPro 4000T

A thermal transfer Kimdura® polypropylene label with a permanent acrylic adhesive. For use in water temperatures over 160°F.

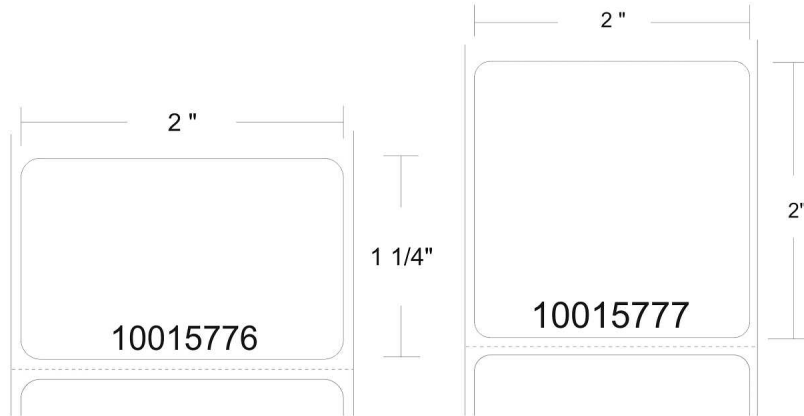

Size (inches)	PartNumber	ID	OD	Quantity Per Roll	Rolls Per Carton	Carton Weight	Stock MTO	Ribbon
2" x 2"	10015777	0.75"	2.6"	245	12	3 lbs.	Stock	05555BK110D
2" x 1.25"	10015776	0.75"	2.6"	375	12	3 lbs.	Stock	05555BK110D

Stock - ships within one business day, Made to order - ships within 6 business days.  
Prices effective January 2015 - All prices subject to change without notice.

Need a custom solution? Call for a quote today: +1 866 230 9495



SEE MORE.  
DO MORE.

# Breast Milk Tracking

## CareFusion

### Z-Ultimate 4000T

A thermal transfer, pearl white, gloss polyester label with a high performance acrylic adhesive. Provides unparalleled smear and scratch resistance and resistance to moderate chemicals.

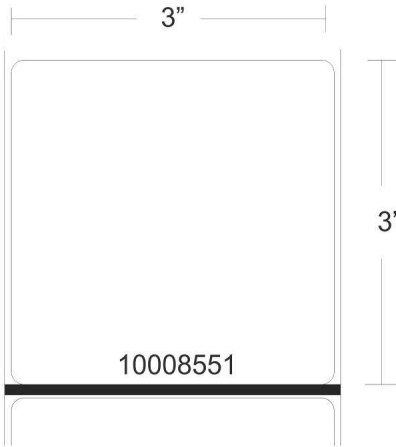

Size (inches)	PartNumber	ID	OD	Quantity Per Roll	Rolls Per Carton	Carton Weight	Stock MTO	Ribbon
3" x 3"	10008551	0.75"	2.6"	230	12	16 lbs.	Stock	06200BK08345

Stock - ships within one business day, Made to order - ships within 6 business days.  
Prices effective January 2015 - All prices subject to change without notice.

Need a custom solution? Call for a quote today: +1 866 230 9495



SEE MORE.  
DO MORE.

# Multipurpose

## General

### Z-Perform 2000D

A white, coated direct thermal paper label with an all-temp permanent acrylic adhesive.

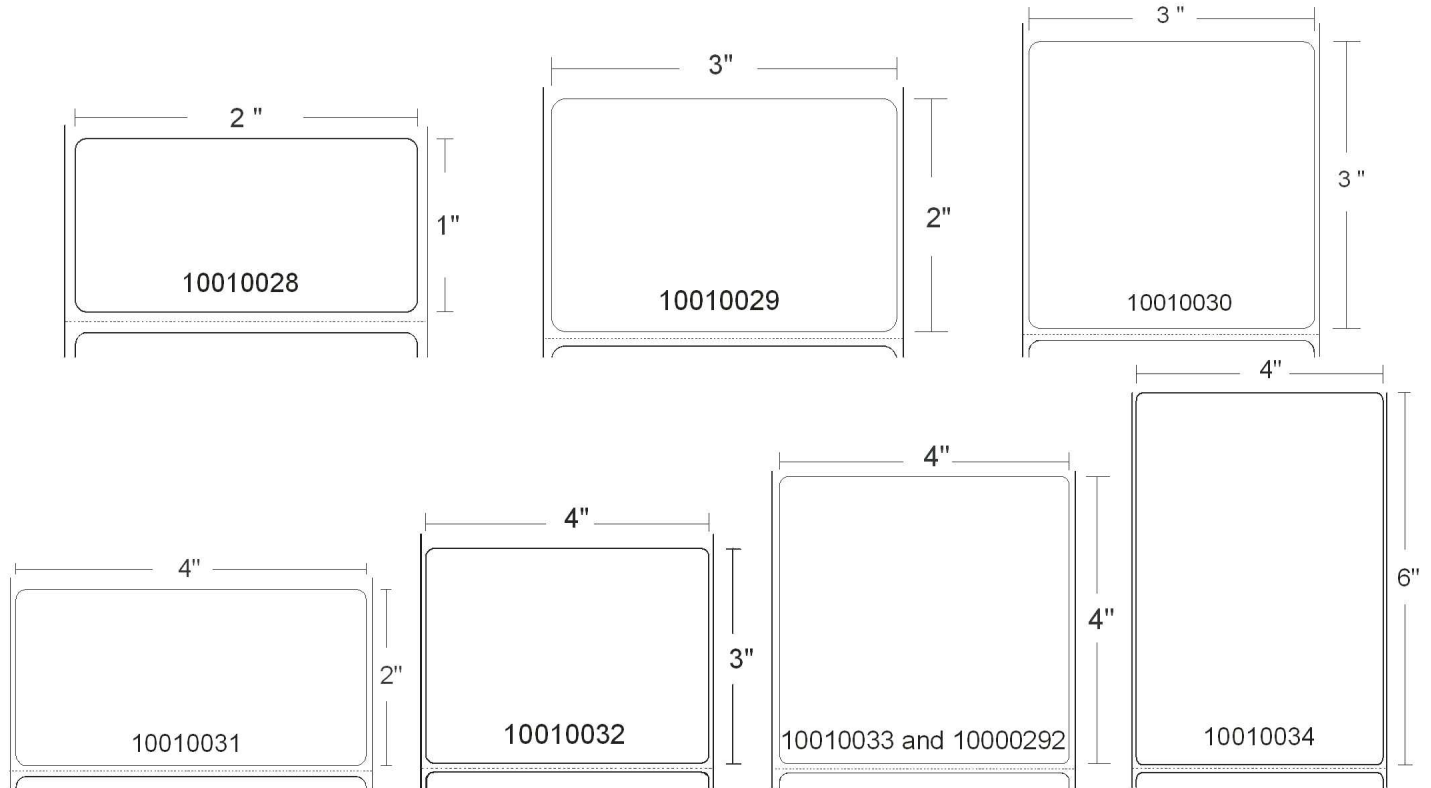

Size (inches)	PartNumber	ID	OD	Quantity Per Roll	Rolls Per Carton	Carton Weight	Stock MTO
2" x 1"	10010028	1"	5"	2,340	6	10 lbs	Stock
3" x 2"	10010029	1"	5"	1,240	6	11 lbs.	Stock
3" x 3"	10010030	1"	5"	840	6	11 lbs.	Stock
4" x 2"	10010031	1"	5"	1,240	6	12 lbs.	Stock
4" x 3"	10010032	1"	5"	840	6	12 lbs.	Stock
4" x 4"	10000292	3"	8"	1,500	4	27 lbs.	Stock
4" x 4"	10010033	1"	5"	640	6	12 lbs.	Stock
4" x 6"	10010034	1"	5"	430	6	12 lbs.	Stock

Stock - ships within one business day, Made to order - ships within 6 business days.  
Prices effective January 2015 - All prices subject to change without notice.

Need a custom solution? Call for a quote today: +1 866 230 9495



SEE MORE.  
DO MORE.

# Multipurpose

## General

### Z-Perform 2000D Floodcoated

A coated direct thermal paper label with an all-temp permanent acrylic adhesive.

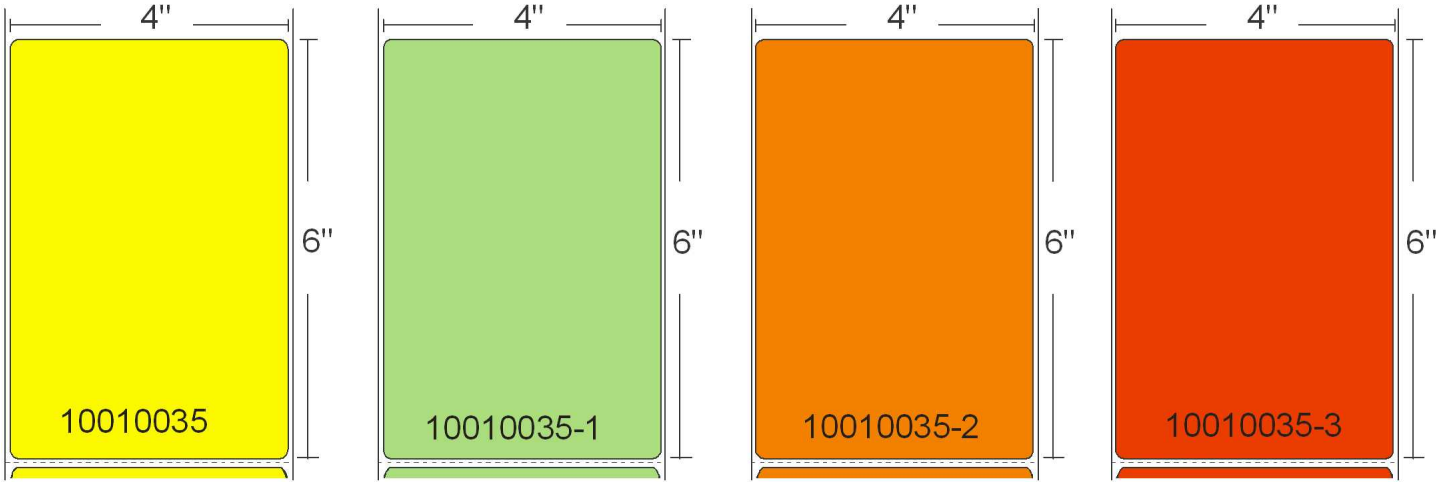

Size (inches)	PartNumber	ID	OD	Color	Quantity Per Roll	Rolls Per Carton	Carton Weight	Stock MTO
4" x 6"	10010035	1"	5"	Yellow	430	6	12 lbs.	Stock
4" x 6"	10010035-1	1"	5"	Green	430	6	12 lbs.	Stock
4" x 6"	10010035-2	1"	5"	Orange	430	6	12 lbs.	Stock
4" x 6"	10010035-3	1"	5"	Red	430	6	12 lbs.	Stock

Stock - ships within one business day, Made to order - ships within 6 business days.  
Prices effective January 2015 - All prices subject to change without notice.

Need a custom solution? Call for a quote today: +1 866 230 9495



SEE MORE.  
DO MORE.

# Multipurpose

## General

### Z-Select 4000D

A direct thermal, bright white coated paper label with an all-temp permanent acrylic adhesive

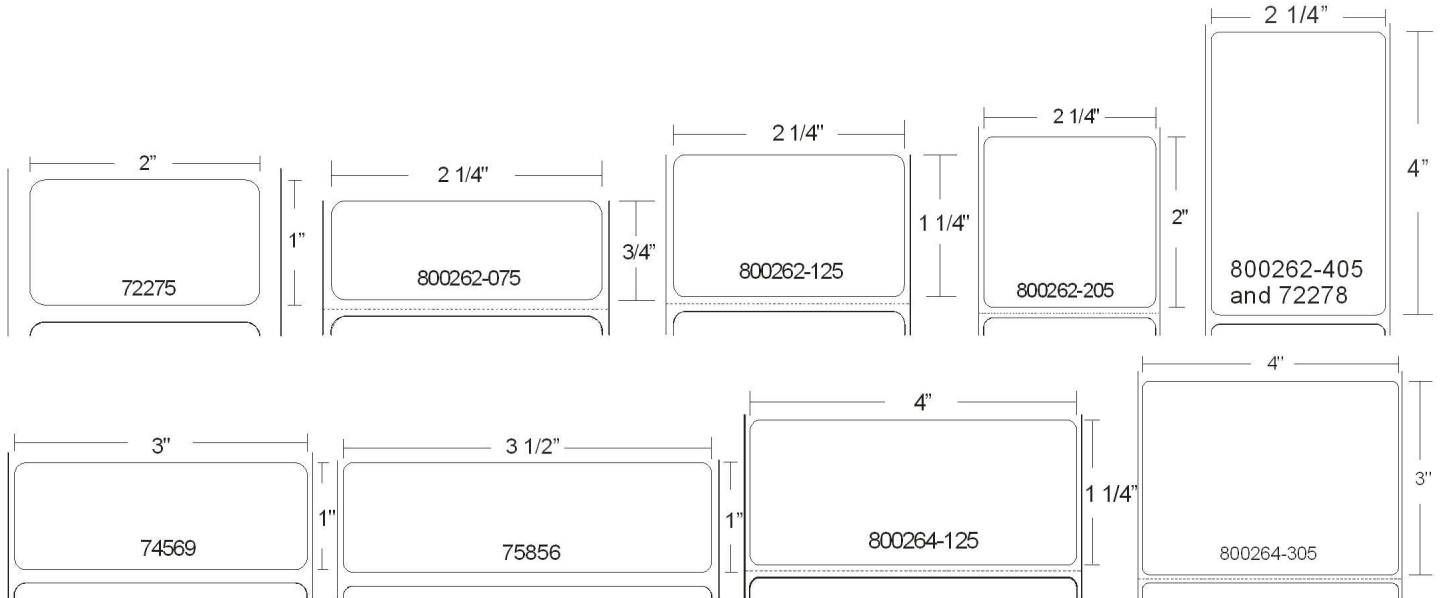

Size (inches)	PartNumber	ID	OD	Quantity Per Roll	Rolls Per Carton	Carton Weight	Stock MTO
2" x 1"	72275	3"	8"	4,620	8	22 lbs.	Stock
2.25" x 0.75"	10015340	1"	5"	3,315	12	20 lbs.	Stock
2.25" x 1.25"	10015341	1"	5"	2,100	12	20 lbs.	Stock
2.25" x 2"	10015342	1"	5"	1,370	12	20 lbs.	Stock
2.25" x 4"	10015343	1"	5"	700	12	20 lbs.	Stock
2.25" x 4"	72278	3"	8"	1,260	8	25 lbs.	Stock
3" x 1"	74569	3"	8"	5,120	6	24 lbs.	Stock
3.5" x 1"	75856	3"	8"	5,120	6	29 lbs.	Stock
4" x 1.25"	10015349	1"	5"	2,100	12	28 lbs.	Stock
4" x 3"	10015344	1"	5"	930	12	30 lbs.	Stock

Stock - ships within one business day, Made to order - ships within 6 business days.  
Prices effective January 2015 - All prices subject to change without notice.

Need a custom solution? Call for a quote today: +1 866 230 9495



SEE MORE.  
DO MORE.

# Specialty

## Radiology

### Z-Select 4000D

A direct thermal, bright white coated paper label with an all-temp permanent acrylic adhesive

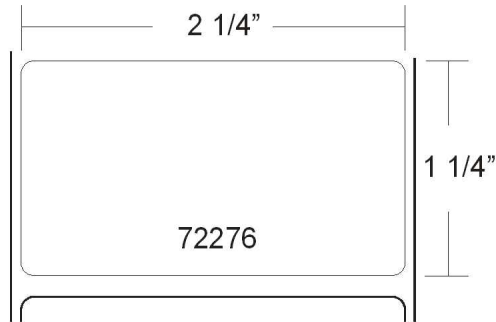

Size (inches)	PartNumber	ID	OD	Quantity Per Roll	Rolls Per Carton	Carton Weight	Stock MTO
2.25" x 1.25"	72276	3"	8"	3,770	8	24 lbs.	Stock

Stock - ships within one business day, Made to order - ships within 6 business days.  
Prices effective January 2015 - All prices subject to change without notice.

Need a custom solution? Call for a quote today: +1 866 230 9495



SEE MORE.  
DO MORE.

# Specialty

## Sterilization

### Z-Ultimate 2000T White

A pearl white, gloss polyester thermal transfer label with a high performance permanent acrylic adhesive

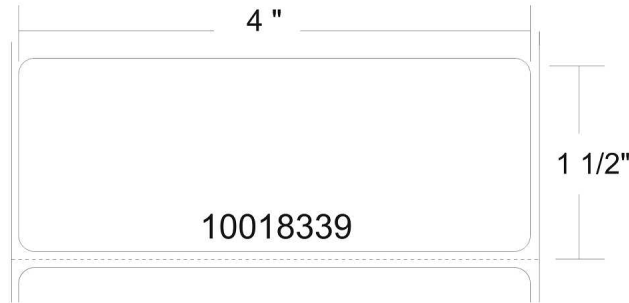

Size (inches)	PartNumber	ID	OD	Quantity Per Roll	Rolls Per Carton	Carton Weight	Stock MTO	Ribbon
4" x 1.5"	10018339	3"	8"	3,800	4	32 lbs.	Stock	06200BK11045

### Z-Ultimate 3000T White

A pearl white, gloss polyester thermal transfer label with a high performance permanent acrylic adhesive

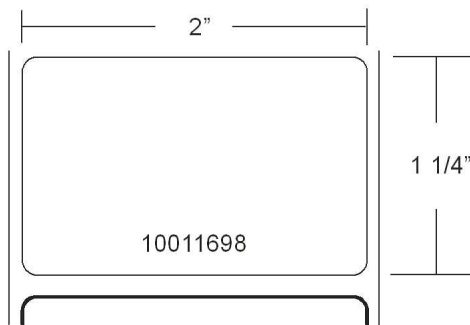

Size (inches)	PartNumber	ID	OD	Quantity Per Roll	Rolls Per Carton	Carton Weight	Stock MTO	Ribbon
2" x 1.25"	10011698	3"	8"	4,270	4	10 lbs.	Stock	06200BK06045

Stock - ships within one business day, Made to order - ships within 6 business days.  
Prices effective January 2015 - All prices subject to change without notice.

Need a custom solution? Call for a quote today: +1 866 230 9495





SEE MORE.  
DO MORE.

# Specialty

## Asset Tracking

### PolyPro 4000T

A thermal transfer Kimdura® polypropylene label with a permanent acrylic adhesive.

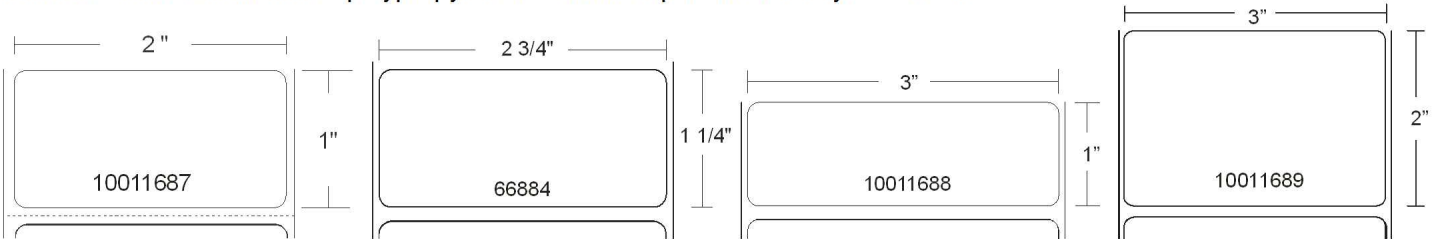

Size (inches)	PartNumber	ID	OD	Quantity Per Roll	Rolls Per Carton	Carton Weight	Stock MTO	Ribbon
2" x 1"	10014716	3"	8"	3,940	4	10 lbs.	Stock	06100BK06045
2.75" x 1.25"	10014717	3"	8"	3,210	4	28 lbs.	Stock	06100BK08045
3" x 1"	10011688	3"	8"	4,350	4	20 lbs.	Stock	06100BK08045
3" x 2"	10011689	3"	8"	2,230	4	20 lbs.	Stock	06100BK08045

Stock - ships within one business day, Made to order - ships within 6 business days.  
Prices effective January 2015 - All prices subject to change without notice.

Need a custom solution? Call for a quote today: +1 866 230 9495



SEE MORE.  
DO MORE.

# Wristbanding

## HC100 Wristband Cartridges

### Z-Band UltraSoft Kit

Ultra-soft and flexible direct thermal polypropylene and vinyl wristband with an adhesive tamper-evident tab for securement. Scannable up to 14 days. Wristbands contained in an easy-to-load cartridge for the HC100 printer.

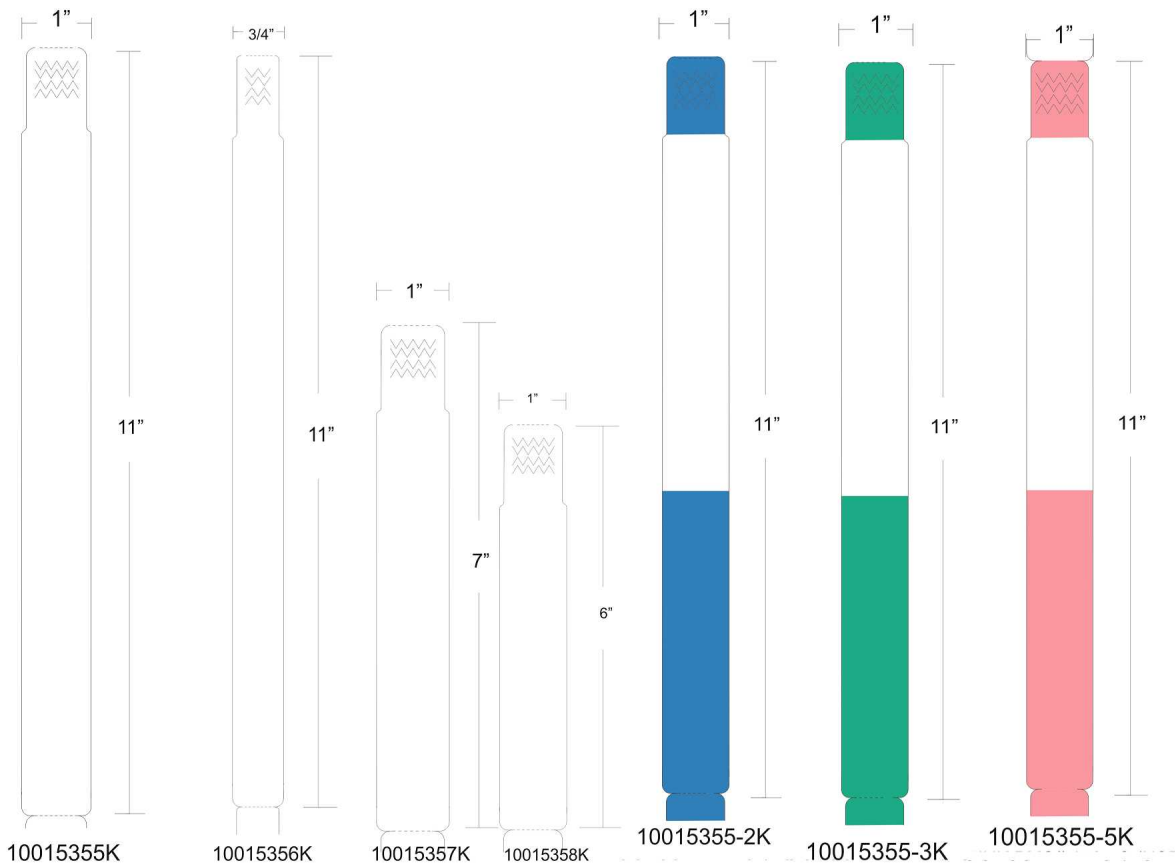

PartNumber	Size (inches)	Color	Quantity Per Roll	Rolls Per Carton	Carton Weight	Stock MTO
10015355-2K	1" x 11"	Blue	175	6	6 lbs.	Stock
10015355-3K	1" x 11"	Green	175	6	6 lbs.	Stock
10015355-5K	1" x 11"	Pink	175	6	6 lbs.	Stock
10015355K	1" x 11"	White	175	6	6 lbs.	Stock
10015356K	0.75" x 11"	White	175	6	6 lbs.	Stock
10015357K	1" x 7"	White	250	6	6 lbs.	Stock
10015358K	1" x 6"	White	300	6	6 lbs.	Stock

Must be ordered in carton quantities. Each part number represents 1 carton.

Stock - ships within one business day, Made to order - ships within 6 business days.  
Prices effective January 2015 - All prices subject to change without notice.

Need a custom solution? Call for a quote today: +1 866 230 9495



SEE MORE.  
DO MORE.

# Wristbanding

## HC100 Wristband Cartridges

### Z-Band Direct Kit

Direct thermal polypropylene wristband with an adhesive tamper-evident tab for securement. Scannable up to 14 days. Wristbands contained in an easy-to-load cartridge for the HC100 printer.

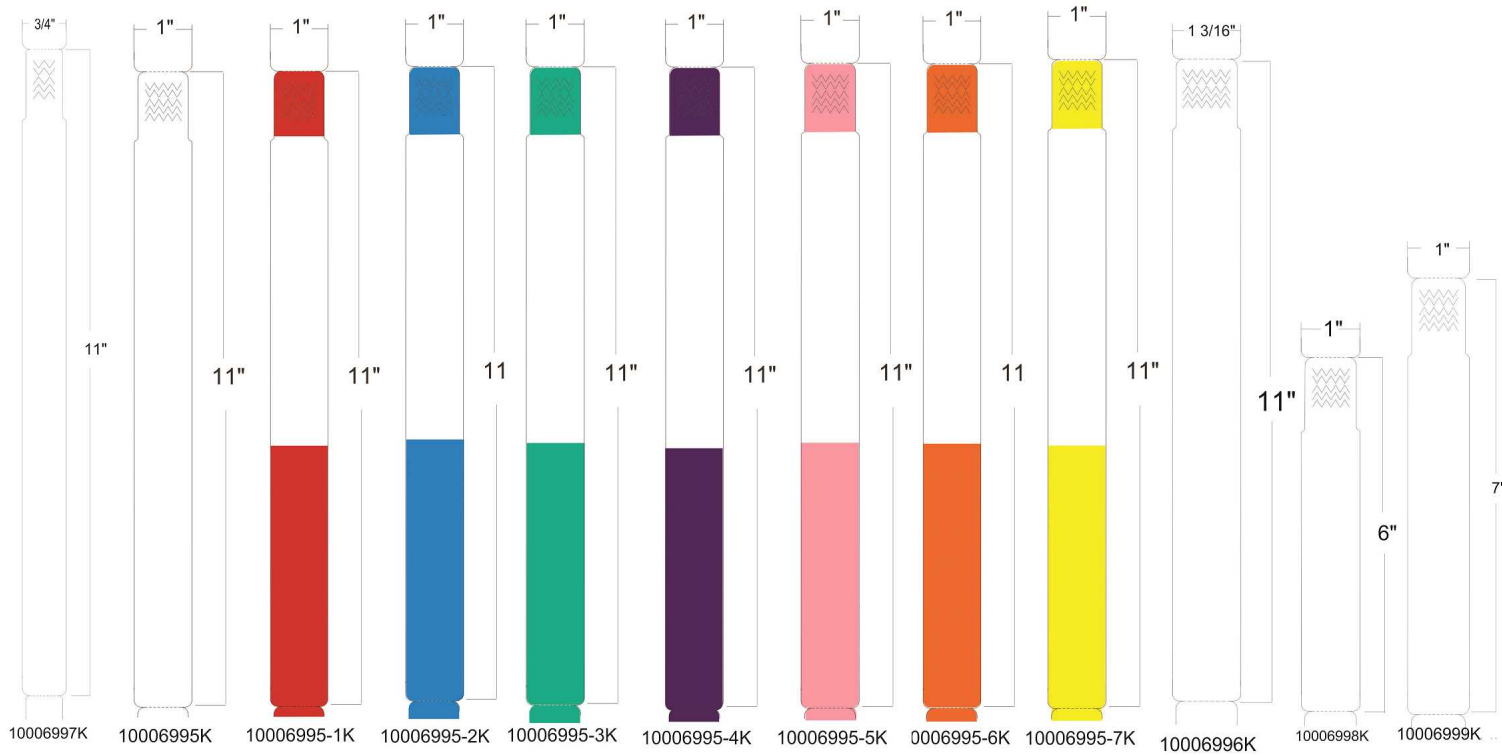

PartNumber	Size (inches)	Color	Quantity Per Roll	Rolls Per Carton	Carton Weight	Stock MTO
10006997K	0.75" x 11"	White	200	6	6 lbs.	Stock
10006995K	1" x 11"	White	200	6	6 lbs.	Stock
10006995-1K	1" x 11"	Red	200	6	6 lbs.	Stock
10006995-2K	1" x 11"	Blue	200	6	6 lbs.	Stock
10006995-3K	1" x 11"	Green	200	6	6 lbs.	Stock
10006995-4K	1" x 11"	Purple	200	6	6 lbs.	Stock
10006995-5K	1" x 11"	Pink	200	6	6 lbs.	Stock
10006995-6K	1" x 11"	Orange	200	6	6 lbs.	Stock
10006995-7K	1" x 11"	Yellow	200	6	6 lbs.	Stock
10006996K	1.1875" x 11"	White	200	6	6 lbs.	Stock
10006998K	1" x 6"	White	350	6	6 lbs.	Stock
10006999K	1" x 7"	White	300	6	6 lbs.	Stock

Must be ordered in carton quantities. Each part number represents 1 carton.

Stock - ships within one business day, Made to order - ships within 6 business days.  
Prices effective January 2015 - All prices subject to change without notice.

Need a custom solution? Call for a quote today: +1 866 230 9495



SEE MORE.  
DO MORE.

# Wristbanding

## HC100 Wristband Cartridges

### Z-Band Comfort Kit

Light-weight and flexible direct thermal polypropylene wristband with an adhesive tamper-evident tab for securement. Scannable up to 7 days. Wristbands contained in an easy-to-load cartridge for the HC100 printer.

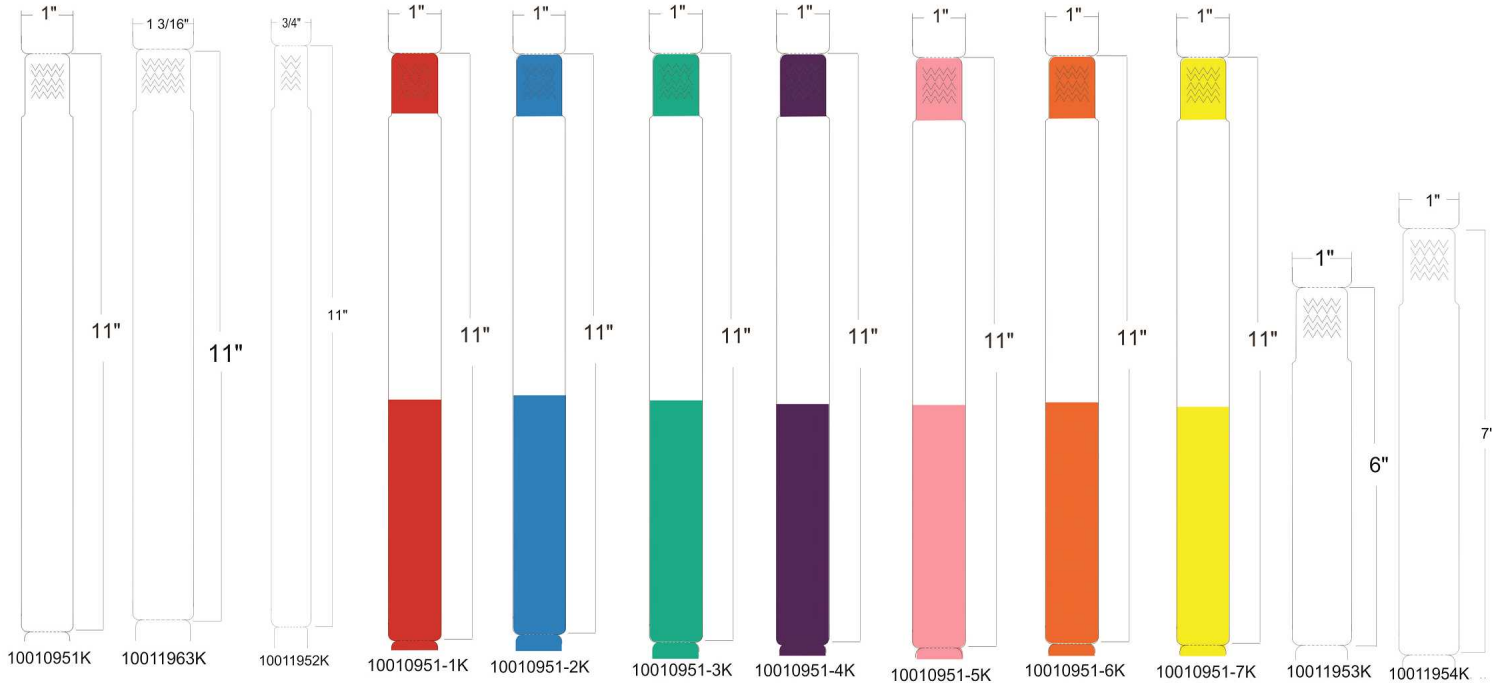

PartNumber	Size (inches)	Color	Quantity Per Roll	Rolls Per Carton	Carton Weight	Stock MTO
10010951K	1" x 11"	White	300	6	6 lbs.	Stock
10011963K	1.875" x 11"	White	300	6	6 lbs.	Stock
10011952K	0.75" x 11"	White	300	6	6 lbs.	Stock
10010951-1K	1" x 11"	Red	300	6	6 lbs.	Stock
10010951-2K	1" x 11"	Blue	300	6	6 lbs.	Stock
10010951-3K	1" x 11"	Green	300	6	6 lbs.	Stock
10010951-4K	1" x 11"	Purple	300	6	6 lbs.	Stock
10010951-5K	1" x 11"	Pink	300	6	6 lbs.	Stock
10010951-6K	1" x 11"	Orange	300	6	6 lbs.	Stock
10010951-7K	1" x 11"	Yellow	300	6	6 lbs.	Stock
10011953K	1" x 6"	White	600	6	6 lbs.	Stock
10011954K	1" x 7"	White	500	6	6 lbs.	Stock

Must be ordered in carton quantities. Each part number represents 1 carton.

Stock - ships within one business day, Made to order - ships within 6 business days.  
Prices effective January 2015 - All prices subject to change without notice.

Need a custom solution? Call for a quote today: +1 866 230 9495



SEE MORE.  
DO MORE.

# Wristbanding

## HC100 Wristband Cartridges

### Soft Infant Z-Band Direct Kit

A direct thermal white polypropylene wristband with soft nylon lining and an adhesive tab for securement. Wristbands contained in an easy-to-load cartridge for the HC100 printer.



Soft infant band with 2.062" L printable area.  
Narrow adhesive tail loops through to attach.

PartNumber	Size (inches)	Color	Quantity Per Roll	Rolls Per Carton	Carton Weight	Stock MTO
10007746K^^	0.75" x 7.6875"	White	275	6	6 lbs.	Stock

^^ Must be ordered in carton quantities. Each part number represents 1 carton.

Stock - ships within one business day, Made to order - ships within 6 business days.  
Prices effective January 2015 - All prices subject to change without notice.

Need a custom solution? Call for a quote today: +1 866 230 9495



SEE MORE.  
DO MORE.

## Wristbanding

### HC100 Wristband Cartridges

#### Z-Band QuickClip Kit

Direct thermal polypropylene wristband with secure clip closures. Scannable up to 14 days. Wristbands contained in an easy-to-load cartridge for the HC100 printer.

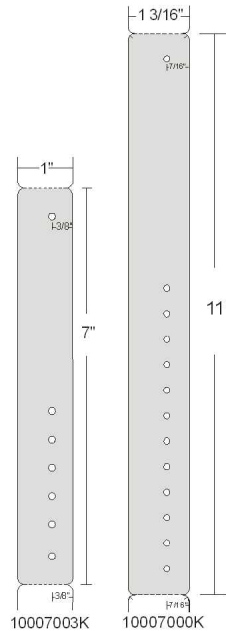

PartNumber	Size (inches)	Color	Quantity Per Roll	Rolls Per Carton	Carton Weight	Stock MTO
10007000K*	1.1875" x 11"	White	260	4	6 lbs.	Stock
10007003K^	1" x 7"	White	390	3	6 lbs.	Stock

^(1 x 7) QuickClip: Includes 3 wristband cartridges and 1,450 white clips. Color clips sold separately.

\*(1.1875 x 11) QuickClip: Includes 4 wristband cartridges and 1,160 white clips. Color clips sold separately.

Must be ordered in carton quantities. Each part number represents 1 carton.

#### Color Clips for Z-Band Quick Clip

PartNumber	Color	Quantity Per Pack	Stock MTO
97032-Pink	Pink	275	Stock
97032-Red	Red	275	Stock
97032-Blue	Blue	275	Stock
97032-Green	Green	275	Stock
97032-Yellow	Yellow	275	Stock
97032-Purple	Purple	275	Stock



SEE MORE.  
DO MORE.

# Wristbanding

## Z-Band UltraSoft

### Z-Band UltraSoft Wristbands

Ultra-soft and flexible direct thermal polypropylene and vinyl wristband with an adhesive tamper-evident tab for securement. Scannable up to 14 days.

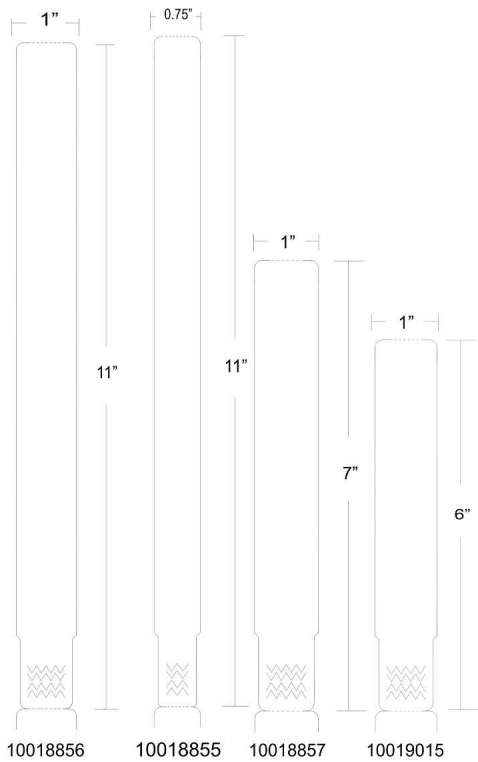

Size (inches)	PartNumber	ID	OD	Color	Quantity Per Roll	Rolls Per Carton	Carton Weight	Stock MTO
0.75" x 11"	10018855	1"	5"	White	175	6	6 lbs.	Stock
1" x 11"	10018856	1"	5"	White	175	6	6 lbs.	Stock
1" x 7"	10018857	1"	5"	White	250	6	6 lbs.	Stock
1" x 6"	10019015	1"	5"	White	300	6	6 lbs.	Stock

Stock - ships within one business day, Made to order - ships within 6 business days.  
Prices effective January 2015 - All prices subject to change without notice.

Need a custom solution? Call for a quote today: +1 866 230 9495





SEE MORE.  
DO MORE.

# Wristbanding

## Z-Band Direct

### Z-Band Direct Wristbands

Direct thermal polypropylene wristband with an adhesive tamper-evident tab for securement. Scannable up to 14 days.

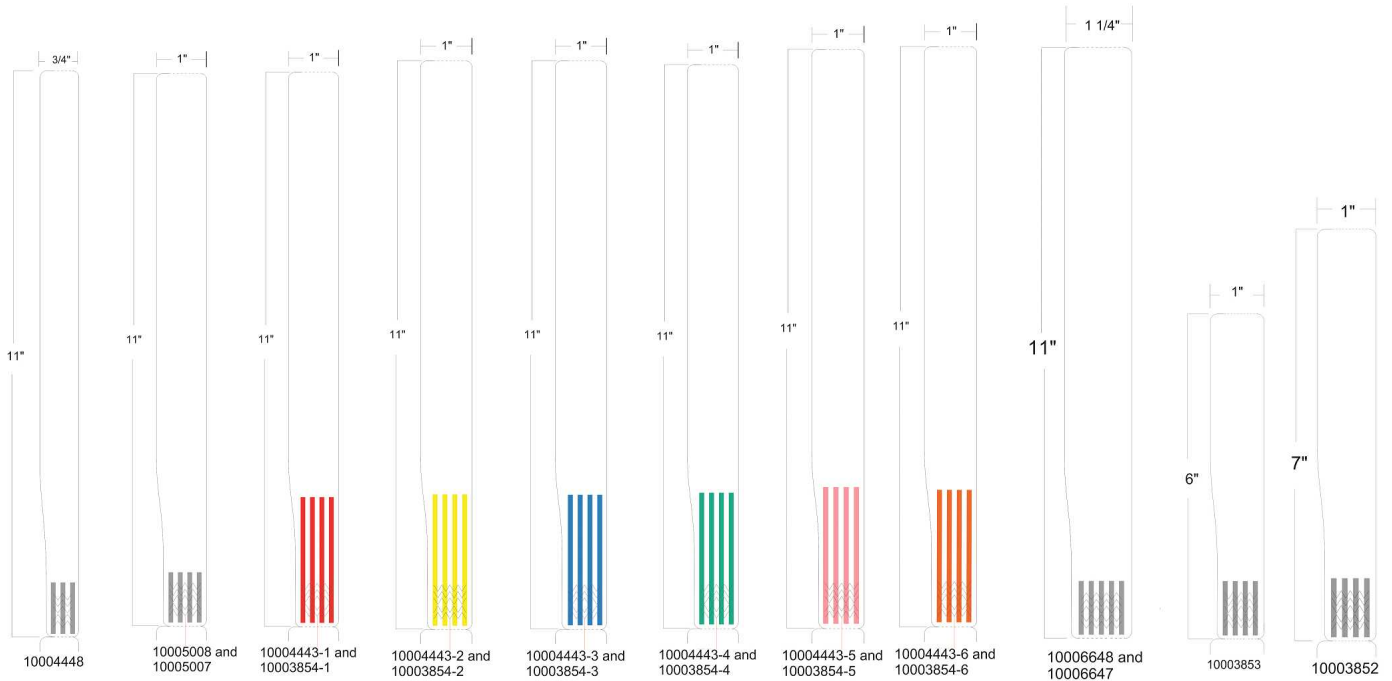

Size (inches)	PartNumber	ID	OD	Color	Quantity Per Roll	Rolls Per Carton	Carton Weight	Stock MTO
0.75" x 11"	10004448	1"	5"	White	200	6	4.8 lbs.	Stock
1" x 11"	10005008	1"	5"	White	200	6	4.8 lbs.	Stock
1" x 11"	10005007	3"	8"	White	450	6	9 lbs.	Stock
1" x 11"	10004443-1	1"	5"	Red	200	6	4.8 lbs.	Stock
1" x 11"	10003854-1	3"	8"	Red	450	6	9 lbs.	MTO
1" x 11"	10004443-2	1"	5"	Yellow	200	6	4.8 lbs.	Stock
1" x 11"	10003854-2	3"	8"	Yellow	450	6	9 lbs.	MTO
1" x 11"	10004443-3	1"	5"	Blue	200	6	4.8 lbs.	Stock
1" x 11"	10003854-3	3"	8"	Blue	450	6	9 lbs.	MTO
1" x 11"	10004443-4	1"	5"	Green	200	6	4.8 lbs.	Stock
1" x 11"	10003854-4	3"	8"	Green	450	6	9 lbs.	MTO
1" x 11"	10004443-5	1"	5"	Pink	200	6	4.8 lbs.	Stock
1" x 11"	10003854-5	3"	8"	Pink	450	6	9 lbs.	MTO
1" x 11"	10004443-6	1"	5"	Orange	200	6	4.8 lbs.	Stock
1" x 11"	10003854-6	3"	8"	Orange	450	6	9 lbs.	MTO
1.25" x 11"	10006647	1"	5"	White	200	6	4.8 lbs.	Stock
1.25" x 11"	10006648	3"	8"	White	450	6	9 lbs.	Stock
1" x 6"	10003853	1"	5"	White	350	6	4.8 lbs.	Stock
1" x 7"	10003852	1"	5"	White	300	6	4.8 lbs.	Stock

Stock - ships within one business day, Made to order - ships within 6 business days.  
Prices effective January 2015 - All prices subject to change without notice.

Need a custom solution? Call for a quote today: +1 866 230 9495



SEE MORE.  
DO MORE.

# Wristbanding

## Z-Band Fusion

### Z-Band Fusion Wristbands: 3" ID, 8" OD

Self-laminating direct thermal polypropylene wristband with an adhesive closure and a wristband extender to fit a wide range of wrist sizes. Scannable up to 60 days.

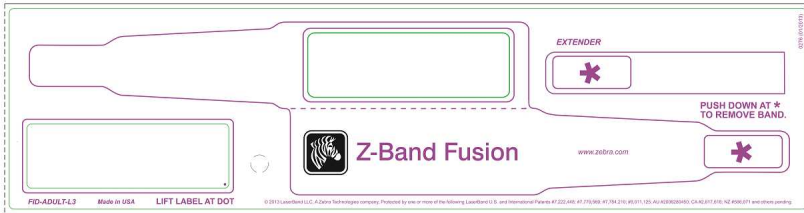

FID-ADULT-L3-3-500T

Image Area W x L	PartNumber	Wristband Length	Sheet Width	Color	Bands Per Roll	Rolls/Case	Case Weight	Stock MTO
2.75" x 0.875"	FID-ADULT-L3-3-500T	9.25"	3"	White	500	2	7 lbs.	Stock

All Z-Band Fusion part numbers are perforated.

Stock - ships within one business day, Made to order - ships within 6 business days.  
Prices effective January 2015 - All prices subject to change without notice.

Need a custom solution? Call for a quote today: +1 866 230 9495



SEE MORE.  
DO MORE.

# Wristbanding

## Z-Band Fusion

### Z-Band Fusion Wristbands: 1" ID, 5" OD

Self-laminating direct thermal polypropylene wristband with an adhesive closure and a wristband extender to fit a wide range of wrist sizes. Scannable up to 60 days.

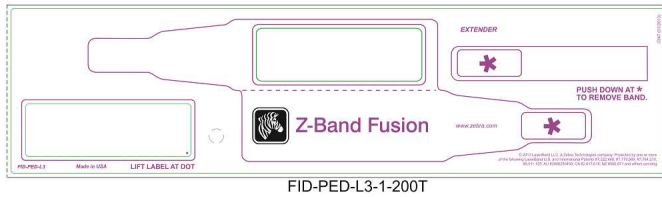
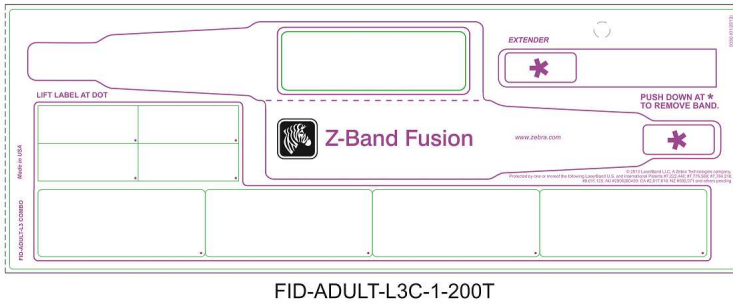
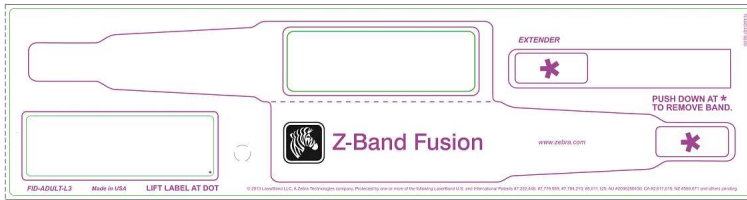

Image Area W x L	PartNumber	Wristband Length	Sheet Width	Color	Bands Per Roll	Rolls/Case	Case Weight	Stock MTO
2.75" x 0.875"	FID-ADULT-L3-1-200T	9.25"	3"	White	200	5	7 lbs.	Stock
2.75" x 0.875"	FID-ADULT-L3C-1-200T	9.25"	4"	White	200	5	10 lbs.	Stock
2.75" x 0.875"	FID-PED-L3-1-200T	7.375"	3"	White	200	5	8 lbs.	Stock
1.63" x 0.750"	FID-BABY-L3-1-200T	5.75"	3"	White	200	5	8 lbs.	Stock

All Z-Band Fusion part numbers are perforated.

Stock - ships within one business day, Made to order - ships within 6 business days.  
Prices effective January 2015 - All prices subject to change without notice.

Need a custom solution? Call for a quote today: +1 866 230 9495



SEE MORE.  
DO MORE.

# Wristbanding

## Z-Band Fusion

### Z-Band Fusion Infant ID Tags

Self-laminating direct thermal polypropylene infant tags, perfect for use in the NICU where the average infant stay exceeds 14 days. Can be used in conjunction with the ComfyCuff foam wristband, SwaddleBand and Vinyl Infant Wristband Solution. Latex-free.



FID-BABY-T-1-500

FID-BABY-T-3-1M

Image Area W x L	PartNumber	ID/OD	Sheet Width	Color	Tags/Roll	Rolls/Case	Case Weight	Stock MTO
1.75" x 0.875"	FID-BABY-T-1-500	1" ID, 5" OD	2.50"	White	500	2	7 lbs.	Stock
1.75" x 0.875"	FID-BABY-T-3-1M	3" ID, 8" OD	2.50"	White	1,000	1	7 lbs.	Stock

All Z-Band Fusion part numbers are perforated.

*Stock - ships within one business day, Made to order - ships within 6 business days.  
Prices effective January 2015 - All prices subject to change without notice.*

Need a custom solution? Call for a quote today: +1 866 230 9495



SEE MORE.  
DO MORE.

# Wristbanding

## Quick Clip

### Z-Band Quick Clip Kit

Direct thermal polypropylene wristband with secure clip closures. Scannable up to 14 days.

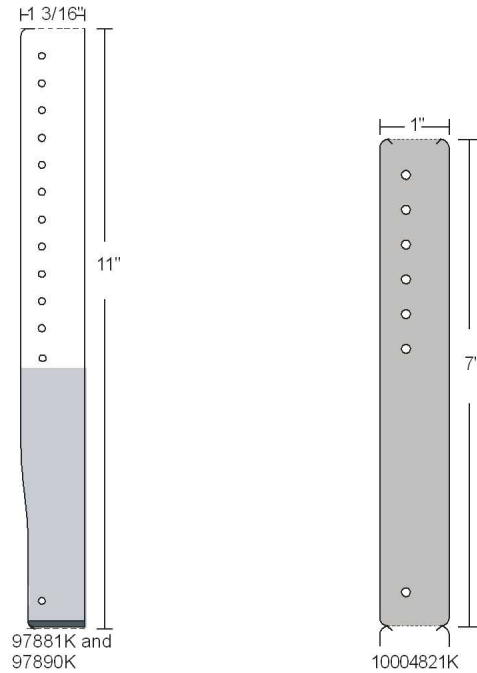

Size (inches)	PartNumber	ID	OD	Quantity Per Roll	Rolls Per Carton	Carton Weight	Stock MTO
1" x 7"	10004821K <sup>^</sup>	1"	5"	390	6	10 lbs.	Stock
1.1875" x 11"	97881K <sup>*</sup>	1"	5"	260	6	11 lbs.	Stock
1.1875" x 11"	97890K <sup>**</sup>	3"	8"	550	6	11 lbs.	Stock

<sup>^</sup> (1 x 7) Includes 6 rolls of perforated wristbands and 2,610 white clips. Color clips sold separately.  
<sup>\*</sup> (1.1875 x 11) Includes 6 rolls of perforated wristbands and 1,740 white clips. Color clips sold separately.  
<sup>\*\*</sup> (1.1875 x 11) Includes 6 rolls of perforated wristbands and 3,480 white clips. Color clips sold separately.

### Color Clips for Z-Band Quick Clip Wristbands

PartNumber	Color	Quantity Per Pack	Stock MTO
97032-Pink	Pink	275	Stock
97032-Red	Red	275	Stock
97032-Blue	Blue	275	Stock
97032-Green	Green	275	Stock
97032-Yellow	Yellow	275	Stock
97032-Purple	Purple	275	Stock

Stock - ships within one business day, Made to order - ships within 6 business days.  
 Prices effective January 2015 - All prices subject to change without notice.

Need a custom solution? Call for a quote today: +1 866 230 9495



SEE MORE.  
DO MORE.

# Wristbanding

## Infant

### Soft Infant Wristband

A direct thermal white polypropylene wristband with soft nylon lining with a t-shaped adjustable design, flat surface print area and an adhesive tab for securement .

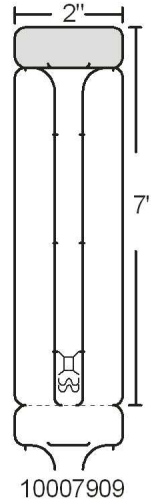

Size (inches)	PartNumber	Quantity Per Roll	Rolls Per Carton	Carton Weight	Stock MTO
2" x 7"	10007909	275	6	6 lbs.	Stock

Stock - ships within one business day, Made to order - ships within 6 business days.  
Prices effective January 2015 - All prices subject to change without notice.

Need a custom solution? Call for a quote today: +1 866 230 9495





SEE MORE.  
DO MORE.

# Wristbanding - Non-Printable

## Alert Solutions

### Spot Alert Labels

Spot-alert color-coded labels can be adhered to any Zebra wristband and feature a strong tamper-evident adhesive that causes the label to tear if tampered with. Available in standard color and designation combinations to support the most critical patient conditions.

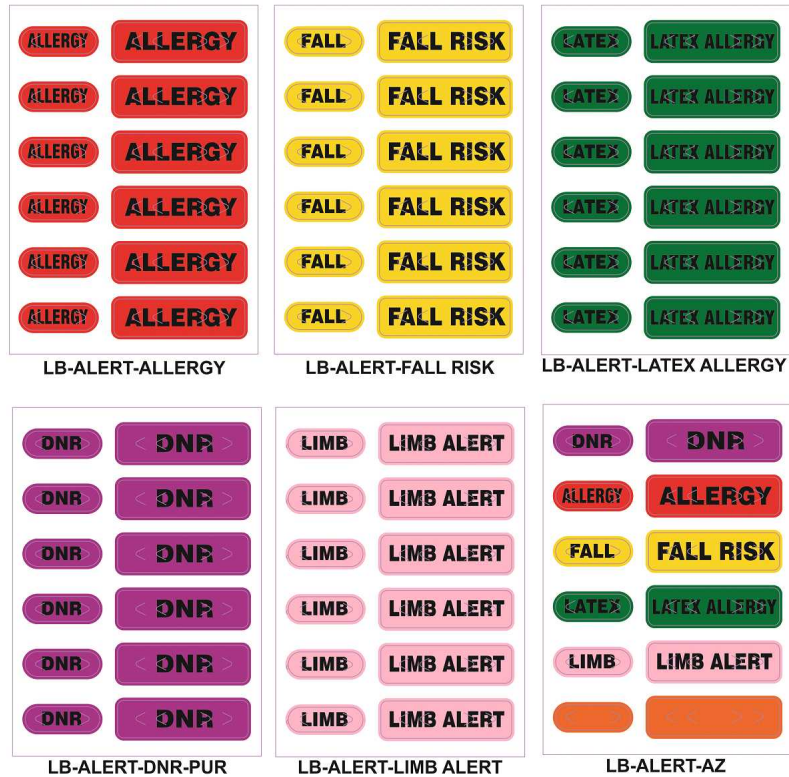

Sheet Size W x L (inches)	PartNumber	Alert Designation	Color	Labels/Form	Forms/Case	Case Weight	Stock MTO
2.5" x 3.5"	LB-ALERT-ALLERGY	Allergy	Red	12	1,000	3 lbs.	Stock
2.5" x 3.5"	LB-ALERT-FALLRISK	Fall Risk	Yellow	12	1,000	3 lbs.	Stock
2.5" x 3.5"	LB-ALERT-DNR-PUR	DNR	Purple	12	1,000	3 lbs.	Stock
2.5" x 3.5"	LB-ALERT-LATEXALLERGY	Latex Allergy	Green	12	1,000	3 lbs.	Stock
2.5" x 3.5"	LB-ALERT-LIMBALERT	Limb Alert	Pink	12	1,000	3 lbs.	Stock
2.5" x 3.5"	LB-ALERT-AZ	All	All	12	1,000	3 lbs.	Stock

Each sheet contains (6) labels sized 1.3125" x 0.375" and (6) labels sized 0.75" x 0.25".

Stock - ships within one business day, Made to order - ships within 6 business days.  
Prices effective January 2015 - All prices subject to change without notice.

Need a custom solution? Call for a quote today: +1 866 230 9495





SEE MORE.  
DO MORE.

# Wristbanding - Non-Printable

## Alert Solutions

### Slim Alert Wristbands

Pre-printed vinyl alert wristbands with an integrated clip closure. Available in standard color and designation combinations to support the most critical patient conditions.

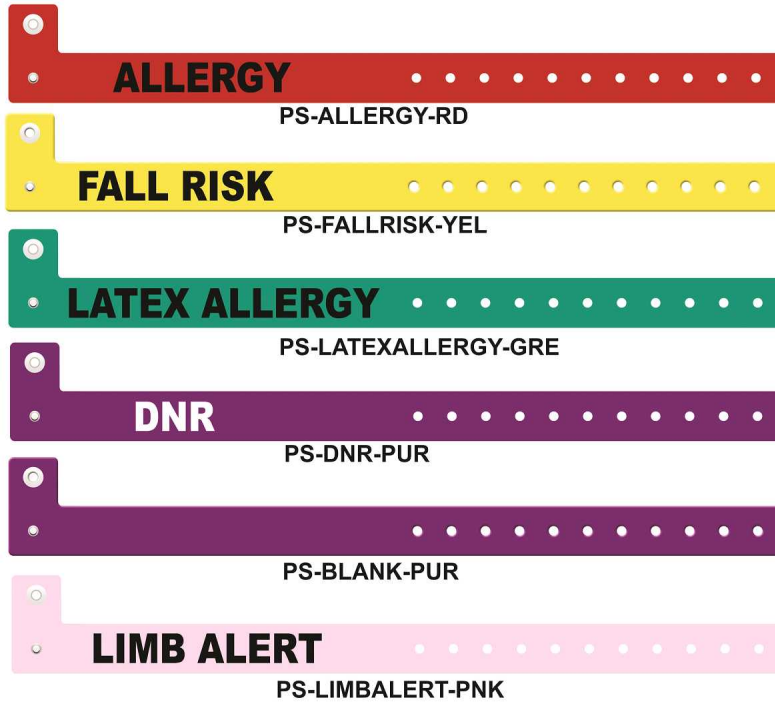

Size W x L (inches)	PartNumber	Alert Designation	Color	Bands/Case	Case Weight	Stock MTO
0.625" x 10"	PS-ALLERGY-RED	Allergy	Red	500	3 lbs.	Stock
0.625" x 10"	PS-FALLRISK-YEL	Fall Risk	Yellow	500	3 lbs.	Stock
0.625" x 10"	PS-DNR-PUR	DNR	Purple	500	3 lbs.	Stock
0.625" x 10"	PS-LATEXALLERGY-GRE	Latex Allergy	Green	500	3 lbs.	Stock
0.625" x 10"	PS-LIMBALERT-PNK	Limb Alert	Pink	500	3 lbs.	Stock
0.625" x 10"	PS-BLANK-PUR	Blank	Purple	500	3 lbs.	Stock

Stock - ships within one business day, Made to order - ships within 6 business days.  
Prices effective January 2015 - All prices subject to change without notice.

Need a custom solution? Call for a quote today: +1 866 230 9495



SEE MORE.  
DO MORE.

# Wristbanding - Non-Printable

## Alert Solutions

### Tyvek Alert Wristbands

Color-coded Tyvek® alert wristbands with a tamper-evident adhesive closure. Available in standard color and designation combinations to support the most critical patient conditions.



Size W x L (inches)	PartNumber	Alert Designation	Color	Bands/Case	Case Weight	Stock MTO
0.625" x 10"	TY-ALLERGY	Allergy	Red	1,000	2 lbs.	Stock
0.625" x 10"	TY-FALLRISK	Fall Risk	Yellow	1,000	2 lbs.	Stock
0.625" x 10"	TY-DNR-PUR	DNR	Purple	1,000	2 lbs.	Stock
0.625" x 10"	TY-LATEXALLERGY	Latex Allergy	Green	1,000	2 lbs.	Stock
0.625" x 10"	TY-LIMBALERT	Limb Alert	Pink	1,000	2 lbs.	Stock
0.625" x 10"	TY-ISOLATION	Isolation	Green	1,000	2 lbs.	Stock
0.625" x 10"	TY-NOSTICKNOBP	No Needles, No Blood Pressure	Pink	1,000	2 lbs.	Stock
0.625" x 10"	TY-OSARISK	Obstructive Sleep Apnea	Blue	1,000	2 lbs.	Stock
0.625" x 10"	TY-BLANK-SIL	Blank	Silver	1,000	2 lbs.	Stock

Stock - ships within one business day, Made to order - ships within 6 business days.  
Prices effective January 2015 - All prices subject to change without notice.

Need a custom solution? Call for a quote today: +1 866 230 9495



SEE MORE.  
DO MORE.

# Wristbanding - Non-Printable

## OmniBand

### OmniBand

Self-laminating wristband with a tamper evident adhesive closure that can be used in conjunction with virtually any printed label. Includes wristband extender to fit a wide variety of wrist sizes.

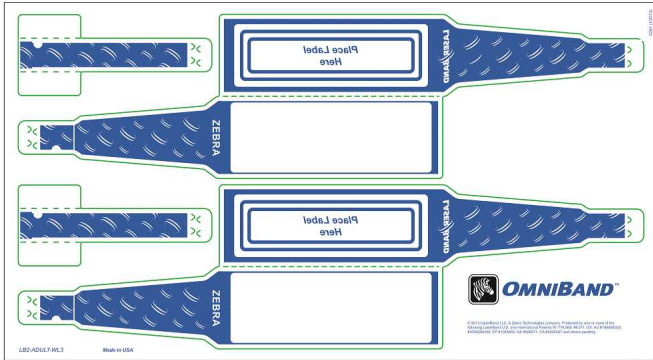

**LB2-ADULT-WL3**  
Available in white, red, blue and orange

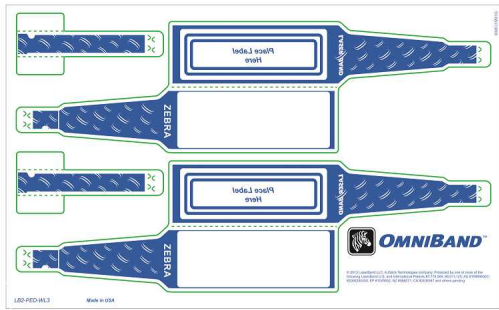

**LB2-PED-WL3**  
Available in white

Max Label Size W x L (inches)	PartNumber	Wristband Length	Extender Length	Color	Bands/Case	Case Weight	Stock MTO
3.25" x 1.00"	LB2-ADULT-WL3	10"	3.25"	White	1,000	10 lbs.	Stock
3.25" x 1.00"	LB2-ADULT-WL3-RED	10"	3.25"	Red	1,000	10 lbs.	MTO
3.25" x 1.00"	LB2-ADULT-WL3-BLU	10"	3.25"	Blue	1,000	10 lbs.	Stock
3.25" x 1.00"	LB2-ADULT-WL3-ORA	10"	3.25"	Orange	1,000	10 lbs.	Stock
2.25" x 0.75"	LB2-PED-WL3	8"	2.625"	White	1,000	7 lbs.	Stock

Sheet measures 4.25" x 11".  
500 sheets/case containing (2) wristbands and (2) extenders each.

Stock - ships within one business day, Made to order - ships within 6 business days.  
Prices effective January 2015 - All prices subject to change without notice.

Need a custom solution? Call for a quote today: +1 866 230 9495



SEE MORE.  
DO MORE.

## Wristbanding - Non-Printable

### Vinyl Infant Wristband Solutions

#### Vinyl Infant Wristband Solutions

Soft, flexible vinyl wristbands for use with Z-Band Fusion Infant ID Tags. The narrow width allows some models of "Abduction Prevention Systems" to be attached. Available in clip or self-locking closure. Self-locking closure can be adjusted with a gentle tug as the infant loses mass around the wrists and ankles within the first 24 hours of birth. Latex-free.

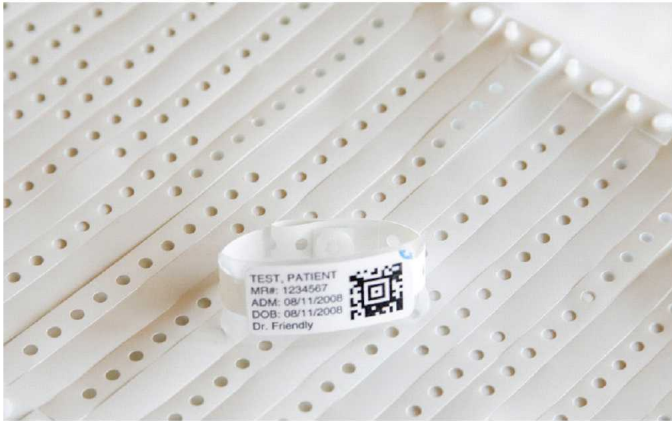

PS-BABY



PS-INFANT-ADJ

\* PS-BABY and PS-INFANT-ADJ are pictured with Z-Band Fusion Infant ID Tags.

Size W x L (inches)	PartNumber	Closure Style	Color	Bands/Case	Case Weight	Stock MTO
0.39" x 6.25"	PS-BABY	Clip	White	250	1 lb.	Stock
0.39" x 8.5"	PS-INFANT-ADJ	Self-locking	White	250	1 lb.	Stock

Stock - ships within one business day, Made to order - ships within 6 business days.  
Prices effective January 2015 - All prices subject to change without notice.

Need a custom solution? Call for a quote today: +1 866 230 9495



SEE MORE.  
DO MORE.

## Wristbanding - Non-Printable

### ComfyCuff Solution

#### ComfyCuff

Soft foam cuff featuring an adjustable Velcro® closure ensuring infant comfort. Can be used in conjunction with Z-Band Fusion Infant ID Tags, ComfyCuff Infant SwaddleBand and ComfyCuff Security Seal.



LB2-BABY-P

\*Pictured with Z-Band Fusion Infant ID Tag

Size W x L (inches)	PartNumber	Color	Bands/Case	Case Weight	Stock MTO
1.375" x 5.5"	LB2-BABY-P	White	100	1 lb.	Stock

#### ComfyCuff Security Seal

Label designed to securely stick to the ComfyCuff material and self-destruct to indicate wristband tampering. Latex-free.



LB2-BABY-CCS

\*Pictured with LB2-BABY-P (ComfyCuff) and Z-Band Fusion Infant ID Tag

Size W x L (inches)	PartNumber	Color	Bands/Case	Case Weight	Stock MTO
2.875" x 0.4375"	LB2-BABY-CCS	White	1,000	1 lb.	Stock





SEE MORE.  
DO MORE.

# Wristbanding - Non-Printable

## ComfyCuff Solution

### ComfyCuff Infant Swaddle Band

Soft Tyvek® band that makes identifying a swaddled infant quick and easy. Creates an extension between the ComfyCuff and Z-Band Fusion Infant ID Tags or wristband, allowing the tag to be easily accessible. Latex-free.



LB2-BABY-SWB9

\*Pictured with ComfyCuff and Z-Band Fusion Infant ID Tags

Size W x L (inches)	PartNumber	Color	Bands/Case	Case Weight	Stock MTO
0.41" x 9"	LB2-BABY-SWB9	White	500	1 lb.	Stock

Stock - ships within one business day, Made to order - ships within 6 business days.  
Prices effective January 2015 - All prices subject to change without notice.

Need a custom solution? Call for a quote today: +1 866 230 9495



SEE MORE.  
DO MORE.

# Ribbons

Ribbon Part #	Width (inches)	Width (mm)	Length (feet)	Length (m)	Quantity Per Carton	Weight	Stock MTO	Printer Type
---------------	-------------------	---------------	------------------	---------------	------------------------	--------	--------------	-----------------

## 6100 WAX/RESIN

6100GS06407	2.52"	64mm	244'	74m	48	3 lbs.	Stock	Desktop
06100BK06045	2.36"	60mm	1,476'	450m	6	5 lbs.	Stock	Tabletop
06100BK08045	3.15"	80mm	1,476'	450m	6	6 lbs.	Stock	Tabletop
06100BK11045	4.33"	110mm	1,476'	450m	6	7 lbs.	Stock	Tabletop

## 5555 WAX/RESIN

05555BK110D	4.33"	110mm	98'	98'	10	2 lbs.	Stock	Mobile
-------------	-------	-------	-----	-----	----	--------	-------	--------

## 6200 RESIN

06200BK06045	2.36"	60mm	1,476'	450m	6	5 lbs.	Stock	Tabletop
06200BK08345	3.27"	83mm	1,476'	450m	6	6 lbs.	Stock	Tabletop

## IMAGE LOCK

74941	2.50"	110mm	244'	74m	12	8 lbs.	MTO	Desktop
74943	4.30"	110mm	244'	74m	12	12 lbs.	MTO	Desktop

**MINIMUM ORDER QUANTITY FOR ALL RIBBONS IS 1 CARTON.**

*Stock - ships within one business day, Made to order - ships within 6 business days.  
Prices effective January 2015 - All prices subject to change without notice.*

Need a custom solution? Call for a quote today: **+1 866 230 9495**



[www.L-TronDirect.com](http://www.L-TronDirect.com)

800-830-9523

[info@L-Tron.com](mailto:info@L-Tron.com)

596 Fishers Station Dr | Victor, NY | 14564 | Suite 1 A

[www.L-Tron.com](http://www.L-Tron.com)

Get in touch with us  
on social media!

