



Leading Media Products

Multi-Purpose Media



Multi-Purpose Labeling

North America



CONTENTS

MEDIA FOR DESKTOP PRINTERS

- Duratherm II Labels.....3
- Duratherm III Labels.....4
- Duratron II Labels.....5
- Duratron S Film Labels.....6
- Duratron II Gloss Polyester Labels7
- ThermaMAX 1000 Wax Ribbons.....8
- ThermaMAX 2000 Mid-Range Ribbons8
- ThermaMAX 3000 Resin Ribbons8

MEDIA FOR INDUSTRIAL PRINTERS

- Duratherm II Labels.....9
- Duratherm II Tag10
- Duratherm III Labels.....11
- Duratron II Labels.....12
- Duratron II Floodcoated Labels.....13
- Duratron II Tags14
- Duratron II Kimdura Film Labels15
- Duratron II Valeron Film Tags.....16
- Duratron II Gloss Polyester Labels16
- ThermaMAX 1000 Wax Ribbons.....17
- ThermaMAX 2000 Mid-Range Ribbons17
- ThermaMAX 3000 Resin Ribbons17

APPENDIX

- Direct Thermal vs. Thermal Transfer18
- Free Printhead Replacement Program18

MEDIA FOR DESKTOP PRINTERS

Duratherm II Labels

Duratherm II is a non top-coated direct thermal paper that offers high quality, cost-effective printing. This material is recommended for most general-use applications where exposure to chemicals and moisture is not anticipated. Permanent adhesive.

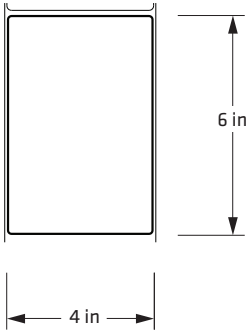

E25726

Size	ID	OD	Part Number	Qty/Roll	Rolls/Ctn	Ctn Weight	Stock/MTO
4" x 6"	1.5"	5"	E25726	439	8	17	Stock



MEDIA FOR DESKTOP PRINTERS

Duratherm III Labels

Duratherm III is a top-coated direct thermal paper that provides enhanced durability for applications where humidity and surface abrasion are a concern. Permanent adhesive.

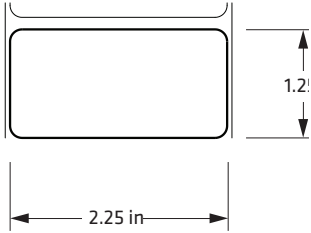

E15532

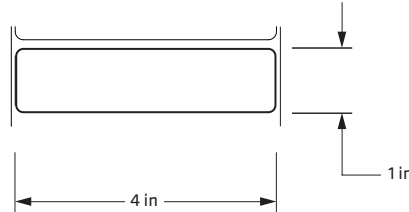

E15534

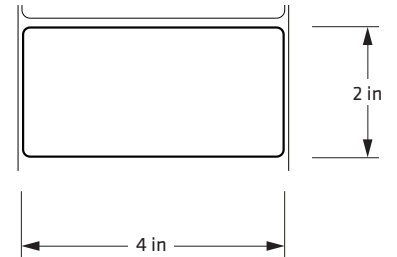

E15535

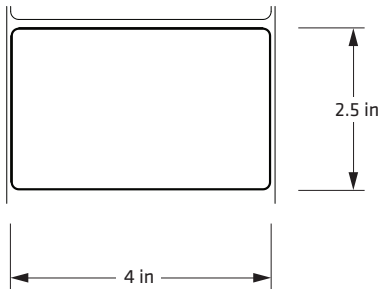

E15536

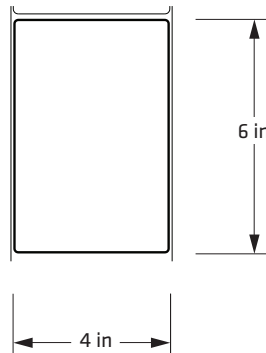

E15539

Size	ID	OD	Part Number	Qty/Roll	Rolls/Ctn	Ctn Weight	Stock/MTO
2.25" x 1.25"	1.5"	5"	E15532	1793	8	13	Stock
4" x 1"	1.5"	5"	E15534	2391	8	22	Stock
4" x 2"	1.5"	5"	E15535	1265	8	22	Stock
4" x 2.5"	1.5"	5"	E15536	1024	8	22	Stock
4" x 6"	1.5"	5"	E15539	439	8	22	Stock



MEDIA FOR DESKTOP PRINTERS

Duratran II Labels

Duratran™ II is a top-coated thermal transfer paper that demonstrates excellent print quality with the TMX1407 ribbon. This product is recommended where moderate abrasion, heat or sunlight are present. Permanent adhesive.

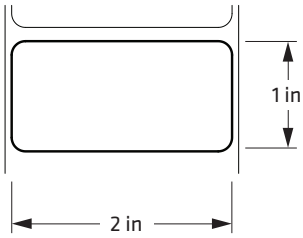

E25751

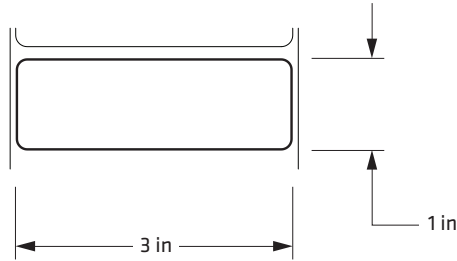

E17012

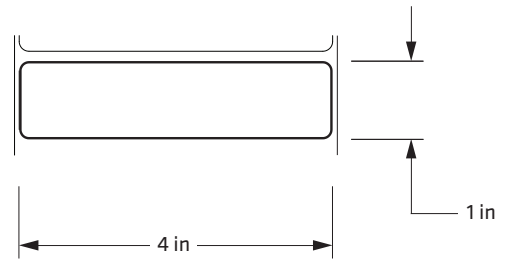

E15522

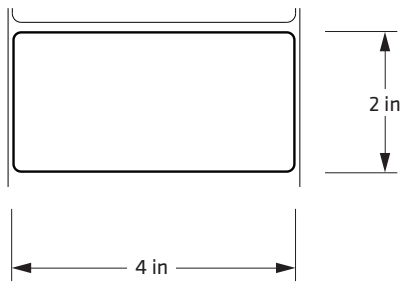

E15523

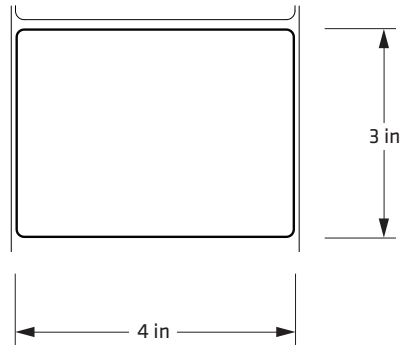

E25752

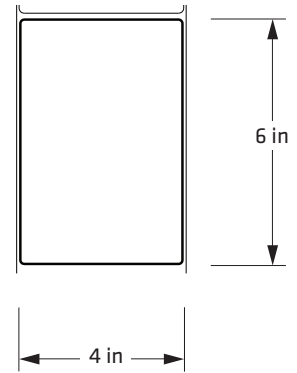

E15527

Size	ID	OD	Part Number	Qty/Roll	Rolls/Ctn	Ctn Weight	Stock/ MTO	PF8 Ribbon (½" Core)	PF8 Ribbon (1" Core)
2" x 1"	1.5"	5"	E25751	2,391	8	11	MTO	11043304	11232211
3" x 1"	1.5"	5"	E17012	2,391	8	17	Stock	11043304	11233011
4" x 1"	1.5"	5"	E15522	2,391	8	21	Stock	11044304	11234012
4" x 2"	1.5"	5"	E15523	1,265	8	21	Stock	11044304	11234012
4" x 3"	1.5"	5"	E25752	860	8	21	MTO	11044304	11234012
4" x 6"	1.5"	5"	E15527	439	8	21	Stock	11044304	11234012

MEDIA FOR DESKTOP PRINTERS

Duratran S Film Labels

A 3 mil thick polypropylene thermal transfer label at an attractive price point. The matte face stock offers excellent print quality and moisture resistance; recommended for up to 6 months outdoor exposure. Demonstrates excellent print quality when printed with the TMX2202 Mid-Range ribbon. Permanent adhesive.

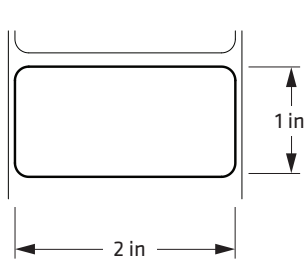

E25754

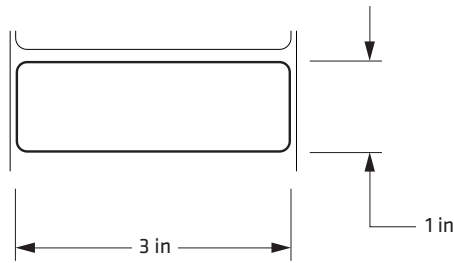

E25755

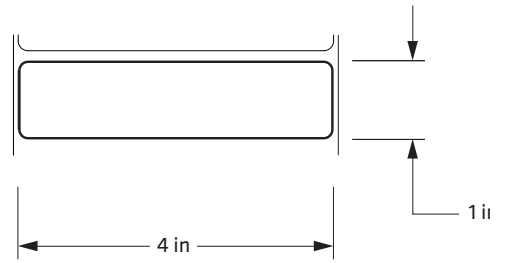

E25756

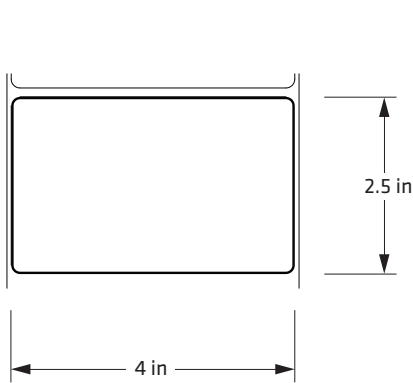

E25757

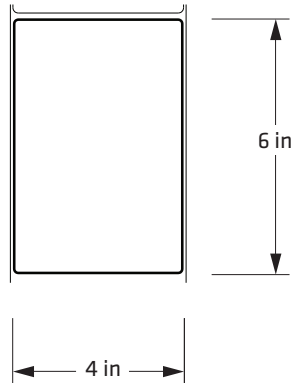

E25758

Size	ID	OD	Part Number	Qty/Roll	Rolls/Ctn	Ctn Weight	Stock/ MTO	PF8 Ribbon (½" Core)	PF8 Ribbon (1" Core)
2" x 1"	1.5"	5"	E25754	1,911	8	17	MTO	12042504	12232311
3" x 1"	1.5"	5"	E25755	1,911	8	17	MTO	12043204	12233111
4" x 1"	1.5"	5"	E25756	1,911	8	17	MTO	12044304	12234012
4" x 2.5"	1.5"	5"	E25757	819	8	17	MTO	12044304	12234012
4" x 6"	1.5"	5"	E25758	351	8	17	MTO	12044304	12234012

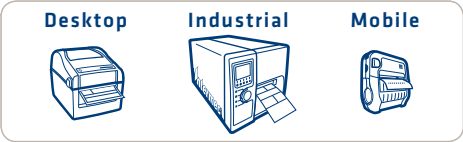

MEDIA FOR DESKTOP PRINTERS

Duratran II Gloss Polyester Labels

A high-gloss, top-coated polyester label with exceptional print quality. Excellent tear, smear and abrasion resistance; highly moisture and heat resistant. Product is UL recognized when printed with Intermec TMX3201 and TMX3202 ribbons. High-tack adhesive.

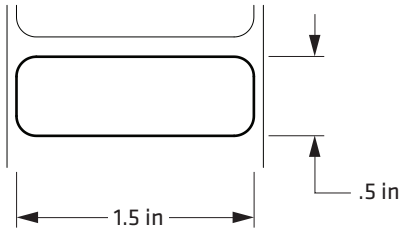

E25745

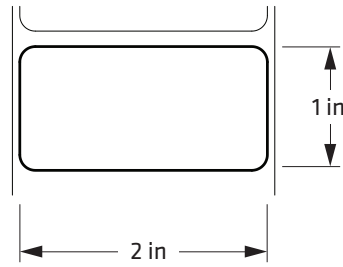

E22233

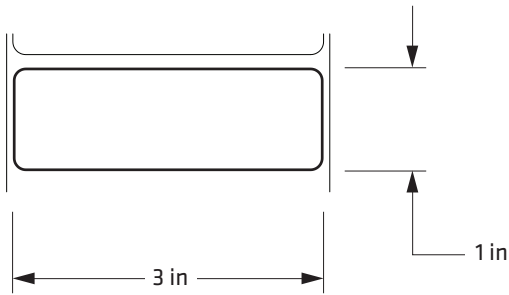

E25746

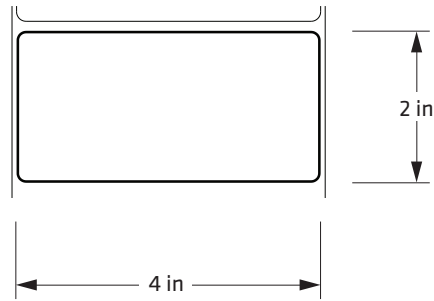

E25747

Size	ID	OD	Part Number	Qty/Roll	Rolls/Ctn	Ctn Weight	Stock/ MTO	PF8 Ribbon (1/2" Core)	PF8 Ribbon (1" Core)
1.5" x 0.5"	1.5"	5"	E25745	4,304	8	10	MTO	13042504	13632111
2" x 1"	1.5"	5"	E22233	2,391	8	12	Stock	13042504	13632111
3" x 1"	1.5"	5"	E25746	2,391	4	20	MTO	13044304	13634012
4" x 2"	1.5"	5"	E25747	1,265	4	26	MTO	13044304	13634012



MEDIA FOR DESKTOP PRINTERS

ThermaMAX 1000 Wax Ribbons

A general-purpose, smear-resistant wax ribbon providing good durability when printing on Duratran™ II Papers and Tags. Ribbons are wound coated side out.

Size	Length	Part Number	Qty/Ctn	Ctn Weight	Stock/MTO	Printer
2.35"	10800"	11232211	36	17	Stock	PD43t
3.1"	10800"	11233011	24	21	Stock	PD43t
3.27"	3588"	11043304	24	11	Stock	PD43t
4.1"	10800"	11234012	24	19	Stock	PD43t
4.33"	3588"	11044304	12	7	Stock	PD43t

ThermaMAX 2000 Mid-Range Ribbons

A mid-range ribbon that provides enhanced abrasion/smear resistance and high image quality when used with Duratran II coated papers and across the Intermec Mid-Range Film product line. Ribbons are wound coated side out.

Width	Length	Part Number	Qty/Ctn	Ctn Weight	Stock/MTO	Printer
2.35"	10800"	12232311	24	9	Stock	PD43t
2.5"	3588"	12042504	36	9	Stock	PD43t
3.15"	10800"	12233111	24	10	MTO	PD43t
3.27"	3588"	12043204	36	11	Stock	PD43t
4.1"	10800"	12234012	24	19	MTO	PD43t
4.33"	3588"	12044304	18	7	Stock	PC41, PF8 1/2" Core Ribbon

ThermaMAX 3000 Resin Ribbons

A high quality resin ribbon for applications that require the optimum level of smear and abrasion resistance. Excellent imaging and performance across the Intermec Ultra-Durable Film product line. Ribbons are wound coated side out. UL Recognized when used with Intermec Duratran II Gloss Polyester Labels.

Width	Length	Part Number	Qty/Ctn	Ctn Weight	Stock/MTO	Printer
2.36"	10800"	13632111	24	12	Stock	PD43t
2.5"	3588"	13042504	24	7	Stock	PD43t
3.1"	10800"	13633111	24	15	MTO	PD43t
3.1"	3588"	13633136	24	7	MTO	PD43t
4.1"	10800"	13634012	24	14	Stock	PD43t
4.33"	3588"	13044304	24	7	Stock	PD43t

Desktop



Industrial



Mobile



MEDIA FOR INDUSTRIAL PRINTERS

Duratherm II Labels

Duratherm II is a non top-coated direct thermal paper that offers high quality, cost-effective printing. This material is recommended for most general-use applications where exposure to chemicals and moisture is not anticipated. Permanent adhesive.

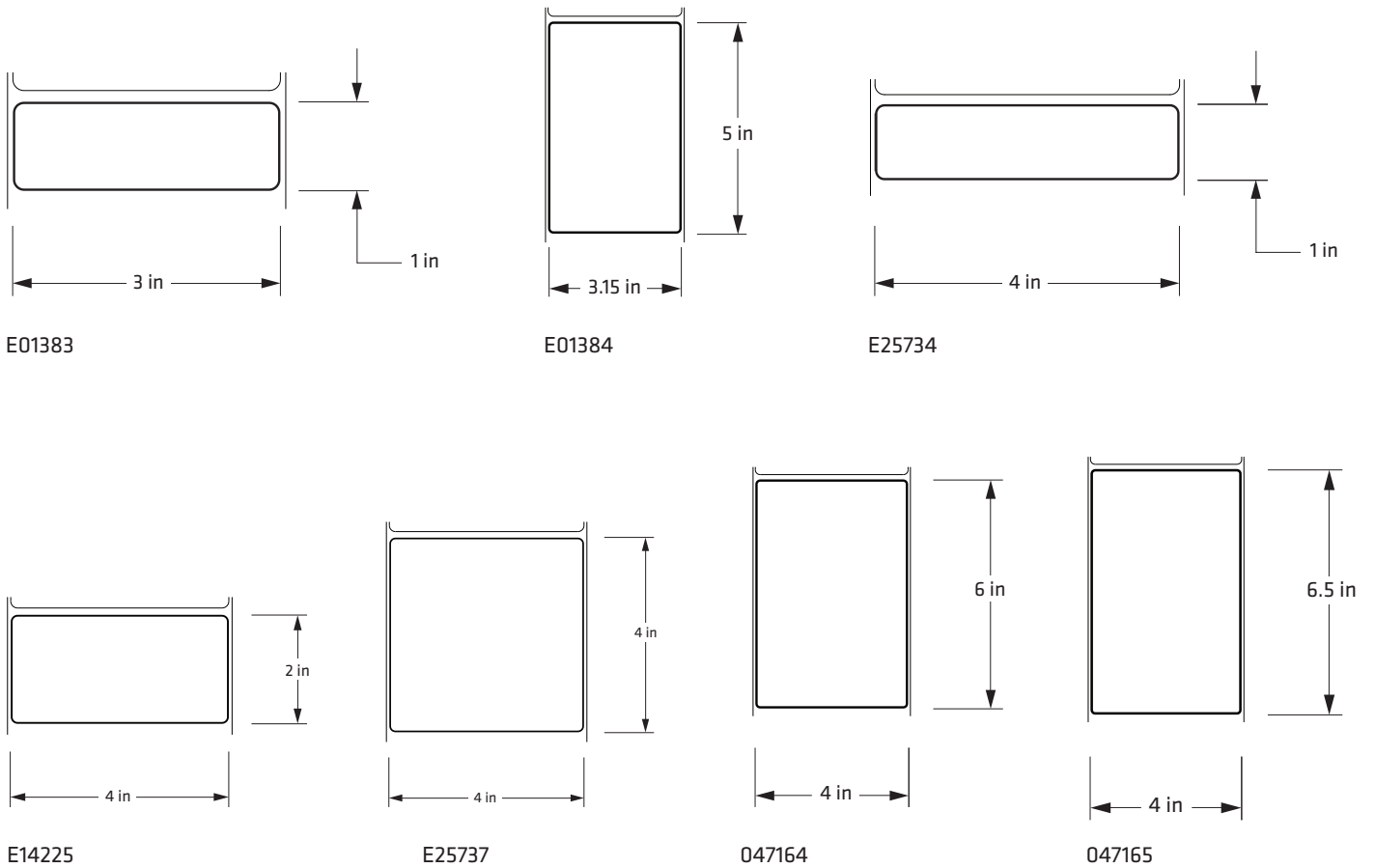

Size	ID	OD	Part Number	Qty/Roll	Rolls/Ctn	Ctn Weight	Stock/MTO
3" x 1"	3"	8.38"	E01383	5,333	4	18	Stock
3.15" x 5"	3"	8.38"	E01384	1,170	4	19	Stock
4" x 1"	3"	8.38"	E25734	5,333	4	25	MTO
4" x 2"	3"	8.38"	E14225	2,823	8	47	Stock
4" x 4"	3"	8.38"	E25737	1,454	4	25	MTO
4" x 6"	3"	8.38"	047164	979	4	24	Stock
4" x 6.5"	3"	8.38"	047165	905	4	24	Stock



MEDIA FOR INDUSTRIAL PRINTERS

Duratherm II Tag

Duratherm II Tag is a 7-mil non top-coated direct thermal paper that offers high quality, cost-effective printing. This material is recommended for most general-use applications where exposure to chemicals and moisture is not anticipated.

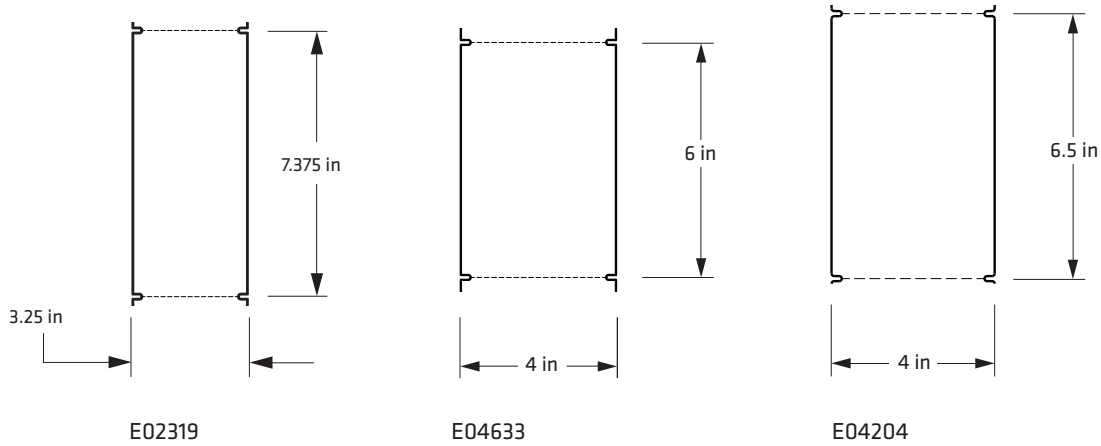

Size	ID	OD	Part Number	Qty/Roll	Rolls/Ctn	Ctn Weight	Stock/MTO
3.25" x 7.375"	3"	8.38"	E02319	813	4	20	Stock
4" x 6"	3"	8.38"	E04633	1,000	4	24	Stock
4" x 6.5"	3"	8.38"	E04204	923	8	24	Stock



MEDIA FOR INDUSTRIAL PRINTERS

Duratherm III Labels

Duratherm III is a top-coated direct thermal paper that provides enhanced durability for applications where humidity and surface abrasion are a concern. Permanent adhesive.

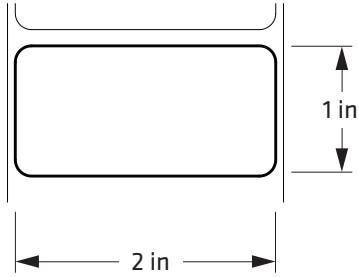

E22751

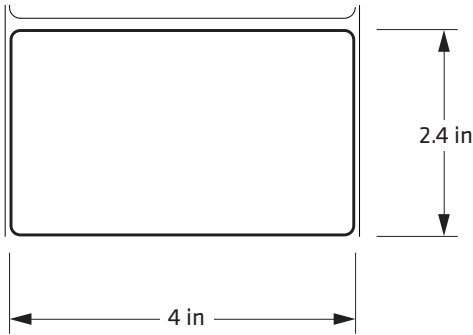

E06143

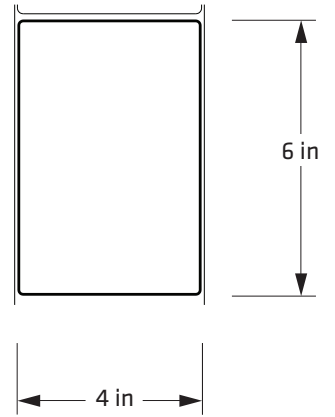

E06144

Width	ID	OD	Part Number	Qty/Roll	Rolls/Ctn	Ctn Weight	Stock/MTO
2" x 1"	3	8.38	E22751	4363	8	22	Stock
4" x 2.4"	3	8.38	E06143	2400	4	23	Stock
4" x 6"	3	8.38	E06144	979	4	23	Stock

MEDIA FOR INDUSTRIAL PRINTERS

Duratran II Labels

Duratran™ II is a top-coated thermal transfer paper that demonstrates excellent print quality with the TMX1407 ribbon. This product is recommended where moderate abrasion, heat or sunlight are present. Permanent adhesive.

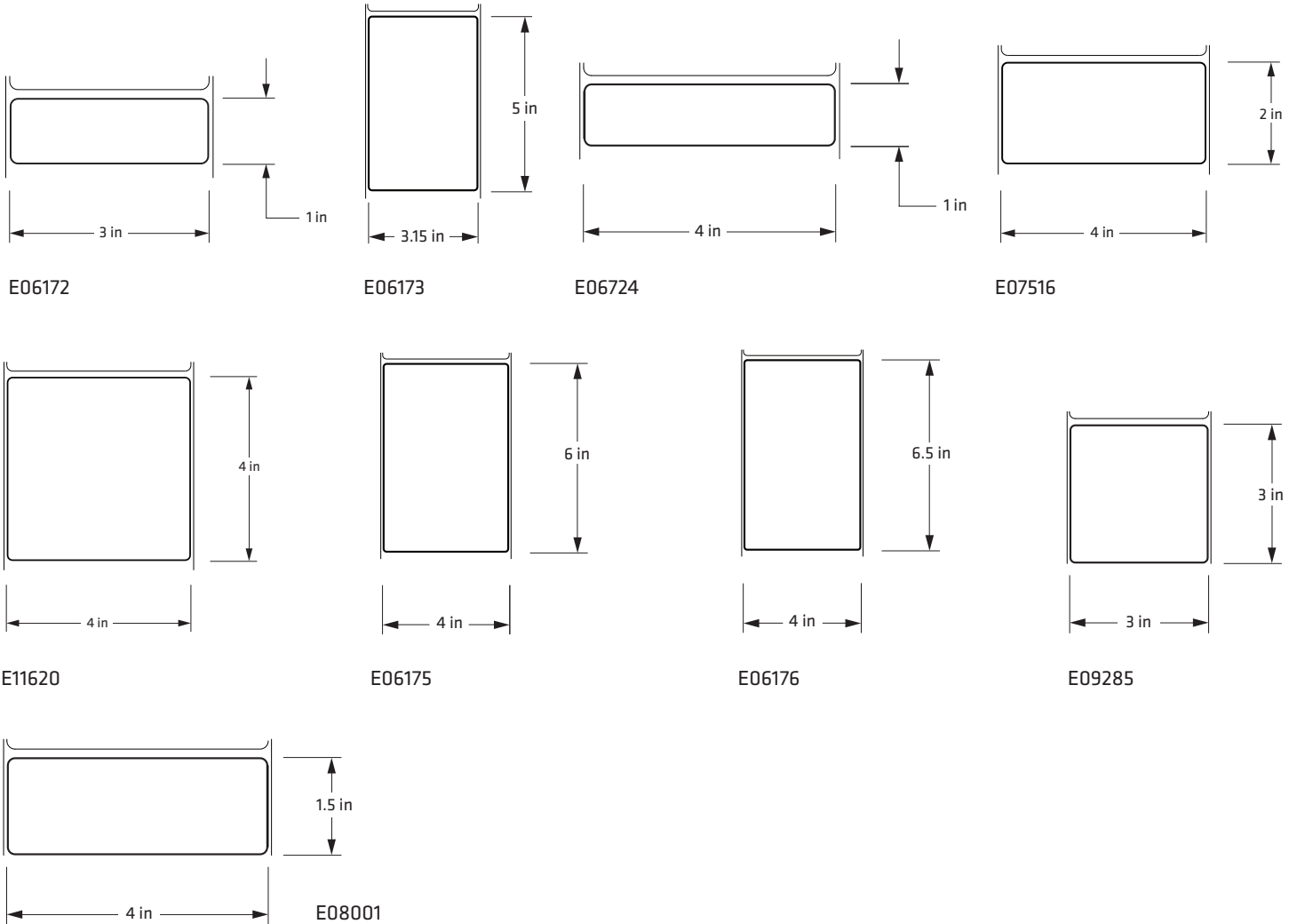

Size	ID	OD	Part Number	Qty/Roll	Rolls/Ctn	Ctn Weight	Stock/MTO	PD/PM/PX Ribbon
3" x 1"	3"	8.38"	E06172	5,333	4	20	Stock	11233018
3.15" x 5"	3"	8.38"	E06173	1,170	4	21	Stock	11234118
3" x 3"	3"	8.38"	E09285	1,920	4	20	Stock	11234118
4" x 1"	3"	8.38"	E06724	5,333	8	48	Stock	11234118
4" x 1.5"	3"	8.38"	E08001	3,692	4	24	Stock	11234118
4" x 2"	3"	8.38"	E07516	2,823	4	24	Stock	11234118
4" x 4"	3"	8.38"	E11620	1,454	4	25	Stock	11234118
4" x 6"	3"	8.38"	E06175	979	4	24	Stock	11234118
4" x 6.5"	3"	8.38"	E06176	905	4	24	Stock	11234118

MEDIA FOR INDUSTRIAL PRINTERS

Duratran II Floodcoated Labels

Duratran™ II Floodcoated Labels are pre-printed with a scanner-friendly solid color that demonstrates excellent print quality with the TMX1407 ribbon. This product is recommended where moderate abrasion, heat or sunlight are present. Permanent adhesive.

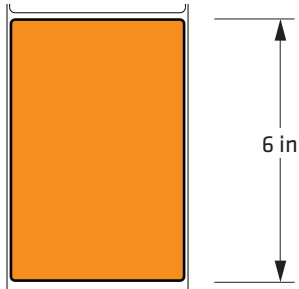

E07267-PMS021

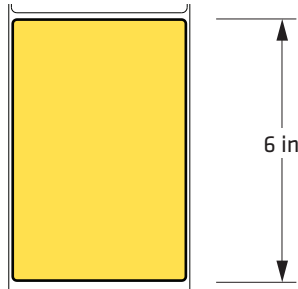

E07267-PMS115

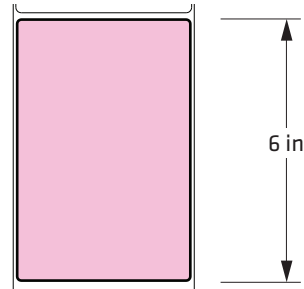

E07267-PMS236

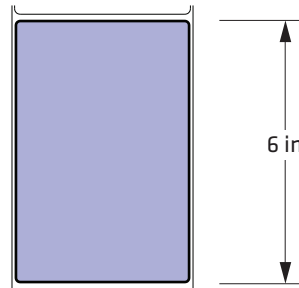

E07267-PMS2707

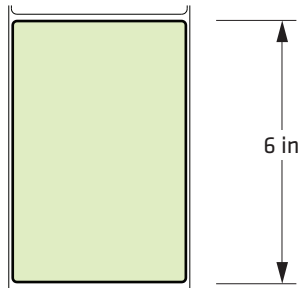

E07267-PMS365

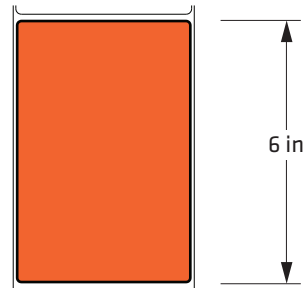

E07267-PMSWMRED

Size	ID	OD	Part Number	Qty/Roll	Rolls/Ctn	Ctn Weight	Stock/MTO	PD/PM/PX Ribbon
4" x 6"	3"	8.38"	E07267-PMS021	979	4	24	Stock	11234118
4" x 6"	3"	8.38"	E07267-PMS115	979	4	24	Stock	11234118
4" x 6"	3"	8.38"	E07267-PMS236	979	4	24	Stock	11234118
4" x 6"	3"	8.38"	E07267-PMS2707	979	4	24	Stock	11234118
4" x 6"	3"	8.38"	E07267-PMS365	979	4	24	Stock	11234118
4" x 6"	3"	8.38"	E07267-PMSWMRED	979	4	24	Stock	11234118



MEDIA FOR INDUSTRIAL PRINTERS

Duratran II Tags

Duratran II Tag is a 7-mil top-coated thermal transfer tag that demonstrates excellent print quality with the TMX1407 ribbon. This product is recommended where moderate abrasion, heat or sunlight are present.

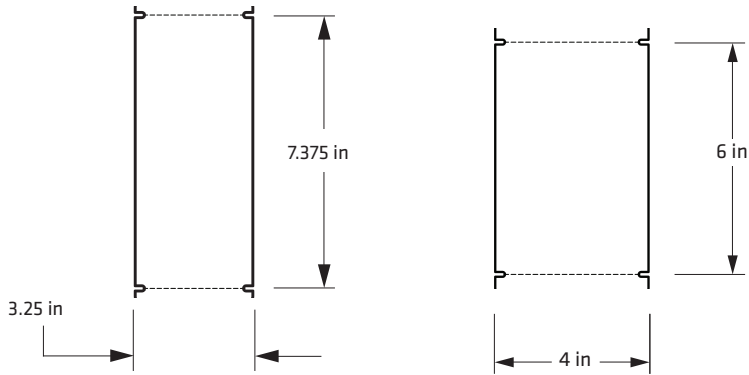

E04891

E09708

Size	ID	OD	Part Number	Qty/Roll	Rolls/Ctn	Ctn Weight	Stock/MTO	PD/PM/PX Ribbon
3.25" x 7.375"	3"	8.38"	E04891	813	8	41	Stock	11234118
4" x 6"	3"	8.38"	E09708	1,000	4	25	Stock	11234118

MEDIA FOR INDUSTRIAL PRINTERS

Duratran II Kimdura Film Labels

A durable, high-quality polyolefin thermal transfer label. Exhibits good tear resistance and moisture resistance, as well as moderate temperature and chemical resistance. Demonstrates excellent print quality when printed with the TMX2202 Mid-Range ribbon.

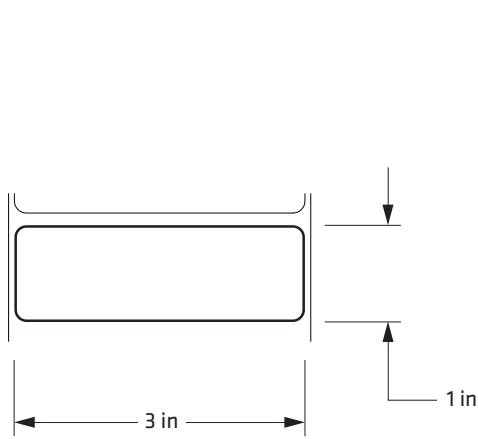

E02202

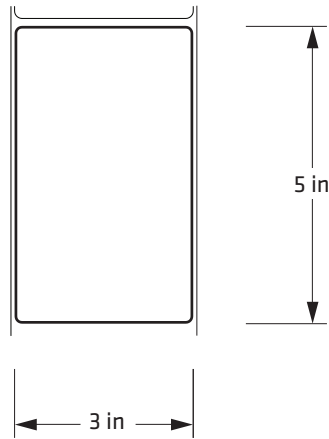

E02203

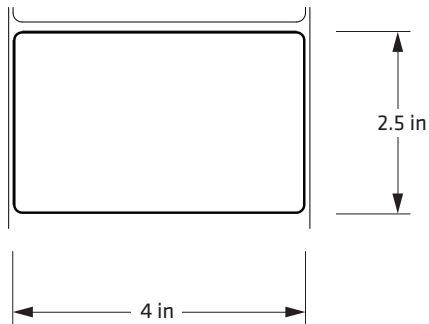

E02204

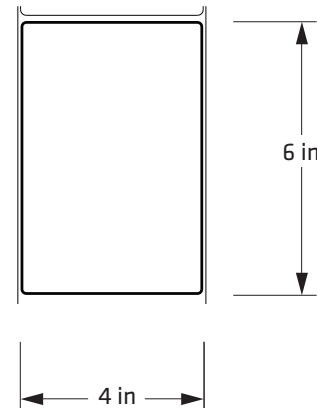

E03444

Size	ID	OD	Part Number	Qty/Roll	Rolls/Ctn	Ctn Weight	Stock/MTO	PD/PM/PX Ribbon
3" x 1"	3"	8.38"	E02202	4,888	8	38	Stock	12033118
3" x 5"	3"	8.38"	E02203	1,073	8	38	Stock	12033118
4" x 2.5"	3"	8.38"	E02204	2,095	4	26	Stock	12234118
4" x 6"	3"	8.38"	E03444	897	4	26	Stock	12234118

MEDIA FOR INDUSTRIAL PRINTERS

Duratran II Valeron Film Tags

A premium performance polyethylene tag with excellent tear resistance. Excellent choice when attaching with thin gauge wire or when staples are used. Demonstrates excellent print quality when printed with the TMX2202 Mid-Range ribbon.

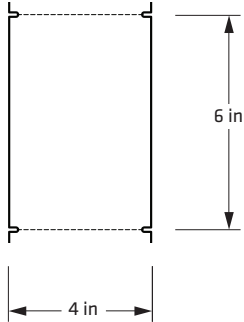

E12982

Size	ID	OD	Part Number	Qty/Roll	Rolls/Ctn	Ctn Weight	Stock/MTO	PD/PM/PX Ribbon
4" x 6"	3"	8.38"	E12982	916	4	26	Stock	12234118

Duratran II Gloss Polyester Labels

A high-gloss, top-coated polyester label with exceptional print quality. Excellent tear, smear and abrasion resistance; highly moisture and heat resistant. Product is UL recognized when printed with Intermec TMX3202 ribbons. High-tack adhesive.

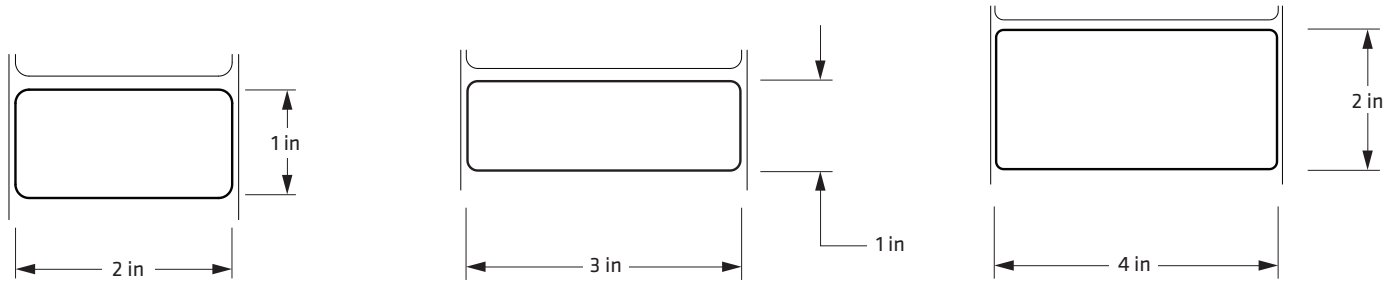

E10164

E23068

E23222

Size	ID	OD	Part Number	Qty/Roll	Rolls/Ctn	Ctn Weight	Stock/MTO	PD/PM/PX Ribbon
2" x 1"	3"	8.38"	E10164	5,333	8	25	Stock	13632018
3" x 1"	3"	8.38"	E23068	5,333	4	19	Stock	13633018
4" x 2"	3"	8.38"	E23222	3,000	8	51	Stock	13634118

MEDIA FOR INDUSTRIAL PRINTERS

ThermaMAX 1000 Wax Ribbons

A general-purpose, smear-resistant wax ribbon providing good durability when printing on Duratran™ II Papers and Tags.

Width	Length	Part Number	Qty/Ctn	Ctn Weight	Stock/MTO	Wind	Printer
2"	18024"	11232018	36	22	Stock	CSI	PD/PM/PX4i
3"	6000"	11023006	12	7	Stock	CSO	3400
3"	18024"	11233018	24	30	Stock	CSI	PD/PM/PX
4.1"	6,000"	11084106	12	6	Stock	CSO	3400
4.1"	18024"	11234118	24	27	Stock	CSI	PD/PM/PX
4.1"	18,000"	11064118	12	14	Stock	CSO	4420

ThermaMAX 2000 Mid-Range Ribbons

A mid-range ribbon that provides enhanced abrasion/smear resistance and high image quality when used with Duratran II coated papers and across the Intermec Mid-Range Film product line.

Width	Length	Part Number	Qty/Ctn	Ctn Weight	Stock/MTO	Wind	Printer
2"	18024"	12232018	24	22	Stock	CSI	PD/PM/PX4i
2.09"	6000"	12022006	18	6	Stock	CSO	3240/3400
3"	6000"	12023006	18	7	Stock	CSO	3400
3.15"	18000"	12033118	24	22	Stock	CSI	PD/PM/PX
4.1"	6,000"	12084106	12	7	Stock	CSO	3400
4.1"	18024"	12234118	12	27	Stock	CSI	PD/PM/PX
4.1"	18,000"	12064118	12	14	Stock	CSO	4420

ThermaMAX 3000 Resin Ribbons

A high quality resin ribbon for applications that require the optimum level of smear and abrasion resistance. Excellent imaging and performance across the Intermec Ultra-Durable Film product line. UL Recognized when used with Intermec Duratran II Gloss Polyester Labels.

Width	Length	Part Number	Qty/Ctn	Ctn Weight	Stock/MTO	Wind	Printer
2.1"	18036"	13632018	24	12	Stock	CSI	PD/PM/PX4i
3"	6000"	13023006	36	17	Stock	CSO	3400
3"	18036"	13633018	24	18	Stock	CSI	PD/PM/PX
4.1"	6,000"	13084106	24	12	Stock	CSO	3400
4.1"	18036"	13634118	24	24	Stock	CSI	PD/PM/PX
4.1"	18,000"	13064118	24	27	Stock	CSO	4420

Desktop



Industrial



Mobile



APPENDIX

Direct Thermal vs. Thermal Transfer

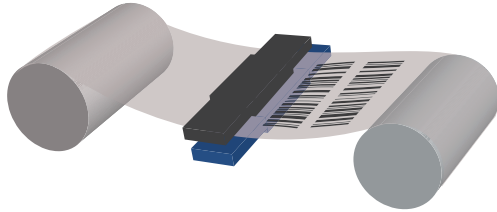

Direct Thermal Media Explained

Direct Thermal media uses a transparent heat-sensitive coating applied to its surface to image text and bar codes. When the heat from the print head contacts the coating, it initiates a chemical reaction that turns the coating black.

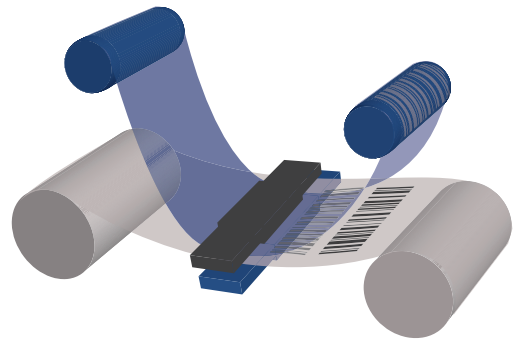

Thermal Transfer Media Explained

Thermal Transfer media uses a ribbon to image the text and bar codes on a variety of materials, both paper and film. When the ribbon is passed beneath the print head, the heat softens the ribbon ink while in contact with the label or tag, resulting in the transfer of the ink to the surface of the label or tag. There are three general classes of ribbons that are used in thermal printers: Wax, Mid-range, and Resin.

Wax ribbons are the most commonly used class and are mostly targeted to print paper labels and tags that will be exposed to relatively benign environments. Wax ribbons are also used to print on film labels and tags in some applications.

Mid-range ribbons are a hybrid design where resin is mixed with the wax to produce ribbons with durability properties that fall somewhere between the wax and resin ribbons. Mid-range ribbons are used to print on both paper and film labels and tags.

Resin ribbons are the most durable and are mostly targeted to printing on film labels and tags that will be exposed to extreme environments.

Ask about Intermec's

Free Printhead Replacement Program*

- Provides no-cost printhead replacement for all Intermec fixed printers
- Lowers total cost of ownership, speeds up return on investment
- Applies to all Intermec media supplies

*Conditions apply. See www.intermec.com



North America

6001 36th Avenue West
Everett, Washington 98203
Phone: (425) 348 2600
Fax: (425) 355 9551

North Latin America

Mexico
Phone: (+52) 55 52 41 48 00
Toll Free NOLA:
01800 490 4990

South Latin America

Brazil
Phone: (+55) 11 3711 6770
Fax: (+55) 11 5502 6780

Europe, Middle East & Africa

Reading, United Kingdom
Phone: (+44) 118 923 0800
Fax: (+44) 118 923 0801

Asia Pacific

Singapore
Phone: (+65) 6303 2100
Fax: (+65) 6303 2199

Media Sales

EMEA: (+31) 24 372 3167
USA: (513) 874 5882
<http://intermec.custhelp.com>

Sales

Toll Free NA: (800) 934 3163
Toll in NA: (425) 348 2726
Freephone ROW:
00800 4488 8844

OEM Sales

Phone: (425) 348 2762

Customer Service & Support

Toll Free NA: (800) 755 5505
Toll in NA: (425) 356 1799
EMEA: intermec.custhelp.com

Internet

www.intermec.com

Worldwide Locations

www.intermec.com/locations



www.L-TronDirect.com

800-830-9523

info@L-Tron.com

596 Fishers Station Dr | Victor, NY | 14564 | Suite 1 A

www.L-Tron.com

Get in touch with us
on social media!

