

DS9208

Quick Start Guide



<http://www.motorola.com/ds9208>

See Product Reference Guide for detailed information

CORD ATTACHMENT

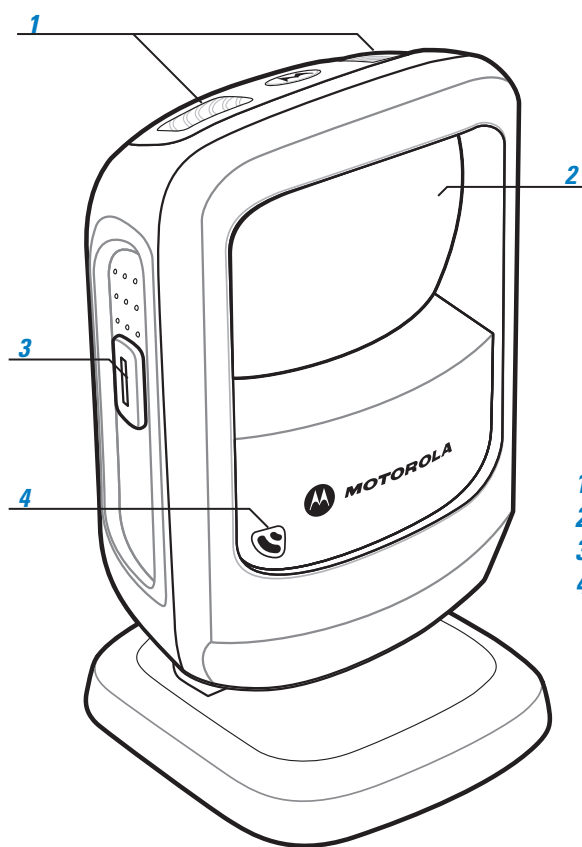

- 1 LED Indicators
- 2 Scan Window
- 3 Scan Trigger
- 4 Beeper

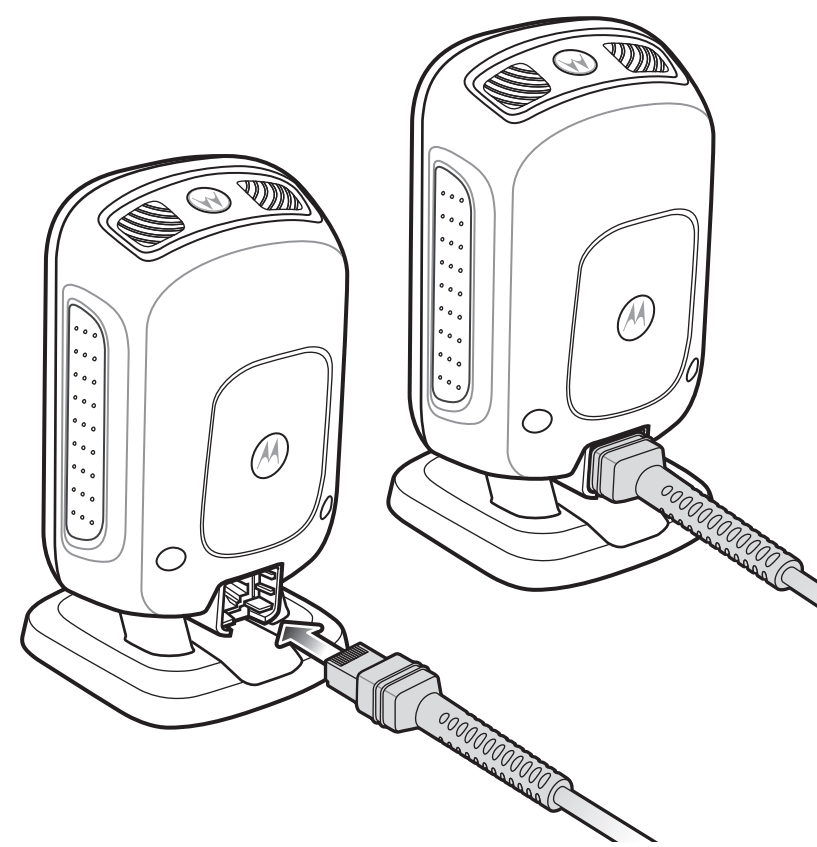

WALL MOUNTING

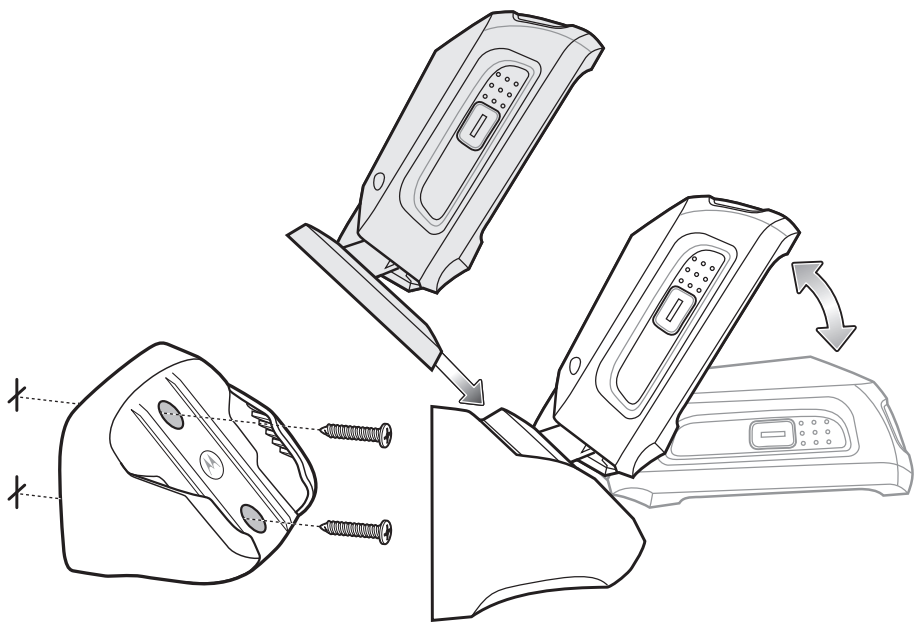
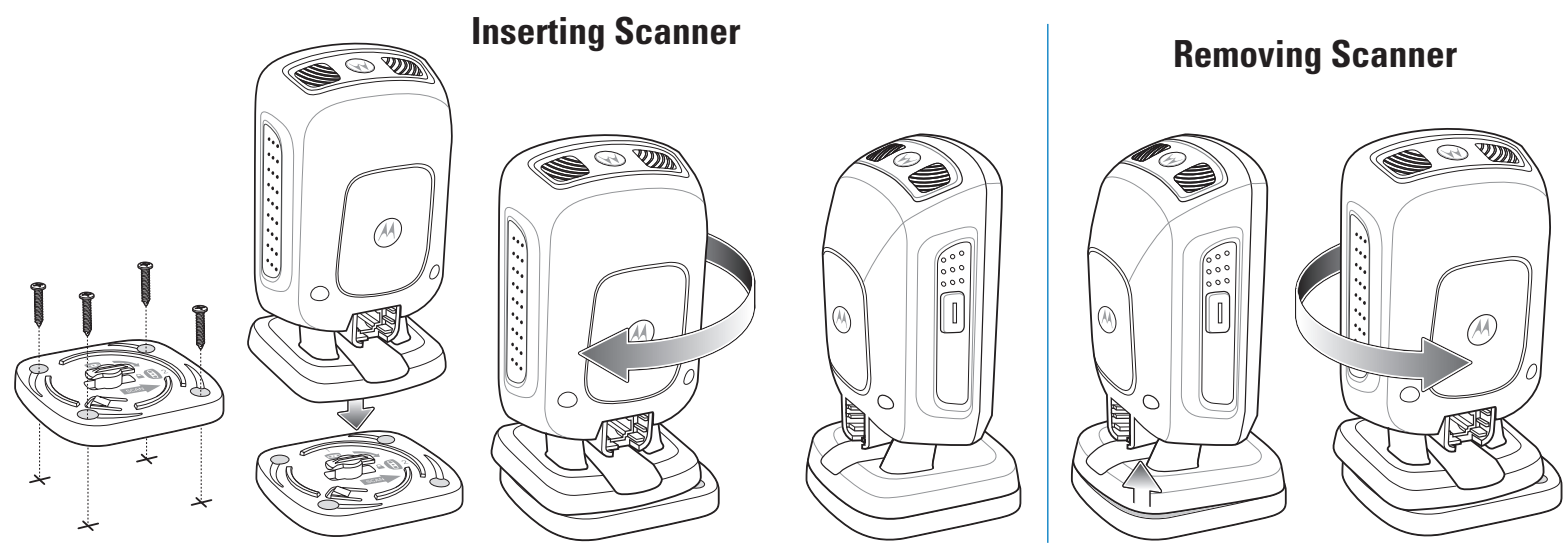

TABLE TOP MOUNTING



HOST INTERFACES

NOTE: Cables may vary depending on configuration

RS-232

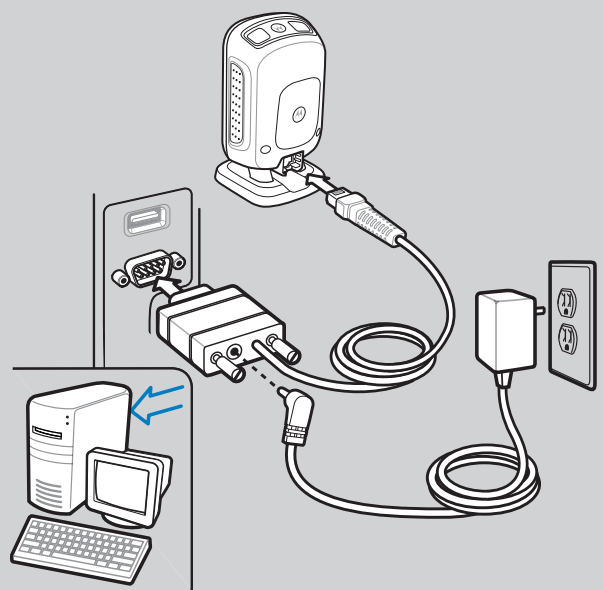

USB

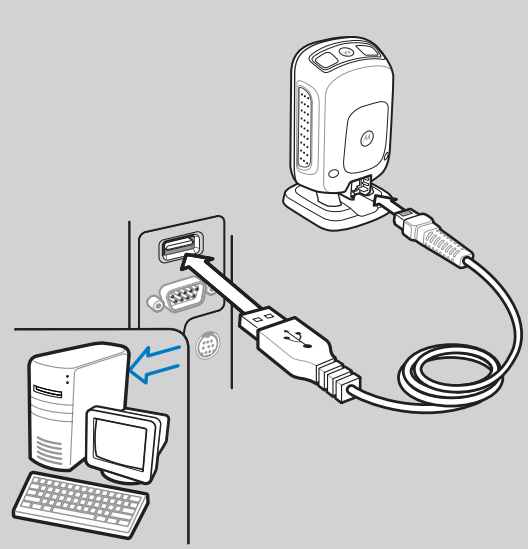

Keyboard Wedge

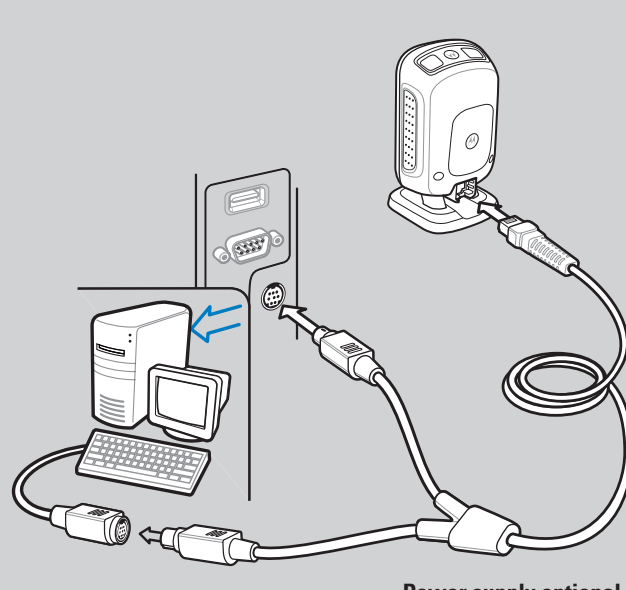

Power supply optional

IBM 46XX

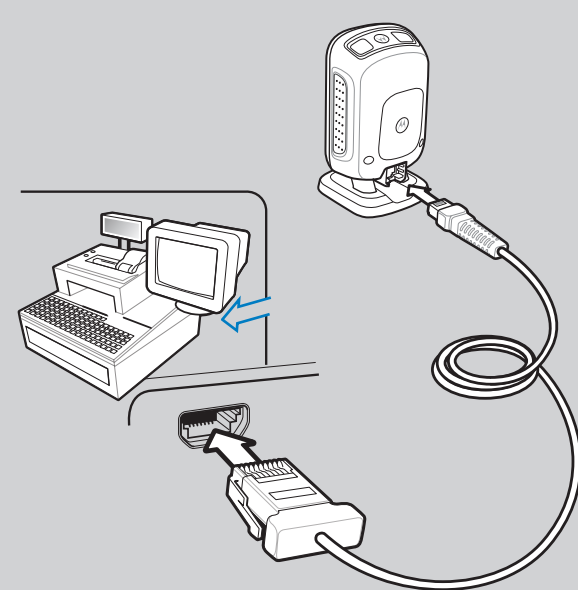

TROUBLESHOOTING

Scanner not working

- No power to scanner**
Check system power; ensure power supply, if required, is connected
- Incorrect interface cable used**
Ensure that correct interface cable is used
- Interface/power cables are loose**
Ensure all cable connections are secure

Scanner not decoding bar code

- Scanner not programmed for bar code type**
Ensure scanner is programmed to read type of bar code being scanned
- Bar code unreadable**
Ensure bar code is not defaced; try scanning test bar code of same bar code type; ensure bar code is not defaced; try scanning test bar code of same bar code type
- Distance between scanner and bar code incorrect**
Move scanner closer to or further from bar code

Scanner decoding bar code, but data not transmitting to host

- Scanner not programmed for correct host interface**
Scan appropriate host parameter bar codes
- Interface cable is loose**
Ensure all cable connections are secure

Scanned data incorrectly displayed on host

- Scanner not programmed for correct host interface**
Scan appropriate host parameter bar codes

DS9208 PROGRAMMING BAR CODES

Set Defaults



SET DEFAULTS

Enter Key (Carriage Return/Line Feed)



<DATA><SUFFIX 1>

IBM 46XX Host Types



PORT 5B



PORT 9B

USB Host Types



HID KEYBOARD EMULATION



SNAP! WITH IMAGING

Keyboard Wedge Host Types



IBM PC/AT and IBM PC COMPATIBLE



PORT 17

IBM HAND-HELD USB



IBM HAND-HELD USB



SNAP! WITHOUT IMAGING

Scan ONE of the following country types



NORTH AMERICAN



ITALIAN

RS-232 Host Types



STANDARD RS-232



NIXDORF RS-232 MODE B



FRENCH



SWEDISH



ICL RS-232



FUJITSU RS-232



FRENCH CANADIAN



UK ENGLISH



NIXDORF RS-232 MODE A



OPOS/JPOS



GERMAN



JAPANESE



SPANISH

Hands-Free Scanning

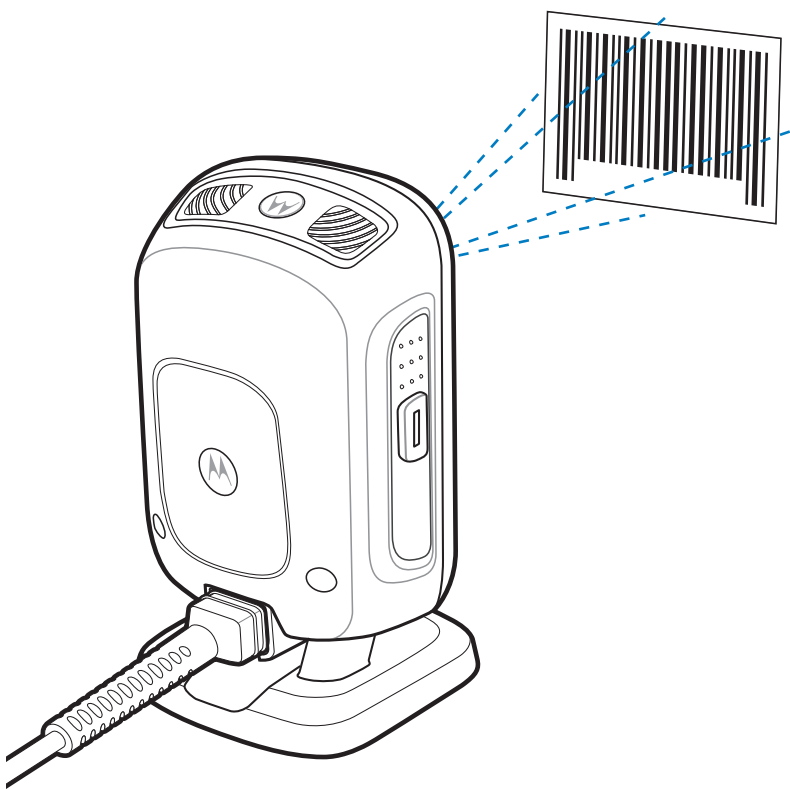

Hand-Held Scanning

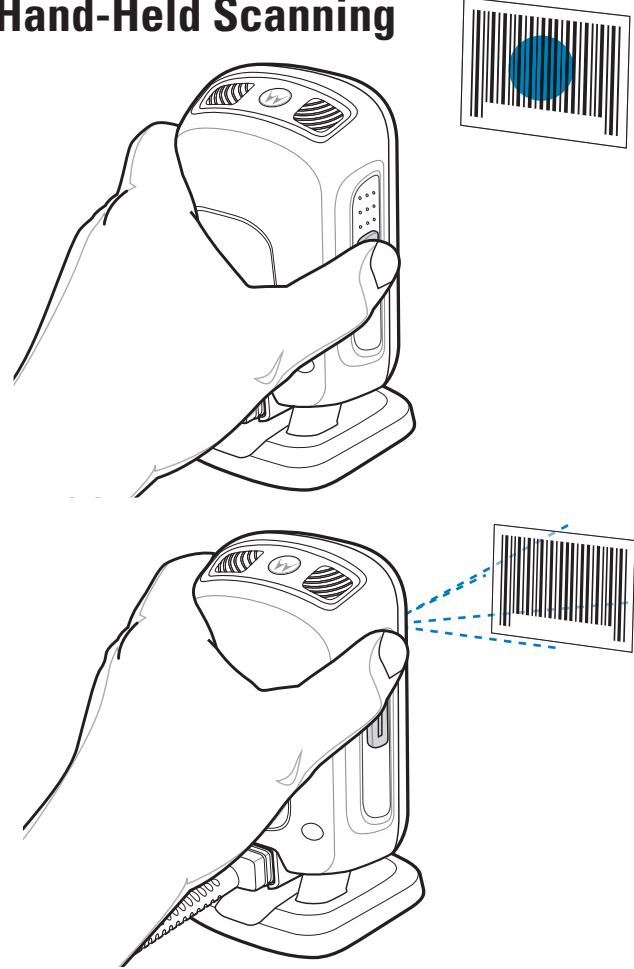

Aiming



OPTIMUM ARM POSITION



AVOID EXTREME WRIST ANGLES

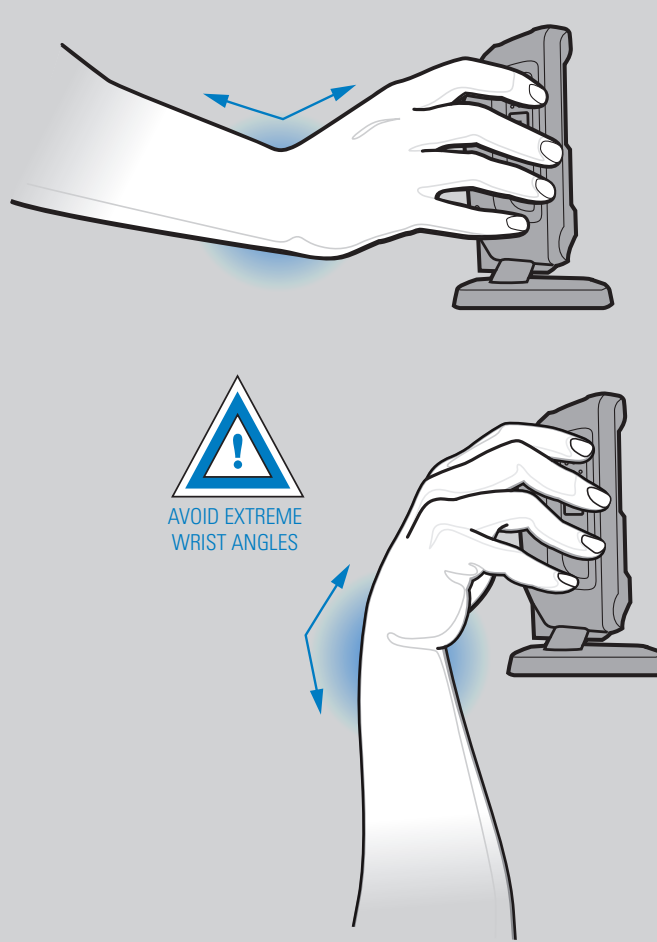

AVOID BENDING AND REACHING

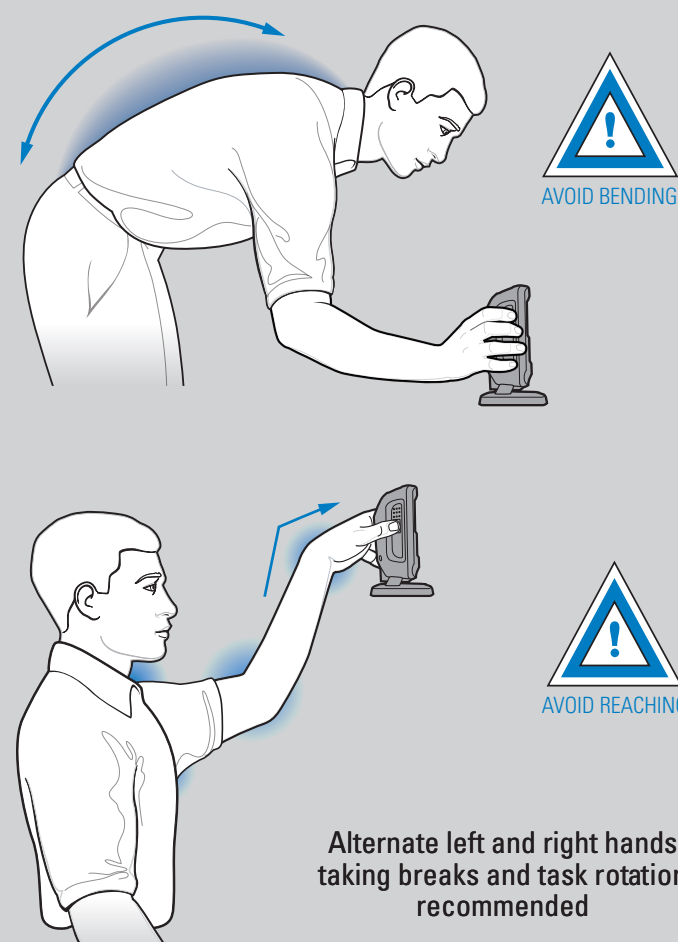

BEEPER INDICATIONS

Standard Use

Low/medium/high beep	Short medium beep	4 long low beeps
Power up	Bar code decoded	Transmission error detected; data is ignored

Parameter Menu Scanning

High/low/high/low beep	High/low beep	Low/high beep
Successful parameter setting	Correct programming sequence performed	Incorrect programming sequence or "Cancel" bar code scanned

LED INDICATIONS

Hand-Held Scanning

Off	Green	Red
Scanner is on and ready to scan, or no power to scanner	Bar code is successfully decoded	Transmission error

Hands-Free (Presentation) Scanning

Off	Green	Off Momentarily	Red
No power to scanner	Scanner is ready to scan	Bar code is successfully decoded	Transmission Error

Local Contact:

123SCAN²

123Scan² is an easy-to-use, PC-based software tool that enables rapid and easy customized setup via a bar code or USB cable. For more information, visit: <http://www.motorola.com/123Scan2>.

REGULATORY INFORMATION

© 2011 MOTOROLA SOLUTIONS, INC. All rights reserved. Motorola reserves the right to make changes to any product to improve reliability, function, or design. Motorola does not assume any product liability arising out of, or in connection with, the application or use of any product, circuit, or application described herein. No license is granted, either expressly or by implication, estoppel, or otherwise under any patent right or patent, covering or relating to any combination, system, apparatus, machine, material, method, or process in which Motorola products might be used. An implied license exists only for equipment, circuits, and subsystems contained in Motorola products. MOTOROLA, MOTO, MOTOROLA SOLUTIONS and the Stylized M Logo are trademarks or registered trademarks of Motorola Trademark Holdings, LLC and are used under license. All other trademarks are the property of their respective owners.

This Motorola Product may include Motorola Software, Commercial Third Party Software, and Publicly Available software. Refer to *Product Reference Guide* for complete copyright, conditions and disclaimer information.

Warranty
For the complete Motorola hardware product warranty statement, go to: <http://www.motorola.com/enterprisemobility/warranty>.

Service Information
If you have a problem using the equipment, contact your facility's Technical or Systems Support. If there is a problem with the equipment, they will contact Motorola Solutions Support at: <http://www.motorolasolutions.com/support>.

For the latest version of this guide go to: <http://www.motorolasolutions.com/support>.

Waste Electrical and Electronic Equipment (WEEE)

English: For EU Customers: All products at the end of their life must be returned to Motorola for recycling. For information on how to return product, please go to: <http://www.motorola.com/recycling/weee>.

Български: За клиенти от ЕС: След края на ползването им всички продукти трябва да се връщат на Motorola за рециклиране. За информация относно връщането на продукта, моля посетете нас на адрес: <http://www.motorola.com/recycling/weee>.

Ceština: Pro zákazníky z EU: Všechny produkty je nutné po skončení jejich životnosti vrátit společnosti Motorola k recyklaci. Informace o způsobu vrácení produktu najdete na webové stránce: <http://www.motorola.com/recycling/weee>.

Dansk: Til kunder i EU: Alle produkter skal returneres til Motorola til recykling, når de er udtjente. Læs oplysningerne om returnering af produkter på: <http://www.motorola.com/recycling/weee>.

Deutsch: Für Kunden innerhalb der EU: Alle Produkte müssen am Ende ihrer Lebensdauer zum Recycling an Motorola zurückgesandt werden. Informationen zur Rücksendung von Produkten finden Sie unter <http://www.motorola.com/recycling/weee>.

Eesti: Et klientidele: kõik tooted tuleb nende elutsükli lõppedes tagastada taaskasutamise eesmärgil Motorolale. Lisainformatsiooni saamiseks loetle tagastamise kohta külastage palun aadressil: <http://www.motorola.com/recycling/weee>.

Español: Para clientes en la Unión Europea: todos los productos deberán entregarse a Motorola al final de su ciclo de vida para que sean reciclados. Si desea más información sobre cómo devolver un producto, visite: <http://www.motorola.com/recycling/weee>.

Franciais: Clients de l'Union Européenne: Tous les produits en fin de cycle de vie doivent être retournés à Motorola pour recyclage. Pour de plus amples informations sur le retour de produits, consultez: <http://www.motorola.com/recycling/weee>.

Italiano: per i clienti dell'UE: tutti i prodotti che sono giunti al termine del rispettivo ciclo di vita devono essere restituiti a Motorola al fine di consentire il riciclaggio. Per informazioni sulle modalità di restituzione, visitare il seguente sito Web: <http://www.motorola.com/recycling/weee>.

Lituanian: ES klientams: vis produktus po to naudojimo reikia grąžinti į kompaniją Motorola. Daugiau informacijos, kaip grąžinti gamini, rasite: <http://www.motorola.com/recycling/weee>.

Magyar: Az EU-ban vásárlóknak: Minden termékemet terméket a Motorola vállalatához kell eljuttatni újrahasznosítás céljából. A termék visszatartásának módjával kapcsolatos tudnivalókat látogasson el a <http://www.motorola.com/recycling/weee> weboldala.

Malis: Chal klienti iz EU: vrnostni vsa hla juna vsaka l'har lahaja tar kuzu taghom, inu jgu rrtomat ghand Motorola ghar-riklaga. Chal aktar taghr' d'war kif ghrntime tirntoma kprodott, jek jgh'ghok zur: <http://www.motorola.com/recycling/weee>.

Nederlands: Voor klanten in de EU: alle producten dienen aan het einde van hun levensduur naar Motorola te worden teruggezonden voor recycling. Raadpleeg <http://www.motorola.com/recycling/weee> voor meer informatie over het terugzenden van producten.

Polski: Klienci z obszaru Unii Europejskiej: Produkty wycofane z eksploatacji należy zwrócić do firmy Motorola w celu ich utylizacji. Informacje na temat zwrotu produktów znajdują się na stronie internetowej: <http://www.motorola.com/recycling/weee>.

Portuguese: Para clientes da UE: todos os produtos no fim de vida devem ser devolvidos à Motorola para reciclagem. Para obter informações sobre como devolver o produto, visite: <http://www.motorola.com/recycling/weee>.

Romanes: Pentru clienti din UE: Toate produsele, la sfârșitul duratei lor de funcționare, trebuie returnate la Motorola pentru reciclare. Pentru informații despre returnarea produsului, vizitați: <http://www.motorola.com/recycling/weee>.

Slovenian: Pro zákazníkov z krajin EU: Všetky výrobky musia byť po uplnutí doby ich životnosti vrátené spoločnosti Motorola na recykláciu. Bláše informácie o vrátení výrobkov nájdete na: <http://www.motorola.com/recycling/weee>.

Slovenski: Za kupce v EU: vsi izdelki se morajo po obisku življenjske dobe vrniti podjetju Motorola za reciklazo. Za informacije o vrnitvi izdelka obiščite: <http://www.motorola.com/recycling/weee>.

Suomi: Asiakkaita Euroopan unionin alueella: Kaikki tuotteet on palautettava kierrätettäväksi Motorola-yhtiöön, kun tuotetta ei enää käytetä. Lisätietoja tuotteen palauttamisesta on osoitteella: <http://www.motorola.com/recycling/weee>.

Svenska: För kunder inom EU: Alla produkter som uppnått sin livslängd måste returneras till Motorola för återvinning. Information om hur du returnerar produkten finns på <http://www.motorola.com/recycling/weee>.

Türkçe: AB Müşterileri için: Kullanım süresi dolan tüm ürünleri geri dönüştürme için Motorola'ya iade ediniz. Ürünleri nasıl iade edileceği hakkında bilgi için lütfen şu adresi ziyaret edin: <http://www.motorola.com/recycling/weee>. **EE: Yhteisöjien kirjandus**

Ergonomic Recommendations

Caution: In order to avoid or minimize the potential risk of ergonomic injury follow the recommendations below. Consult with your local Health & Safety Manager to ensure that you are adhering to your company's safety programs to prevent employee injury.

- Reduce or eliminate repetitive motion
- Maintain a natural position
- Reduce or eliminate excessive force
- Keep objects that are used frequently within easy reach
- Perform tasks at correct heights
- Reduce or eliminate vibration
- Reduce or eliminate direct pressure
- Provide adjustable workstations
- Provide adequate clearance
- Provide a suitable working environment
- Improve work procedures.

Regulatory Information

This guide applies to Model Number DS9208.

All Motorola devices are designed to be compliant with rules and regulations in locations they are sold and will be labeled as required.

Local language translations are available at the following website: <http://www.motorolasolutions.com/support>.

Any changes or modifications to Motorola equipment, not expressly approved by Motorola, could void the user's authority to operate the equipment. Declared maximum operating temperature: 40° C / 104° F.

Radio Frequency Interference Requirements

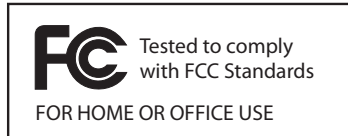

Note: This equipment has been tested and found to comply with the limits for a Class B digital device, pursuant to Part 15 of the FCC rules. These limits are designed to provide reasonable protection against harmful interference in a residential installation. This equipment generates, uses and can radiate radio frequency energy and, if not installed and used in accordance with the instruction manual, may cause harmful interference to radio communications. However there is no guarantee that interference will not occur in a particular installation. If this equipment does cause harmful interference to radio or television reception, which can be determined by turning the equipment off and on, the user is encouraged to try to correct the interference by one or more of the following measures:

- Reorient or relocate the receiving antenna
- Increase the separation between the equipment and receiver
- Connect the equipment into an outlet on a circuit different from that to which the receiver is connected
- Consult the dealer or an experienced radio/TV technician for help.

Radio Frequency Interference Requirements – Canada

This Class B digital apparatus complies with Canadian ICES-003. Cet appareil numérique de la classe B est conforme à la norme NMB-003 du Canada.

Marking and European Economic Area (EEA)



Statement of Compliance

Motorola hereby declares that this device is in compliance with all the applicable Directives, 2004/108/EC and 2006/95/EC. A Declaration of Conformity may be obtained from <http://www.motorola.com/doc>.

EAS

System integrator to ensure final product is compliant with all applicable EU Directives.

<http://www.motorola.com/ds9208>

Japan (VCCI) - Voluntary Control Council for Interference

Class B ITE
この装置は、情報処理装置等電波障害自主規制協議会(VCCI)の基準に基づくクラスB情報技術装置です。この装置は、家庭環境で使用することを目的としていますが、この装置がラジオやテレビジョン受信機に近接して使用されると、受信障害を引き起こすことがあります。取扱説明書に従って正しい取り扱いをして下さい。

This is a Class B product based on the standard of the Voluntary Control Council for Interference from Information Technology Equipment (VCCI). If this is used near a radio or television receiver in a domestic environment, it may cause radio interference. Install and use the equipment according to the instruction manual.

Korea Warning Statement for Class B ITE

Class B (Broadcasting Communication Device for Home Use)	User's Guide This device obtained EMC registration mainly for home use (Class B) and may be used in all areas.
--	---

기종별
B급 기기
(가정용 방송통신기기)

사용자 안내문
이 기기는 가정용(B급)으로 전자파적합등록을 한 기기로서 주로 가정에서 사용하는 것을 목적으로 하며, 모든 지역에서 사용할 수 있습니다.

Power Supply

Use ONLY a LISTED Motorola, Type no. PWRS-14000 (5Vdc, 850mA), direct plug-in power supply, marked Class 2 or LPS (IEC60950-1, SELV). Use of alternative Power Supply will invalidate any approvals given to this unit and may be dangerous.

LED Devices

Complies with IEC/EN60825-1:2001 & EN 62471: 2006 and IEC62471: 2008.

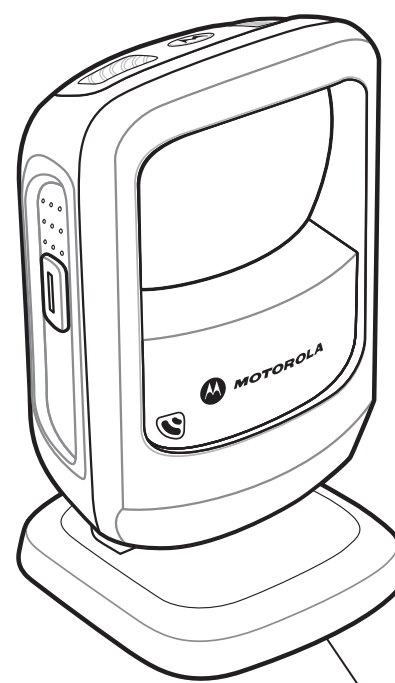

LED LIGHT DO NOT VIEW DIRECTLY WITH OPTICAL INSTRUMENTS CLASS 1M LED PRODUCT
LED-LICHT SEHEN SIE NICHT DIREKT MIT OPTISCHEN INSTRUMENT AN PRODUKT DER KATEGORIEN-1M LED
LUMIERE DE LED NE REGARDÉZ PAS DIRECTEMENT AVEC LES INSTRUMENTS OPTIQUES PRODUIT DE LA CLASSE 1M LED
LED 光 直接地用光学仪器不要观看 类 1M LED 产品

Caution - use of controls or adjustments or performance of procedures other than those specified herein may result in hazardous light exposure.



72-140088-01 Revision B November 2011





www.L-TronDirect.com

800-830-9523

info@L-Tron.com

596 Fishers Station Dr | Victor, NY | 14564 | Suite 1 A

www.L-Tron.com

Get in touch with us
on social media!

