

# Enterprise Wireless LAN Antenna

## Specification Guide

*Version 2.9 Revision A August 2015*

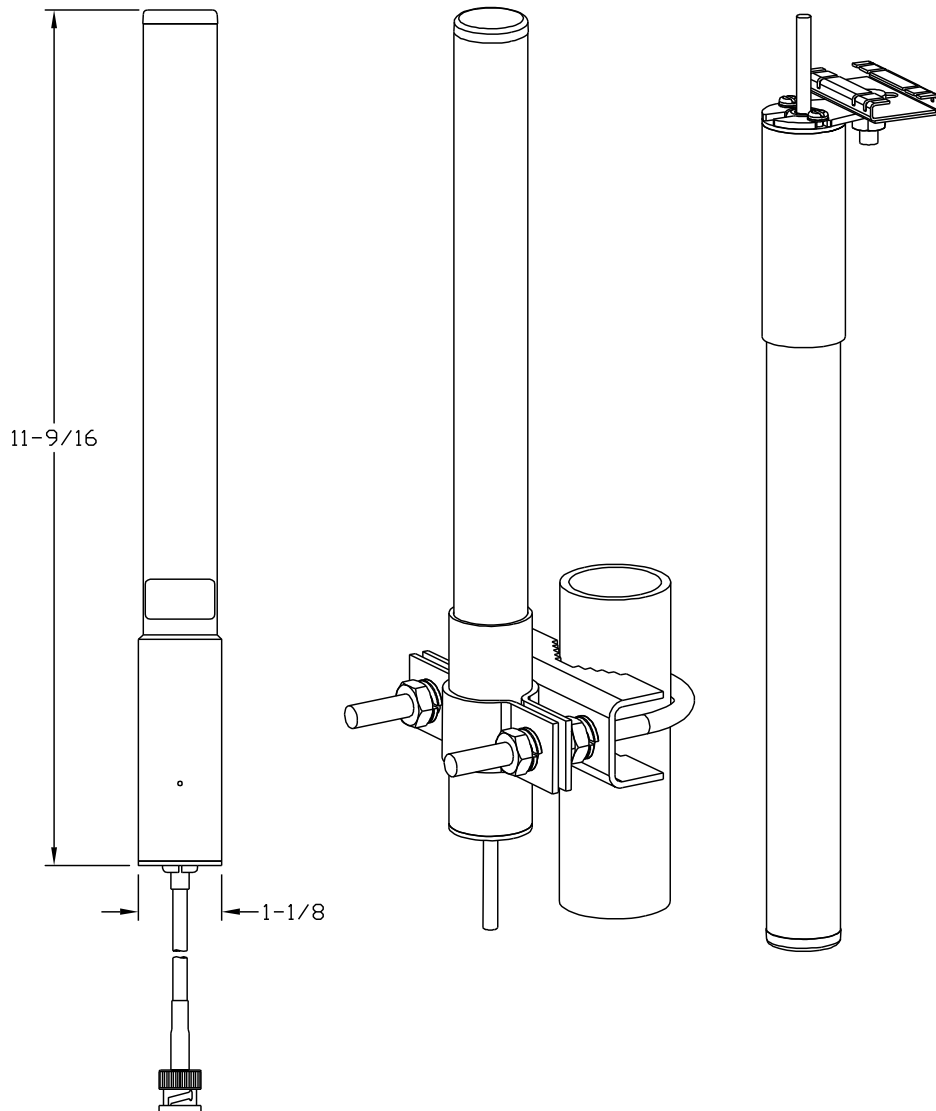

Zebra and the Zebra head graphic are registered trademarks of ZIH Corp. The Symbol logo is a registered trademark of Symbol Technologies, Inc., a Zebra Technologies company.

© 2015 Symbol Technologies, Inc.

# About This Guide

## Introduction

This guide provides a Professional RF engineer a catalog of antennas, parts, and accessories to complete a customized RF installation of Access Points. This guide specifically addresses the antennas used for 2.4 GHz, 5.2 GHz and dual band antenna implementations for *Wireless Local Area Networks* (WLANs).

It's important to understand that antenna and accessory selection should be qualified by on-site verification with the actual components used. Signal attenuation is cumulative with each connection and component added between the antenna and the radio, so careful study and planning should be used to verify the given arrangement ensures a compliant installation.



**NOTE:** Illustrations displayed in this guide are samples and can differ from the actual antenna.

---

---

## Document Conventions

The following conventions are used in this document to draw your attention to important information:



**NOTE:** Indicate tips or special requirements.

---

---



**CAUTION:** Indicates conditions that can cause equipment damage or data loss.

---

---



**WARNING!** Indicates a condition or procedure that could result in personal injury or equipment damage.

---

---

## ***Notational Conventions***

The following additional notational conventions are used in this document:

- *Italics* are used to highlight the following:
  - Chapters and sections in this and related documents
  - Dialog box, window and screen names
  - Drop-down list and list box names
  - Check box and radio button names
  - Icons on a screen.
- **GUI** text is used to highlight the following:
  - Screen names
  - Menu items
  - Button names on a screen.
- bullets (•) indicate:
  - Action items
  - Lists of alternatives
  - Lists of required steps that are not necessarily sequential
- Sequential lists (those that describe step-by-step procedures) appear as numbered lists.

# Contents

## Chapter 1. Antenna Selection and Description

1.1 Antenna Selection .....	1-1
1.2 Antenna Selection Criteria .....	1-6
1.3 Antenna Accessories for Enterprise WLANs .....	1-7

## Chapter 2. Product Compatibility

2.1 FCC Compliance .....	2-1
2.2 FCC Approval Statement .....	2-3
2.3 FCC USA Compatibility Matrix .....	2-6

## Chapter 3. 2.4 GHz Single Band Antenna Suite

3.1 Supported 802.11b/g/n Antenna Suite .....	3-1
---	-----

## Chapter 4. 5.2 Ghz Single Band Antenna Suite

4.1 Supported 802.11a/n Antenna Suite .....	4-1
---	-----

## Chapter 5. 2.4GHz - 5.2GHz Dual Band Antenna Suite

5.1 Supported 802.11a/b/g/n Dual Band Antennas .....	5-1
--	-----

## Chapter 6. Antenna Cables

6.1 Supported Antenna Cables .....	6-1
------------------------------------	-----

## Chapter 7. Supported Antenna Adapters

7.1 Supported Adapters .....	7-1
------------------------------	-----

## Chapter 8. Supported Lightning Arrestors

8.1 Lightning Arrestors .....	8-1
-------------------------------	-----

## Chapter 9. Mounting Kits

9.1 Mounting Kit Support .....	9-1
--------------------------------	-----

## Chapter 10. AP7131 Regulatory Domains

10.1 Supported Antennas by Band, Model, Rate and Transmit Power .....	10-1
10.2 US Regulatory Domain 2.4 GHz Band .....	10-2
10.3 US Regulatory Domain 5.2 GHz Band .....	10-7

10.4 Japan Regulatory Domain 2.4 GHz Band .....	10-17
10.5 Japan Regulatory Domain 5.2 GHz Band .....	10-21

## Chapter 11. AP650 Regulatory Domains

11.1 US Regulatory Domain 2.4 GHz Band .....	11-1
11.2 US Regulatory Domain 5 GHz Band .....	11-6
11.3 Japan Regulatory Domain 2.4 GHz Band .....	11-18
11.4 Japan Regulatory Domain 5 GHz Band .....	11-24
11.5 EU Regulatory Domain 2.4 GHz Band .....	11-36
11.6 EU Regulatory Domain 5 GHz Band .....	11-41

## Chapter 12. RFS4011 Regulatory Domains

12.1 US Regulatory Domain 2.4 GHz Band .....	12-1
12.2 US Regulatory Domain 5 GHz Band .....	12-5
12.3 Canada Regulatory Domain 2.4 GHz Band .....	12-13
12.4 Canada Regulatory Domain 5 GHz Band .....	12-17
12.5 EU Regulatory Domain 2.4 GHz Band .....	12-25
12.6 EU Regulatory Domain 5 GHz Band .....	12-29
12.7 Japan Regulatory Domain 2.4 GHz Band .....	12-37
12.8 Japan Regulatory Domain 5 GHz Band .....	12-41

## Chapter 13. AP-6511 Regulatory Domains

13.1 US Regulatory Domain 2.4 GHz Band .....	13-1
13.2 US Regulatory Domain 5 GHz Band .....	13-2
13.3 EU Regulatory Domain 2.4 GHz Band .....	13-3
13.4 EU Regulatory Domain 5 GHz Band .....	13-4
13.5 Japan Regulatory Domain 2.4 GHz Band .....	13-6
13.6 Japan Regulatory Domain 5 GHz Band .....	13-7

## Chapter 14. AP-621 and AP-6521 Regulatory Domains

14.1 AP-621 (Standard Power) US Regulatory Domain 2.4GHz Band .....	14-1
14.2 AP-621 (Standard Power) US Regulatory Domain 5GHz Band .....	14-5
14.3 AP-6521 (High Power) US Regulatory Domain 2.4GHz Band .....	14-13
14.4 AP-6521 (High Power) US Regulatory Domain 5GHz Band .....	14-17
14.5 AP-621 (Standard Power) EU Regulatory Domain 2.4GHz Band .....	14-25
14.6 AP-621 (Standard Power) EU Regulatory Domain 5GHz Band .....	14-29
14.7 AP-6521 (High Power) EU Regulatory Domain 2.4GHz Band .....	14-37
14.8 AP-6521 (High Power) EU Regulatory Domain 5GHz Band .....	14-41
14.9 AP-621 (Standard Power) Japan Regulatory Domain 2.4GHz Band .....	14-49
14.10 AP-621 (Standard Power) Japan Regulatory Domain 5GHz Band .....	14-53
14.11 AP-6521 (High Power) Japan Regulatory Domain 2.4GHz Band .....	14-61
14.12 AP-6521 (High Power) Japan Regulatory Domain 5GHz Band .....	14-65

## Chapter 15. AP622, AP6522 and AP6562 Regulatory Domains

15.1 US Regulatory Domain 2.4 GHz Band .....	15-1
15.2 US Regulatory Domain 5 GHz Band .....	15-6
15.3 EU Regulatory Domain 2.4 GHz Band .....	15-16
15.4 EU Regulatory Domain 5 GHz Band .....	15-21

15.5 Japan Regulatory Domain 2.4 GHz Band .....	15-31
15.6 Japan Regulatory Domain 5 GHz Band .....	15-36

## **Chapter 16. AP7161 Regulatory Domains**

16.1 US Regulatory Domain 2.4 GHz Band .....	16-1
16.2 US Regulatory Domain 4.9 GHz Band .....	16-2
16.3 US Regulatory Domain 5 GHz Band .....	16-3
16.4 EU Regulatory Domain 2.4 GHz Band .....	16-5
16.5 EU Regulatory Domain 5 GHz Band .....	16-6
16.6 Japan Regulatory Domain 2.4 GHz Band .....	16-8
16.7 Japan Regulatory Domain 5 GHz Band .....	16-9

## **Chapter 17. AP8132 Regulatory Domains**

17.1 US Regulatory Domain 2.4 GHz Band .....	17-1
17.2 US Regulatory Domain 5 GHz Band .....	17-6
17.3 EU Regulatory Domain 2.4 GHz Band .....	17-16
17.4 EU Regulatory Domain 5 GHz Band .....	17-20
17.5 Japan Regulatory Domain 2.4 GHz Band .....	17-30
17.6 Japan Regulatory Domain 5 GHz Band .....	17-35

## **Chapter 18. AP8122 Regulatory Domains**

18.1 US Regulatory Domain 2.4 GHz Band .....	18-1
18.2 US Regulatory Domain 5 GHz Band .....	18-2
18.3 EU Regulatory Domain 2.4 GHz Band .....	18-4
18.4 EU Regulatory Domain 5 GHz Band .....	18-5

## **Chapter 19. AP8163 Regulatory Domains**

19.1 US Regulatory Domain 2.4 GHz Band .....	19-1
19.2 US Regulatory Domain 5 GHz Band .....	19-5
19.3 EU Regulatory Domain 2.4 GHz Band .....	19-13
19.4 EU Regulatory Domain 5 GHz Band .....	19-17

## **Chapter 20. AP8232 Regulatory Domains**

20.1 US Regulatory Domain 2.4 GHz Band .....	20-1
20.2 US Regulatory Domain 5 GHz Band .....	20-6
20.3 EU Regulatory Domain 2.4 GHz Band .....	20-16
20.4 EU Regulatory Domain 5 GHz Band .....	20-20
20.5 Japan Regulatory Domain 2.4 GHz Band .....	20-30
20.6 Japan Regulatory Domain 5 GHz Band .....	20-35

## **Chapter 21. AP8222 Regulatory Domains**

21.1 US Regulatory Domain 2.4 GHz Band .....	21-1
21.2 US Regulatory Domain 5 GHz Band .....	21-2
21.3 EU Regulatory Domain 2.4 GHz Band .....	21-4
21.4 EU Regulatory Domain 5 GHz Band .....	21-5

21.5 Japan Regulatory Domain 2.4 GHz Band .....	21-7
21.6 Japan Regulatory Domain 5 GHz Band .....	21-8

## Chapter 22. AP7532 Regulatory Domains

22.1 US Regulatory Domain 2.4 GHz Band .....	22-1
22.2 US Regulatory Domain 5 GHz Band .....	22-4
22.3 EU Regulatory Domain 2.4 GHz Band .....	22-10
22.4 EU Regulatory Domain 5 GHz Band .....	22-13
22.5 Japan Regulatory Domain 2.4 GHz Band .....	22-19
22.6 Japan Regulatory Domain 5 GHz Band .....	22-22
22.7 NCC Domain .....	22-28

## Chapter 23. AP7522 Regulatory Domains

23.1 US Regulatory Domain 2.4 GHz Band .....	23-1
23.2 US Regulatory Domain 5 GHz Band .....	23-4
23.3 EU Regulatory Domain 2.4 GHz Band .....	23-10
23.4 EU Regulatory Domain 5 GHz Band .....	23-13
23.5 Japan Regulatory Domain 2.4 GHz Band .....	23-19
23.6 Japan Regulatory Domain 5 GHz Band .....	23-22
23.7 NCC Domain .....	23-28

## Chapter 24. AP7502 Regulatory Domains

24.1 US Regulatory Domain 2.4 GHz Band .....	24-1
24.2 US Regulatory Domain 5 GHz Band .....	24-2
24.3 EU Regulatory Domain 2.4 GHz Band .....	24-4
24.4 EU Regulatory Domain 5 GHz Band .....	24-5
24.5 Japan Regulatory Domain 2.4 GHz Band .....	24-7
24.6 Japan Regulatory Domain 5 GHz Band .....	24-8
24.7 NCC Regulatory Domain 2.4 GHz Band .....	24-10
24.8 NCC Regulatory Domain 5 GHz Band .....	24-11

## Chapter 25. AP7562 Regulatory Domains

25.1 US Regulatory Domain 2.4 GHz Band .....	25-1
25.2 US Regulatory Domain 5 GHz Band .....	25-4
25.3 EU Regulatory Domain 2.4 GHz Band .....	25-10
25.4 EU Regulatory Domain 5 GHz Band .....	25-13
25.5 Japan Regulatory Domain 2.4 GHz Band .....	25-19
25.6 Japan Regulatory Domain 5 GHz Band .....	25-22
25.7 NCC Domain .....	25-28

## Appendix A. Technical Support



# ***Antenna Selection and Description***

## **1.1 Antenna Selection**

While several antennas may work in a given environment, some will provide better coverage than others. Using the right antenna in the right location will maximize both the performance and coverage of your network. Understanding the key characteristics that describe how an antenna sends and receives radio frequency signals is critical to finding the ideal antenna for your deployment.

Enterprise Wireless LAN products operate in the 2.4 GHz and 5 GHz ISM bands allocated for unlicensed use. Access point and access port products available today support either the 802.11b/g/n or the 802.11a/n standard, or both. Wireless devices conforming to the 802.11b/g standard operate in the 2.4 GHz ISM band, while 802.11a devices operate in the 5 GHz band. The antennas in this guide are grouped according to the frequency band they support. Some antennas are designed to operate within either band. These antennas (described as "Dual-band") may be connected to radios operating in either the 2.4 or 5 GHz bands, although a single antenna may not be connected to two radios at the same time.

### 1.1.1 Connector Types and Definitions

There are combinations of antenna types and cables required to provide a satisfactory connection to the AP. One confusing factor is "reverse polarity". Reverse polarity is the FCC's requirement for each WLAN manufacturer to have unique access point connectors.

- 2.4 GHz is Reverse polarity BNC female (RP-BNC-F)
- 5 GHz is reverse polarity SMA female (RP-SMA-F).



**NOTE:** Reverse polarity presents confusion because of a lack of a standardized definition from connector manufactures. Reverse polarity provides a center element, which should not be confused with a male connector. A male connector is defined by the outer jacket of the connector rather than the center element.

The following are the connectors used within this guide:



Figure 1.1 RP-BNC-F



Figure 1.2 RP-BNC-M



**Figure 1.3 RP-SMA-F**



**Figure 1.4 RP-SMA-M**

Additionally, antennas deployed outdoors and industry standard accessories (like lightning arrestors) use Type-N connectors (as displayed below). Therefore, with the combinations devices required (access points/ports, antennas, cable extensions, and lightning arrestors), various adapter cables are required to connect an antenna to an access point/port.



**Figure 1.5 Type N-F**



**Figure 1.6 Type N-M**

### **1.1.2 Indoor and Outdoor Antennas**

One important aspect of an antenna is whether it is weather sealed to protect it from the environment. Because of this extra protection, outdoor antennas are typically more expensive than those rated for indoor use. Outdoor antennas can be used for indoor applications, such as freezers and cooler where moisture is common. Outdoor antennas can be used for indoor applications, but indoor applications should not be used in outdoor applications.

One common distinction of outdoor antennas is the connector. Since lightning protection is always advised for outdoor antennas, these antennas typically have Type N Male to directly attach the lightning arrestor. This is true of 2.4 GHz, 5 GHz, and dual-band outdoor antennas.

### **1.1.3 Spectrum and Part Number Designations**

The antennas listed in this document are ultimately referenced by part number. A numerical sequence is used within each antenna's part number to identify the spectrum supported by the antennas.

- The antenna part numbers with a 2499 indicates a 2.4 GHz antenna. For more information on the 2.4 GHz antenna suite, see *2.4 GHz Single Band Antenna Suite on page 3-1*.
- The antenna part numbers with a 5299 indicates a 5 GHz antenna. For more information on the 2.4 GHz antenna suite, see *5.2 Ghz Single Band Antenna Suite on page 4-1*.
- The antenna part numbers with a 2452 indicates a dual band antenna (2.4GHz and 5 GHz). For more information on the 2.4 GHz antenna suite, see *2.4GHz - 5.2GHz Dual Band Antenna Suite on page 5-1*.

### **1.1.4 Extended AP to Antenna Cable Lengths**

Most indoor antennas are intended to be mounted directly to the AP's connectors. Some mounting arrangements call for positioning the AP a significant distance away from the antenna due to serviceability or other reason. In these situations, various adapters and cable extensions are required.

In these situations be mindful of:

- The connector on the AP
- The connector on the antenna
- The spectrum being implemented
- Signal loss due to multiple connectors and long cable lengths

Combinations of these attributes present different parts required to complete the connection. The Product Compatibility matrix addresses the parts required to make a proper connection. For more information, see *FCC Compliance on page 2-1*.

## 1.2 Antenna Selection Criteria

In addition to antenna frequency, there is other criteria to consider when selecting an antenna.

### 1.2.1 Antenna Pattern

#### 1.2.1.1 Omni-Directional

Signal radiates from the antenna in all directions on the horizontal plane.

#### 1.2.1.2 Directional

Signal radiates in a specific direction, typically described as a beam of given width, expressed in degrees in the horizontal and vertical plane. For more information, see *Azimuth 3dB Beamwidth on page 1-7* and *Elevation 3dB Beamwidth on page 1-7*.

### 1.2.2 Antenna Type

#### 1.2.2.1 Panel

A panel antenna is a flat antenna mounted to a wall or other vertical surface and radiates RF energy (radio waves) directionally away from the wall. They usually have gain greater than 5 dBi and are not suitable for omni-directional situations. Ideally suited for long hallways.

#### 1.2.2.2 Patch

A patch antenna is a flat antenna mounted on the ceiling but whose pattern is omni-directional. Most of the energy goes out horizontally to the sides of the antenna and equal in all directions.

#### 1.2.2.3 Dipole

A dipole antenna is a tubular antenna that can be either a pipe shape, a straight flexible rod or a paddle. This antenna has an omni-directional pattern when placed in a vertical position. It usually has 2 dBi of gain.

#### 1.2.2.4 Dipole Array

Essentially a dipole, a dipole array is two or more dipoles that are placed one on top of the other, requiring a longer tube to hold them. The advantage of a dipole array is that it has higher gain.

#### 1.2.2.5 Parabolic Grid

A parabolic grid antenna is a very directional, dish-like antenna. Its parabolic reflector focuses the RF energy like a flashlight. Most of the time the radiating element is a dipole, but when combined with the dish, it becomes very directional with gain up to 24 dBi. Usually used in long point-to-point systems.

#### 1.2.2.6 Yagi

A yagi antenna is an antenna that has an internal structure resembling that of typical antennas used for TV reception (a series of rods perpendicular to a main rod, making a triangular shape). This is a directional antenna with less gain than the PGA, typically around 13 dBi. It may be used in either point-to-point situations, or to cover a very long, narrow area in point-to-multi-point situations.

## **1.2.3 Antenna Performance Characteristics**

### **1.2.3.1 Frequency**

The frequency band within which the antenna performs at the stated specifications

### **1.2.3.2 Gain (dBi)**

The relative amplification of the antenna with respect to an equivalent isotropic antenna, expressed on the decibel logarithmic scale.

### **1.2.3.3 Cable loss (dB)**

The signal strength loss introduced by the cable connected to the antenna expressed on the decibel logarithmic scale.

### **1.2.3.4 Net gain (dBi)**

The resulting amplification of the antenna paired with its cable.

### **1.2.3.5 Polarization**

The orientation of the electrical field which the antenna is optimized to receive. If the transmitting and receiving antennas are both linear polarized, then turning one 90° so that they are cross polarized will reduce the range significantly.

### **1.2.3.6 VSWR**

*Voltage Standing Wave Ratio* (VSWR) is the ratio of maximum voltage to minimum voltage along the line. Expresses the degree of match between the transmission line and the terminating element (antenna). When VSWR is 1:1 the match is perfect, a VSWR of 1.5:1 corresponds to 96% power efficiency.

### **1.2.3.7 Azimuth 3dB Beamwidth**

Width of the antenna beam on the horizontal plane expressed in degrees.

### **1.2.3.8 Elevation 3dB Beamwidth**

Height of the antenna beam on the vertical plane expressed in degrees.

## **1.3 Antenna Accessories for Enterprise WLANs**

A complete selection of antennas and accessories is available to ensure optimal coverage and performance for wireless LANs. Regardless of the size or layout of your environment, from a small office or storefront to campus-wide, multiple-site, indoor and outdoor deployments, antennas, cables and accessories are available to fit your needs.

By combining this portfolio with a broad line of wireless switches, access ports, access points, client connectivity cards, ruggedized mobile voice/data devices and network management software, as well as wireless mobility planning and deployment services. For more information visit

<https://portal.motorolasolutions.com/Support/US-EN/Wireless+Networks>.

### **1.3.1 Choosing the Right Antenna and accessories for your WLAN**

It is important to consider a number of factors when choosing an antenna and accessories for your Enterprise WLAN. To choose the right components, you'll need to know:

- Where is the antenna to be installed, and what type of coverage is required. Knowing the intended radio band is central. Determine if the intended radio coverage area supports dual 2.4/5.2 band traffic. Has the attenuation of the coverage been discerned in respect to known barriers.
- The band (802.11b/g/n or 802.11a/n) your network supports
- Which AP to use
- Whether you will be deploying the network indoors or outdoors
- The distance between AP and antenna, to determine extender cable length, if any
- The serviceability requirement for each AP and antenna deployment

Review the chart to determine which antennas suit your needs. Using the part numbers provided, determine which of the antennas will work with your hardware in your environment.



# 2

## ***Product Compatibility***

To find the right antenna and accessories for your deployment:

- Find your access point or access port model at the top of the chart (refer to the chart on the following page). Follow that column down to find the antennas, cables and lightning arrestors compatible with that model access port or access point. Write those part numbers down.
- Follow the row antenna across the table to the columns for the lightning arrestors and cables you wrote down to confirm that they compatible with the antenna you've chosen and determine if an adaptor is required to connect the two selected parts.

### **2.1 FCC Compliance**

Enterprise Access Points are approved by the FCC with the understanding that these devices are Professionally Installed. Under FCC regulations, this allows the Professional Installers the flexibility to configure the Access Points for each specific customers needs and insure a compliant installation. The antennas offered in our portfolio have different coverage patterns and antenna gains to meet the needs of different installation requirements and require careful planning. The Access Point transmitter power must be adjusted by the professional installer based on the specific antenna and other installation components used in the installation to ensure compliant operation.

A professional installer must:

- Have a good understanding of RF theory
- Be able to calculate a link budget for a given transmitter configuration. For example, Conducted Output Power + Cabling Losses + Mechanical Connection Losses + Antenna Gain = Output Power (This output power should be equal or lower than the Maximum Power as listed on the FCC Grant for a transmitter)
- Be familiar with both the mechanical and software tools required to configure and adjust the transmitter being installed
- Understand basic FCC regulations for the site specific location and installation requirements of the various radio products being installed
- Understand basic antenna operational theory and standard industry antenna installation practices
- Be certified by local authorities to install electrical devices.



---

**WARNING! OPERATING A TRANSMITTER THAT IS CONFIGURED FOR INDOOR USE IN AN OUTDOOR ENVIRONMENT IS AGAINST FCC REGULATIONS AND SUBJECT TO FCC ENFORCEMENT ACTIONS AGAINST BOTH THE INSTALLER AND THE OPERATOR.**

---

### 2.1.1 Outdoor Access Point Installations

The FCC regulations for the indoor and outdoor installation are different; the professional installer must configure the Access Point transmitters accordingly. Products that are specifically intended to be placed outdoors are configured at the factory for compliant outdoor operation. Professional installers should review the following to assess the legality of outdoor deployments:

- If a transmitter is placed indoors but the antenna is placed outdoors, the FCC interprets this as an outdoor installation
- If a transmitter is placed indoors and the antenna is oriented to intentionally radiate outdoors, the FCC interprets this as an outdoor installation
- If the transmitter is placed on a loading dock or inside a covered stadium with a retractable cover, the FCC views this as an outdoor installation

The *Federal Communications Commission* (FCC), the *National Telecommunications and Information Administration* (NTIA) and the *Federal Aviation Administration* (FAA) have an ongoing investigation of interference caused to *Terminal Doppler Weather Radar* (TDWR) systems operating in the 5600-5650 MHz band. TDWRs are used to detect wind shear and other weather conditions near airports.

The interference at most locations was attributed to fixed wireless transmitters operating outdoors in the vicinity of airports at high elevations that are line-of-sight to the TDWR installations (5 GHz network equipment).

In some instances, the interference was caused by equipment that was not properly certified or configured. In other instances, equipment was FCC certified nonetheless caused interference. The FCC has taken appropriate enforcement action in each of these cases.

If everything is determined to be compliant - the FCC orders the interfering transmitter turned off or adjustments be made such that there is no more interference; any non-compliance determined is resolved with an enforcement action.

On 14 OCTOBER 2010 the FCC published the following notice that requests that devices operating in the 5.4 GHz band located near the appended list of airports register these devices. A voluntary WISPA sponsored database has been developed that allows operators and installers to register the location information of the UNII devices operating outdoors in the 5470 - 5725 MHz band within 35 km of any TDWR location.



**NOTE:** The voluntary registration of all outdoor installations is strongly encouraged at <http://www.spectrumbridge.com/udia/home.aspx>.

---

## 2.2 FCC Approval Statement

**Federal Communications Commission  
Office of Engineering and Technology  
Laboratory Division**

### **Interim Plans to Approve UNII Devices Operating in the 5470 - 5725 MHz Band with Radar Detection and DFS Capabilities**

The FCC, NTIA, FAA and industry are working to resolve interference to Terminal Doppler Weather Radar (TDWR) systems used near airports that has occurred from some outdoor wireless systems operating in the 5470 MHz – 5725 MHz band. These wireless devices are subject to Section 15.407 of our rules and when operating as a master device they are required to implement radar detection and DFS functions. We are continuing our work to develop long-term equipment authorization test procedures that will ensure that the devices comply with our rules that include protecting the TDWR operations. In the interim, the Commission will now allow certification of wireless master devices with radar detection function and with DFS capability, if they meet the following conditions:

- Devices will not transmit on channels which overlap the 5600 – 5650 MHz band.<sup>1</sup>
- Devices intended for outdoor use will be further restricted, as follows:
  - Devices must be professionally installed when operating in the 5470 – 5725 MHz band.<sup>2</sup>
  - Grantees must provide owners, operators and all such installers with specific instructions in their user's manual on requirements to avoid interference to TDWRs and information that meets the following instructions:
    - Any installation of either a master or a client device within 35 km of a TDWR location shall be separated by at least 30 MHz (center-to-center) from the TDWR operating frequency (as shown in the attached table)<sup>3, 4, and 5</sup>.

<sup>1</sup> The devices subject to the requirements in this KDB can select the initial channel for operation to avoid TDWRs and apply the Uniform Channel Spreading requirements (see FCC 06-96 in ET Docket 03-122 released June 30, 2006) on the remaining available frequency band of operation. All the other test procedures including the test radar patterns remain the same at the present time. A revision to the measurement procedure with modification to the Uniform Channel Spreading requirement and other changes will be released in the future. The Commission will also address the issue of any field upgrade option at that time.

<sup>2</sup> The grantee must identify the specific expertise and the training required by the installers for installing these types of devices.

<sup>3</sup> In some instances it is possible that a device may be within 35 km of multiple TDWRs. In this case the device must ensure that it avoids operation within 30 MHz for each of the TDWRs. This requirement applies even if the master is outside the 35 km radius but communicates with outdoor clients which may be within the 35 km radius of the TDWRs.

<sup>4</sup> The requirement for ensuring 30 MHz frequency separation is based on the best information available to date. If interference is not eliminated, a distance limitation based on line-of-sight from TDWR will need to be used. In addition, devices with bandwidths greater than 20 MHz may require greater frequency separation.

- Procedures for the installers and the operators on how to register the devices in the industry-sponsored database with the appropriate information regarding the location and operation of the device and installer information is included.<sup>6</sup>
- Devices must meet all of the other requirements specified in Section 15.407, and it is prohibited to include configuration controls (e.g. country code settings or other options to modify DFS functions) to change the frequency of operations to any frequency other than those specified on the grant of certification for US operation.<sup>7</sup>

- All applications for equipment authorization must clearly show compliance with all of the technical requirements under worst case parameters, under user or operator control, based on frame rates, listen/talk ratios and user data transfer conditions.

All the devices subject to the DFS requirements must be submitted to the Commission's Laboratory Division for pre-grant testing and equipment authorization.<sup>8</sup> The applicant must ensure that all equipment authorization applications subject to this interim procedure include appropriate attestations that the device has no option to change the DFS parameters and that transmissions are disabled at least in the 5600 – 5650 MHz band. The application must include the user's manual with the appropriate installation and operations requirements for the installers and operators.

We are continuing to evaluate additional measures that may need to be taken to further ensure against interference caused by 5 GHz outdoor wireless systems located near airports. While manufacturers have an obligation to ensure that their equipment complies with FCC rules, and must take steps to ensure their devices are unlikely to cause harmful interference, Section 15.5 of the Commission's rules also places an obligation on users of devices to avoid causing interference and to correct any interference that may occur. We encourage the manufacturers to include information for the users, including the operators and installers, to ensure that they understand that it is incumbent on them to cooperate with manufacturers to implement any changes necessary to facilitate compliance.

<sup>5</sup> Devices may be optionally designed not to transmit on channels which overlap 5570 – 5680 MHz instead of requiring installers to perform site-by-site adjustments. In that case it is still required that the devices should be installed professionally and the procedures for registering the device in the industry database should be included in the Users Manual.

<sup>6</sup> A voluntary WISPA sponsored database has been developed that allows operators and installers to register the location information of the UNII devices operating outdoors in the 5470 – 5725 MHz band within 35 km of any TDWR location (see <http://www.spectrumbridge.com/udia/home.aspx>). This database may be used by government agencies in order to expedite resolution of any interference to TDWRs.

<sup>7</sup> For example, device software must not have any country code options or software configuration settings which allow an end user to modify the DFS operation or impact the performance of DFS. See KDB 594280.

<sup>8</sup> The TCBs are not permitted to approve transmitters with radar detection capabilities. See KDB 628591.

<sup>9</sup> The manufacturers may consider taking steps providing clear instructions to operators and installers of devices as to the need to comply with rules for use of the band, guidance on registration of devices and any other processes that are designed to avoid interference. They may use methods that include, but are not limited to, instructions in manuals, notification on product web pages and service bulletins issued for products in the field.

#### **TDWR Location Information\***

<b>STATE</b>	<b>CITY</b>	<b>LONGITUDE</b>	<b>LATITUDE</b>	<b>FREQUENCY</b>	<b>TERRAIN ELEVATION (MSL) [ft]</b>	<b>ANTENNA HEIGHT ABOVE TERRAIN [ft]</b>
AZ	PHOENIX	W 112 09 46	N 33 25 14	5610 MHz	1024	64
CO	DENVER	W 104 31 35	N 39 43 39	5615 MHz	5643	64
FL	FT LAUDERDALE	W 080 20 39	N 26 08 36	5645 MHz	7	113
FL	MIAMI	W 080 29 28	N 25 45 27	5605 MHz	10	113
FL	ORLANDO	W 081 19 33	N 28 20 37	5640 MHz	72	97
FL	TAMPA	W 082 31 04	N 27 51 35	5620 MHz	14	80
FL	WEST PALM BEACH	W 080 16 23	N 26 41 17	5615 MHz	20	113

<b>STATE</b>	<b>CITY</b>	<b>LONGITUDE</b>	<b>LATITUDE</b>	<b>FREQUENCY</b>	<b>TERRAIN ELEVATION (MSL) [ft]</b>	<b>ANTENNA HEIGHT ABOVE TERRAIN [ft]</b>
GS	ATLANTA	W 084 15 44	N 33 38 48	5615 MHz	962	113
IL	MCCOOK	W 087 51 31	N 41 47 50	5615 MHz	646	97
IL	CRESTWOOD	W 087 43 47	N 41 39 05	5645 MHz	663	113
IN	INDIANAPOLIS	W 086 26 08	N 39 38 14	5605 MHz	751	97
KS	WICHITA	W 097 26 13	N 37 30 26	5603 MHz	1270	80
KY	COVINGTON CINNCINNATI	W 084 34 48	N 38 53 53	5610 MHz	942	97
KY	LOUISVILLE	W 085 36 38	N 38 02 45	5646 MHz	617	113
LA	NEW ORLEANS	W 090 24 11	N 30 01 18	5645 MHz	2	97
MA	BOSTON	W 070 56 01	N 42 09 30	5610 MHz	151	113
MD	BRANYWINE	W 076 50 42	N 38 41 43	5635 MHz	233	113
MD	BENFIELD	W 076 37 48	N 39 05 23	5645 MHz	184	113
MD	CLINTON	W 076 57 43	N 38 45 32	5615 MHz	249	97
MI	DETROIT	W 083 30 54	N 42 06 40	5615 MHz	656	113
MN	MINNEAPOLIS	W 092 55 58	N 44 52 17	5610 MHz	1040	80
MO	KANSAS CITY	W 094 44 31	N 39 29 55	5605 MHz	1040	64
MO	SAINT LOUIS	W 090 29 21	N 38 48 20	5610 MHz	551	97
MS	DESOTO COUNTY	W 089 59 33	N 34 53 45	5610 MHz	371	113
NC	CHARLOTTE	W 080 53 06	N 35 20 14	5608 MHz	757	113
NC	RALEIGH DURHAM	W 078 41 50	N 36 00 07	5647 MHz	400	113
NJ	WOODBIDGE	W 074 16 13	N 40 35 37	5620 MHz	19	113
NJ	PENNSAUKEN	W 075 04 12	N 39 56 57	5610 MHz	39	113
NV	LAS VEGAS	W 115 00 26	N 36 08 37	5645 MHz	1995	64
NY	FLOYDBENNETT FIELD	W 073 52 49	N 40 35 20	5647 MHz	8	97
OH	DAYTON	W 084 07 23	N 40 01 19	5640 MHz	922	97
OH	CLEVELAND	W 082 00 28	N 41 17 23	5645 MHz	817	113
OH	COLUMBUS	W 082 42 55	N 40 00 20	5605 MHz	1037	113
OK	AERO. CTR TDWR #1	W 097 37 31	N 35 24 19	5610 MHz	1285	80

STATE	CITY	LONGITUDE	LATITUDE	FREQUENCY	TERRAIN ELEVATION (MSL) [ft]	ANTENNA HEIGHT ABOVE TERRAIN [ft]
OK	AERO. CTR TDWR #2	W 097 37 43	N 35 23 34	5620 MHz	1293	97
OK	TULSA	W 095 49 34	N 36 04 14	5605 MHz	712	113
OK	OKLAHOMA CITY	W 097 30 36	N 35 16 34	5603 MHz	1195	64
PA	HANOVER	W 080 29 10	N 40 30 05	5615 MHz	1266	113
PR	SAN JUAN	W 066 10 46	N 18 28 26	5610 MHz	59	113
TN	NASHVILLE	W 086 39 42	N 35 58 47	5605 MHz	722	97
TX	HOUSTON INTERCONTL	W 095 34 01	N 30 03 54	5605 MHz	154	97
TX	PEARLAND	W 095 14 30	N 29 30 59	5645 MHz	36	80
TX	DALLAS LOVE FIELD	W 096 58 06	N 32 55 33	5608 MHz	541	80
TX	LEWISVILLE DFW	W 096 55 05	N 33 03 53	5640 MHz	554	31
UT	SALT LAKE CITY	W 111 55 47	N 40 58 02	5610 MHz	4219	80
VA	LEESBURG	W 077 31 46	N 39 05 02	5605 MHz	361	113
WI	MILWAUKEE	W 088 02 47	N 42 49 10	5603 MHz	820	113

## 2.3 FCC USA Compatibility Matrix

The following (on the next two pages) displays FCC approved AP radio, antenna, cable and accessory combinations for use in the United States for both current and legacy access points:

		AP Radios										Cables					LAs					
		AP-7131 ABGN (U77AP7131)	AP-7131N AGBN (U77AP7131N)	AP-650/6532 (U77MB82)	AP-621/6521 (U77AP6)	AP-7161 (QJAP716101)	AP-622/6522 (U77AP0622)	AP-6562 (U77AP0622)	AP-8132 (U77KHAP800)	AP-8163 (U77KHAP800)	AP-8232 (U77RAAP800)	AP-7522 (U77AP7522)	AP-7532 (U77AP7532)	AP-7562 (H9PAP7562)	ML-1499-100JK-01R	ML-1499-10JK-01R	ML-1499-25JK-01R	ML-1499-50JK-01R	ML-1499-72PJ-01R	ML-1499-LAK1-01R	ML-1499-LAK2-01R	ML-2452-LAK1-01R
2.4 GHz	ML-2499-FHPA5-01R	7	7	7	X	*	7	*	7	*	7	X	X	*	A	A	A	A	X	*	*	*
	ML-2499-HPA3-02R	X	X	*	*	5	*	5	*	5	*	X	X	X	4	4	4	4	X	5	5	5
	ML-2499-HPA4-01	X	7	7	7	*	7	*	7	*	7	X	X	*	A	A	A	A	X	*	*	*
	ML-2499-HPA8-01	X	X	7	X	*	7	*	7	*	7	X	X	X	A	A	A	A	X	*	*	*
	ML-2499-PNAHD-02R	*	*	*	X	X	*	5	*	5	*	5	X	X	4	4	4	4	X	5	5	5
5 GHz	ML-5299-FHPA6-01R	7	7	7	X	*	7	*	7	*	7	X	X	X	A	A	A	A	X	*	*	*
	ML-5299-HPA1-01R	*	*	*	*	5	*	5	*	5	*	X	X	X	4	4	4	4	X	5	5	5
	ML-5299-HPA5-01	X	7	7	7	*	7	*	7	*	7	X	X	X	A	A	A	A	X	*	*	*
	ML-5299-HPA10-01	X	X	7	X	*	X	*	7	*	7	X	X	X	A	A	A	A	X	*	*	*
Dual-Band	ML-2452-APA2-01	*	*	*	*	X	*	X	*	X	*	*	*	X	X	X	X	X	X	X	X	X
	ML-2452-APA2-02	*	*	*	*	X	*	X	*	X	*	*	*	X	X	X	X	X	X	X	X	X
	ML-2452-APAG2A1-01	X	X	X	*	X	*	X	*	X	*	*	*	X	X	X	X	X	X	X	X	X
	ML-2452-APAG2A1-02	X	X	X	*	X	*	X	*	X	*	*	*	X	X	X	X	X	X	X	X	X
	ML-2452-HPA5-036	*	*	*	*	5	*	5	*	5	*	*	*	X								
	ML-2452-HPA6-01	X	X	*	X	*	7	*	*	*	X	X	X	*								
	ML-2452-HPA6M6-072	X	X	*	X	5	X	X	*	5	*	X	X	X								
	ML-2452-HPA6X6-036	X	7	7	7	*	7	*	7	*	7	X	X	*	A	A	A	A	X	*	*	*
	ML-2452-HPAG4A6-01	X	X	*	*	*	*	*	7	*	7	X	X	*	A	A	A	A	X	*	*	*
	ML-2452-HPAG5A8-01	X	X	*	X	*	*	*	7	*	7	X	X	X	A	A	A	A	X	*	*	*
	ML-2452-PNA5-01R	7	7	7	X	7	*	7	*	7	*	7	7	7	A	A	A	A	X			
	ML-2452-PNA7-01R	7	7	X	X	X	7	*	7	*	7	X	X	X	A	A	A	A	X			
	ML-2452-PNL9M3-036	*	*	X	X	X	*	5	*	5	*	X	X	X								
	ML-2452-PTA2M2-036	X	*	*	*	X	*	X	X	X	X	X	X	X	4	4	4	4	X	5	5	5
	ML-2452-PTA2M3X3-1	*	*	X	X	X	X	X	X	X	X	X	X	X								
	ML-2452-PTA3M3-036	X	*	*	*	X	*	X	X	X	X	X	X	X								
	ML-2452-PTA6M6-1	X	X	X	X	X	X	X	*	X	*	X	X	X								
	ML-2452-PTA6M6-036	X	X	X	X	X	X	X	*	X	*	X	X	X								
	ML-2452-PTA6X6-036	*	*	*	*	X	*	X	X	X	X	X	X	X	4	4	4	4	X	5	5	5
	ML-2452-PNL3M3-1	X	X	X	X	*	X	X	X	*	X	X	X	*								
ML-2452-PNL6M3-N36	X	X	X	X	*	X	X	X	*	X	X	X	*									
ML-2452-PNL9M3-N36	7	7	X	X	*	X	X	7	*	7	X	X	X									
ML-2452-SEC6M3-N36	X	X	X	X	*	X	X	X	*	X	X	X	*									
ML-2452-VMM3M3-036	X	X	X	X	5	X	X	X	*	X	X	X	*	4	4	4	4	X	5	5	5	
ML-2452-VMM5M3-N72	X	X	X	X	*	X	X	X	*	X	X	X	*									
LAs	ML-1499-LAK1-01R	X	X	X	X	X	X	X	X	X	X	X	X	X	*	*	*	*	X			
	ML-1499-LAK2-01R	X	X	X	X	*	X	*	X	*	X	X	X	*	*	*	*	X				
	ML-2452-LAK1-01R	*	*	*	*	X	*	X	*	X	*	*	*	X	*	*	*	*	X			
Cables	ML-1499-100JK-01R	7	7	7	7	*	7	*	7	*	7	7	7	*								
	ML-1499-10JK-01R	7	7	7	7	*	7	*	7	*	7	7	7	*								
	ML-1499-25JK-01R	7	7	7	7	*	7	*	7	*	7	7	7	*								
	ML-1499-50JK-01R	7	7	7	7	*	7	*	7	*	7	7	7	*								
	ML-1499-72PJ-01R	X	X	X	X	X	X	X	X	X	X	X	X	X								

Key	Adapter P/N	Adapter Description
1	ML-1499-RBNCA1-01R	RP-BNC-F to N-F
2	ML-1499-RBNCA2-01R	RP-BNC-F to N-M
3	25-72178-01	RP-SMA-M to RP-BNC-F
4	25-90262-01R	RP-SMA-F to N-F
5	25-90263-01R	RP-SMA-F to N-M
6	25-85391-01R	RP-SMA-M to N-M
7	25-85392-01R	RP-SMA-M to N-F
8	must use ML-1499-LAK1-01R	
9	25-97261-01R	N-M to RP-BNC-M
A	25-99175-01R	N-F to N-F

Key	Description
*	Compatible
X	Not compatible
	Not required
	Outdoor rated





## ***2.4 GHz Single Band Antenna Suite***

### **3.1 Supported 802.11b/g/n Antenna Suite**

Numerous single-band 2.4 GHz 802.11b/g/n antennas are supported to suit the requirements of your unique access point or access port deployment. Check the Support site periodically, as newly supported 802.11b/g/n antennas will be added to this document as they are released.

For detailed information on supported 802.11b/g/n antenna models, refer to:

- *ML-2499-HPA3-02R Dipole Omni Antenna: RP-SMA Male*
- *ML-2499-FHPA5-01R Omni-Directional "Pipe" Antenna: N Male Connector*
- *ML-2499-HPA8-01 Outdoor Dipole Omni Antenna: N Male Connector*
- *RAN405A-01R 802.11BGN, Dipole Omni, DT, 7dBi, LP, N-Type-M*

### 3.1.1 ML-2499-HPA3-02R Dipole Omni Antenna: RP-SMA Male

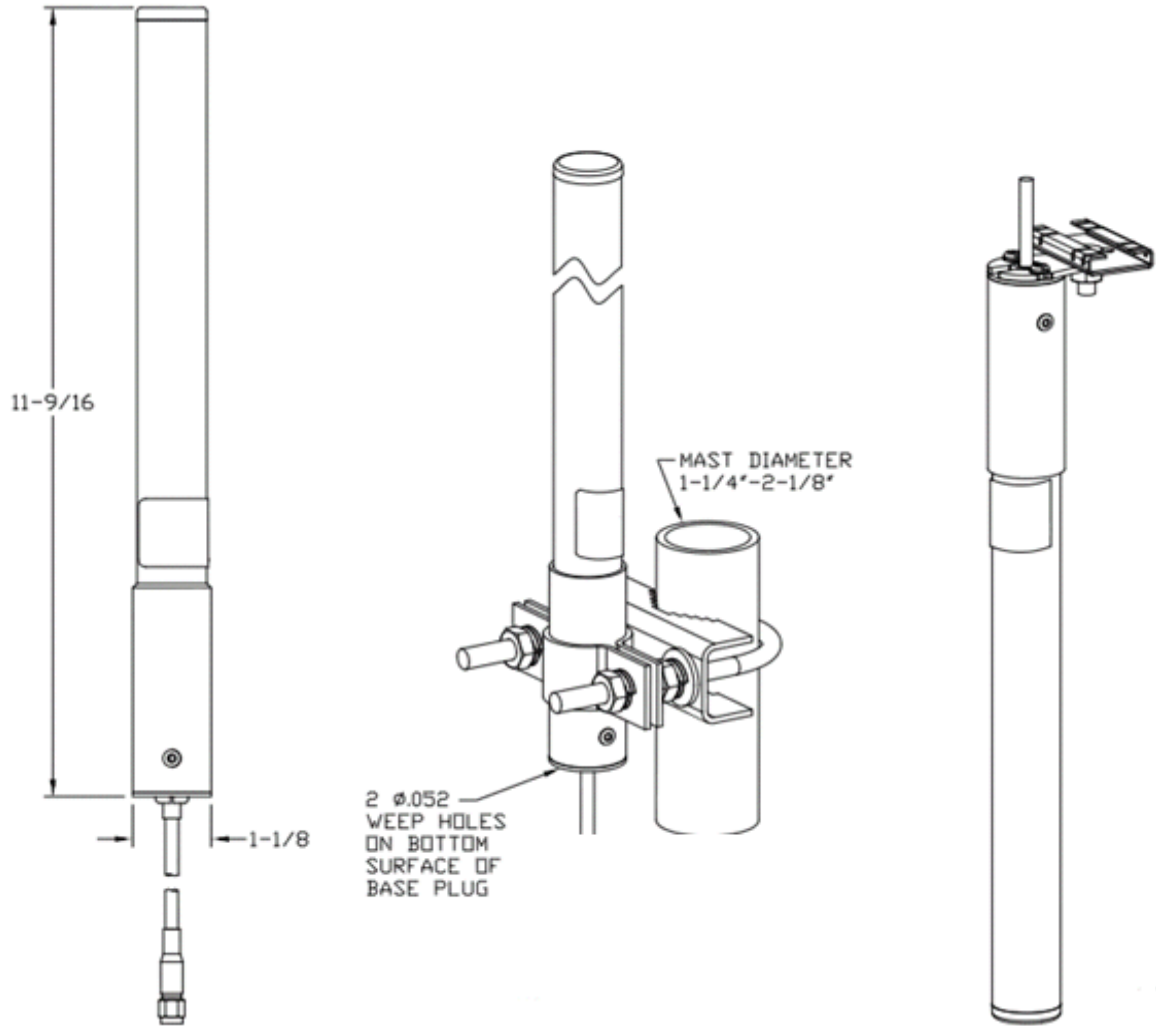

Type	Dipole Omni
Frequency	2400-2500 MHz
Max/Typical Gain (dBi)	5.0/3.0
Polarization	Linear, Vertical
Azimuth	3dB Beamwidth: 360°
Elevation	3dB Beamwidth: 32°
Cable Length (in.)	48
Cable Type	RG-58 Ultralink
Connector Type	RP-SMA Male
Weight	0.3 lbs
Plenum Antenna	No

Plenum Cable	Yes
Outdoor Rated	Yes (in a cable down orientation)
Storage Temp Range (C)	-30 / +70
Operation Temp Range (C)	-30 / +70

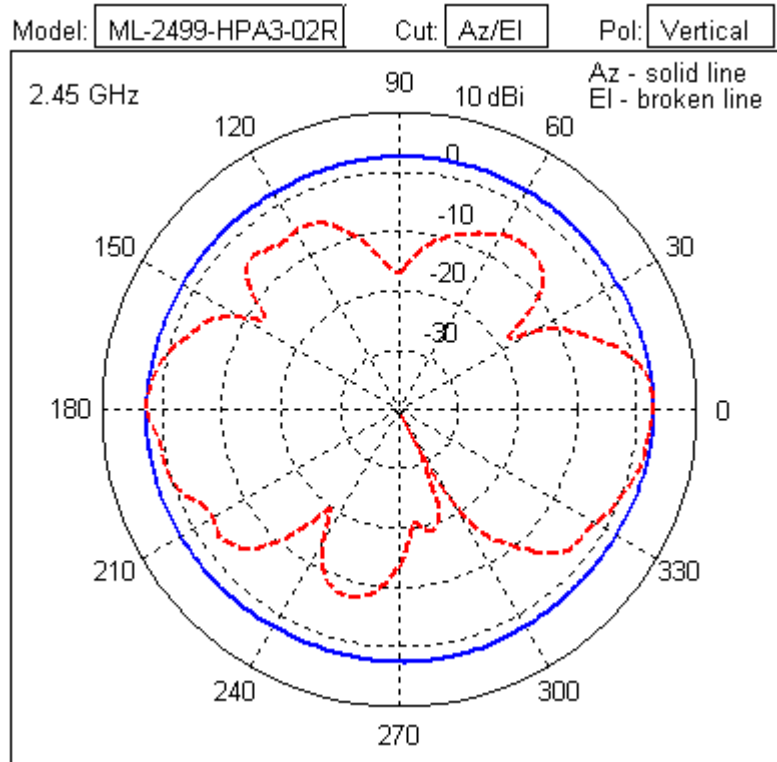

### 3.1.2 ML-2499-FHPA5-01R Omni-Directional "Pipe" Antenna: N Male Connector

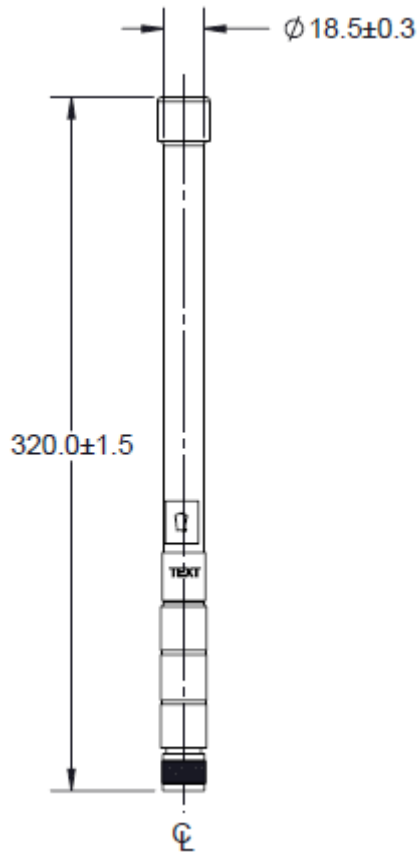

Type	Dipole Omni
Frequency	2400-2500 MHz
Gain (dBi)	5
Polarization	Linear, Vertical
Azimuth	3dB Beamwidth: 360°
Elevation	3dB Beamwidth: 25°
Cable Length (in.)	N/A
Cable Type	N/A
Connector Type	Type N Male
Weight	0.7 lbs
Plenum Antenna	No
Plenum Cable	N/A
Outdoor Rated	Yes
Storage Temp Range (C)	-40 / +85

Operation Temp Range (C)	-30 / +70
--------------------------	-----------

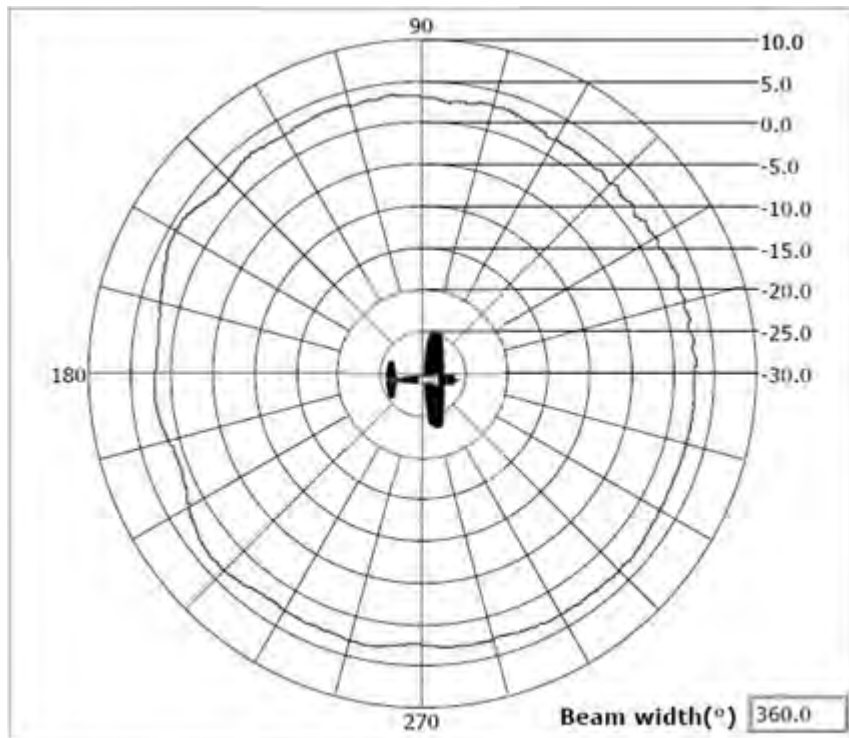

**Azimuth Pattern 2450 MHz**

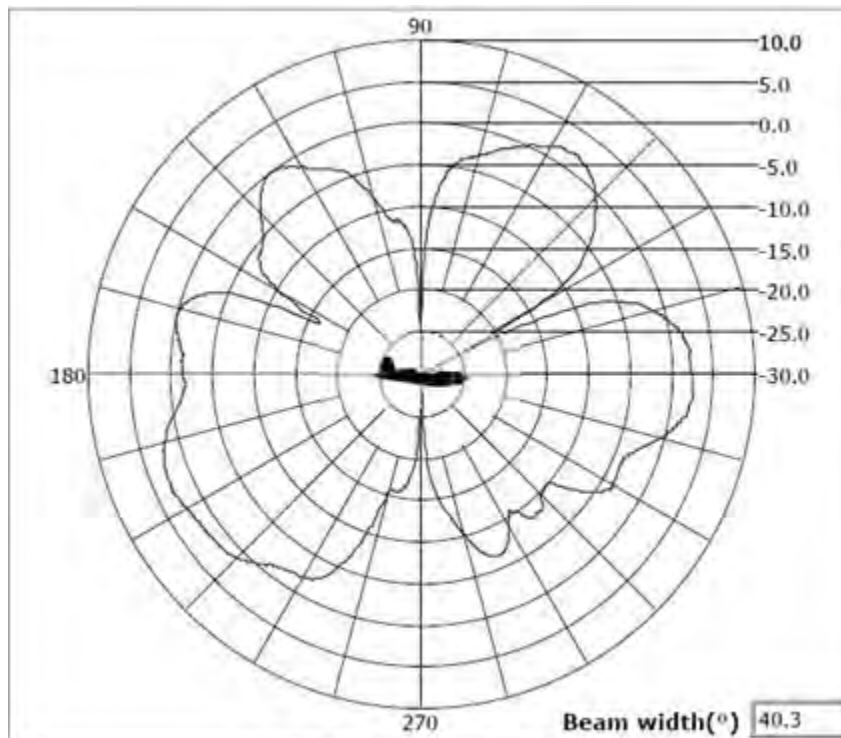

**Elevation Pattern 2450 MHz**

### 3.1.3 ML-2499-HPA8-01 Outdoor Dipole Omni Antenna: N Male Connector

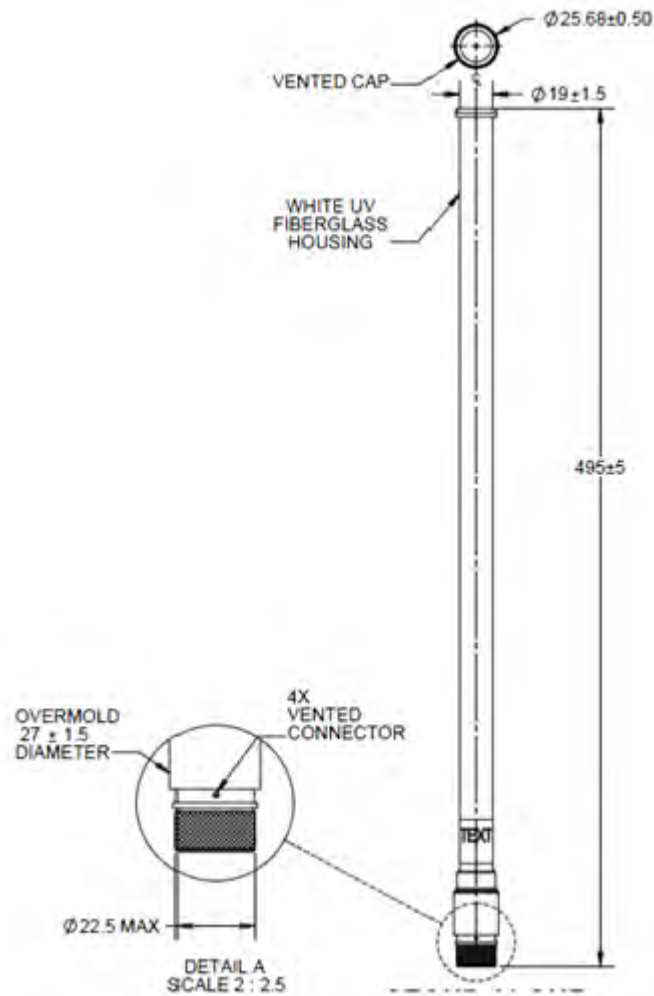

Type	Dipole, Omni
Frequency	2400-2500 MHz
Max/Typical Gain (dBi)	8.0/7.0
Polarization	Linear, Vertical
Azimuth	3dB Beamwidth: 360°
Elevation	3dB Beamwidth: 14°
Cable Length (in.)	n/a
Cable Type	n/a
Connector Type	N-Type Male
Weight	0.45 lbs
Plenum Antenna	No

Plenum Cable	n/a
Outdoor Rated	Yes
Storage Temperature Range (C)	-40 / +85
Operation Temperature Range (C)	-30 / +70

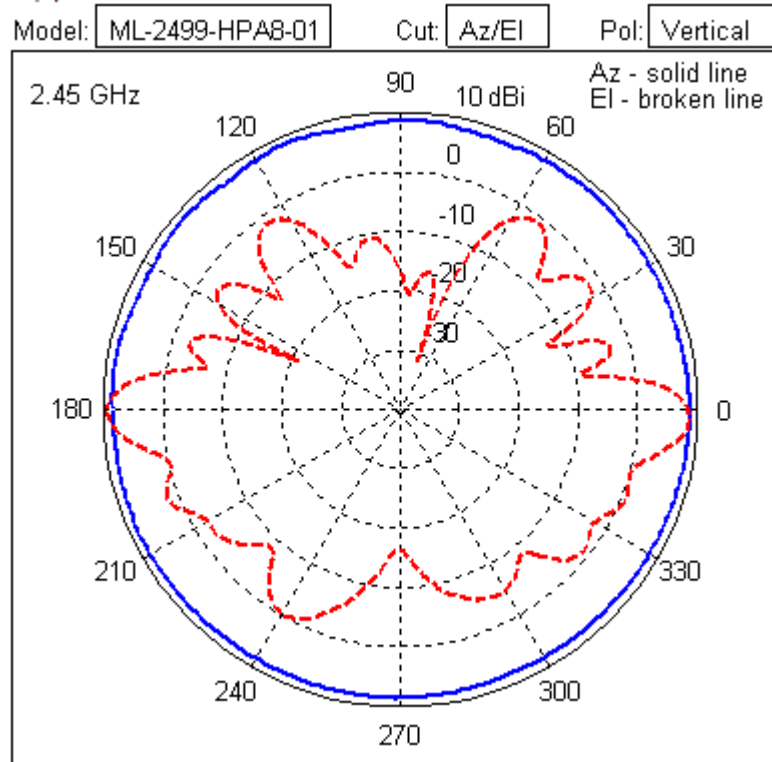

### 3.1.4 RAN405A-01R 802.11BGN, Dipole Omni, DT, 7dBi, LP, N-Type-M

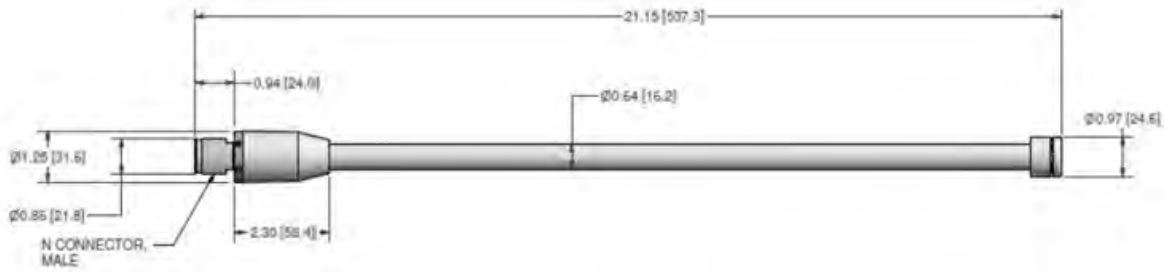

Type	Dipole, Omni
Frequency	2400-2500 MHz
Max/Typical Gain (dBi)	7.15/ 7.0
Polarization	Vertical
Azimuth	3dB Beamwidth: 360°
Elevation	3dB Beamwidth: 14°
Cable Length (in.)	n/a
Cable Type	n/a
Connector Type	N-Type Male, Fixed
Weight	0.5 lbs
Plenum Antenna	No
Plenum Cable	No
Outdoor Rated	Yes
Storage Temperature Range (C)	-45/ +70
Operation Temperature Range (C)	-40 / +70



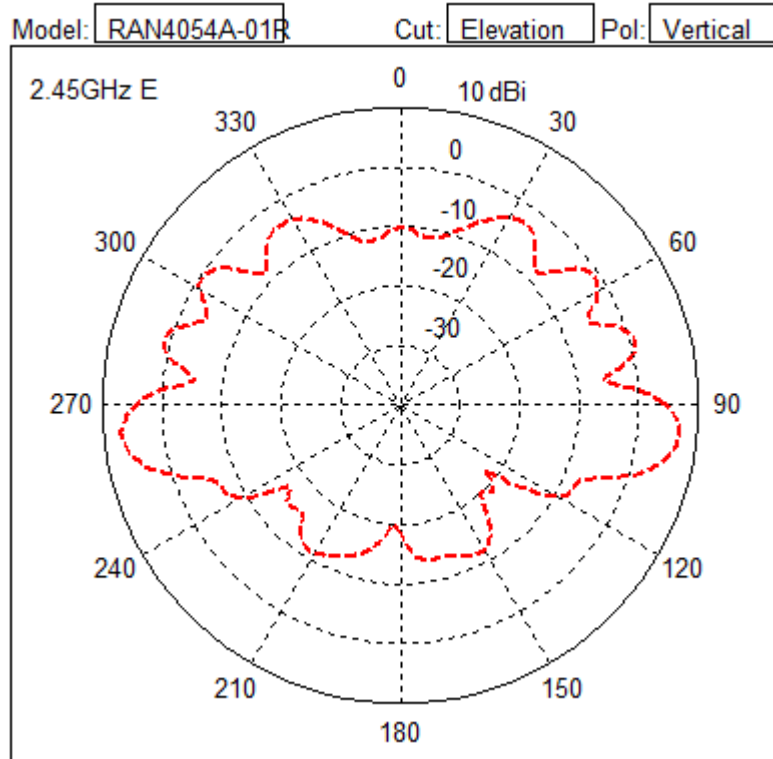
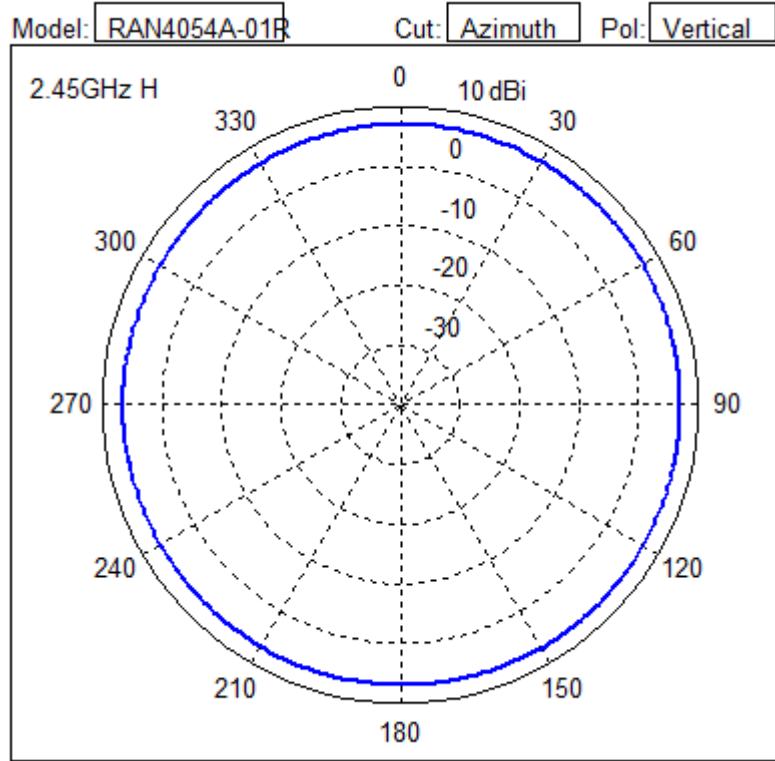



## ***5.2 Ghz Single Band Antenna Suite***

### **4.1 Supported 802.11a/n Antenna Suite**

Numerous 802.11a/n antennas are supported to suit the requirements of your unique access point deployment. Check the Support site periodically, as newly supported 802.11a/n antennas will be added to this document as they are released.

For detailed information on supported 802.11a/n antenna models, refer to:

- *[ML-5299-APA1-01R Indoor Rubber Flex Jointed Dipole: RP-SMA Male Connector](#)*
- *[ML-5299-FHPA6-01R Omni-Directional "Pipe" Antenna: N-Male Connector](#)*
- *[ML-5299-HPA5-01 Outdoor Dipole Omni N-Male](#)*
- *[ML-5299-HPA10-01 Outdoor Dipole Omni N-Male](#)*

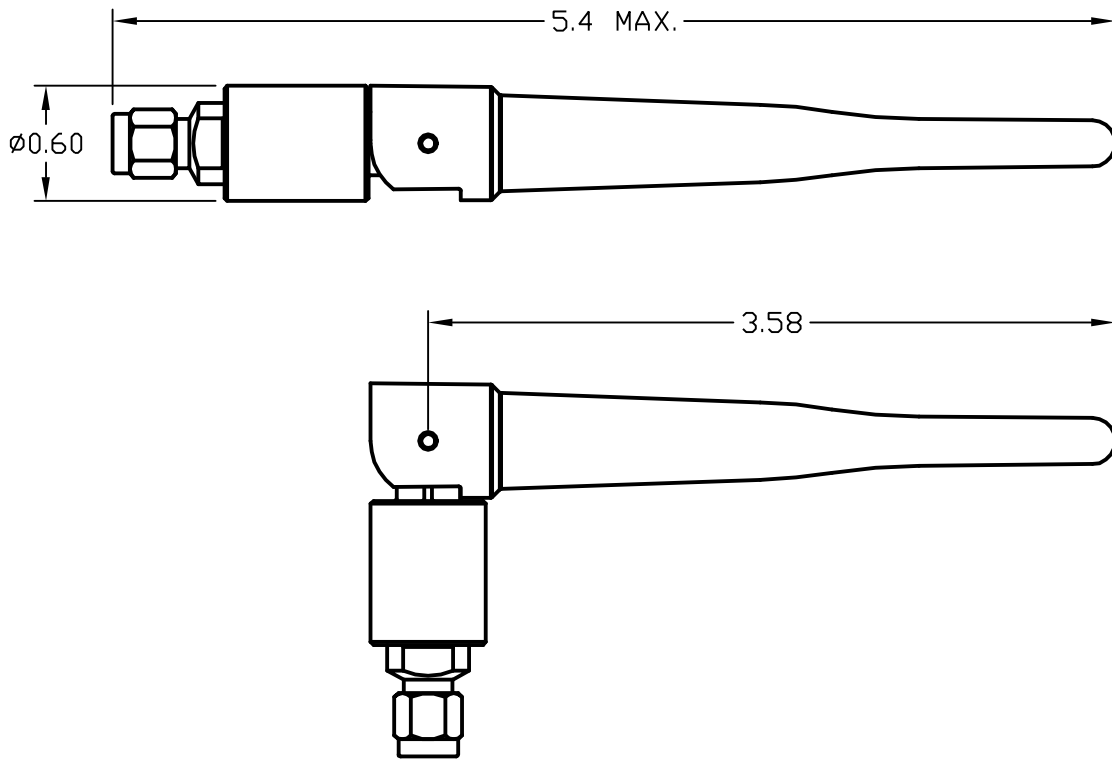
**4.1.1 ML-5299-APA1-01R Indoor Rubber Flex Jointed Dipole: RP-SMA Male Connector**

Type	Dipole
Frequency	5150-5350, 5725-5875
Max/Typical Gain (dBi)	4.0/3.0
Polarization	Linear, Vertical
Azimuth	3dB Beamwidth: 360°
Elevation	3dB Beamwidth: 60°
Cable Length (in.)	N/A
Cable Type	N/A
Connector Type	RP-SMA Male
Weight	0.3 lb
Plenum Antenna	No
Plenum Cable	N/A
Outdoor Rated	No
Storage Temp Range (C)	-30 / +85
Operation Temp Range (C)	-20 / +75

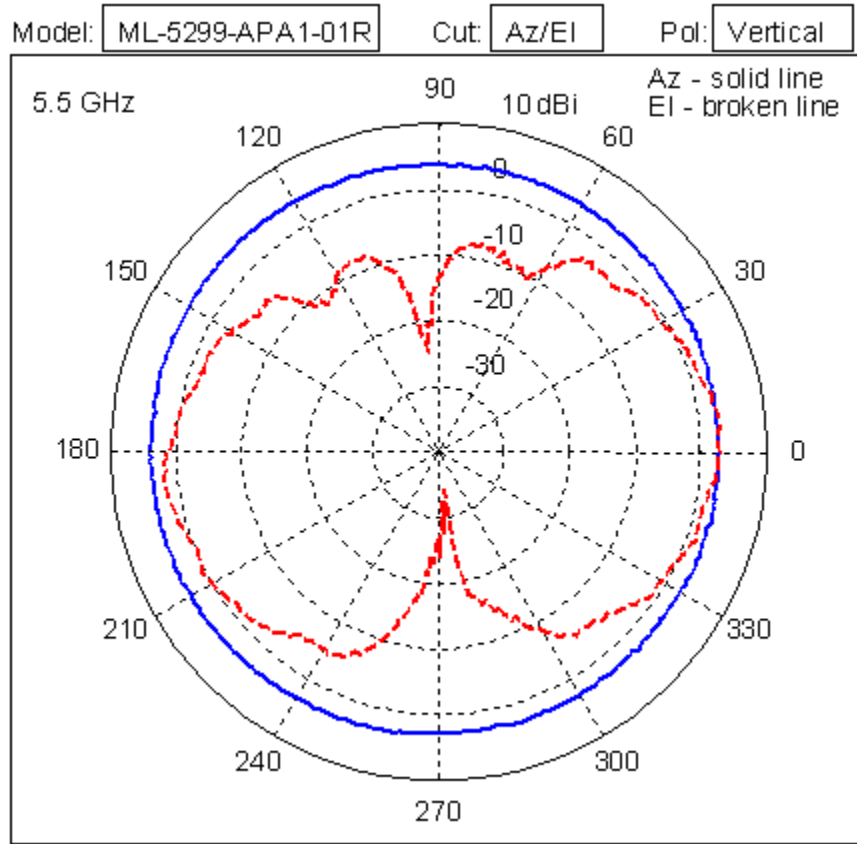

### 4.1.2 ML-5299-FHPA6-01R Omni-Directional "Pipe" Antenna: N-Male Connector

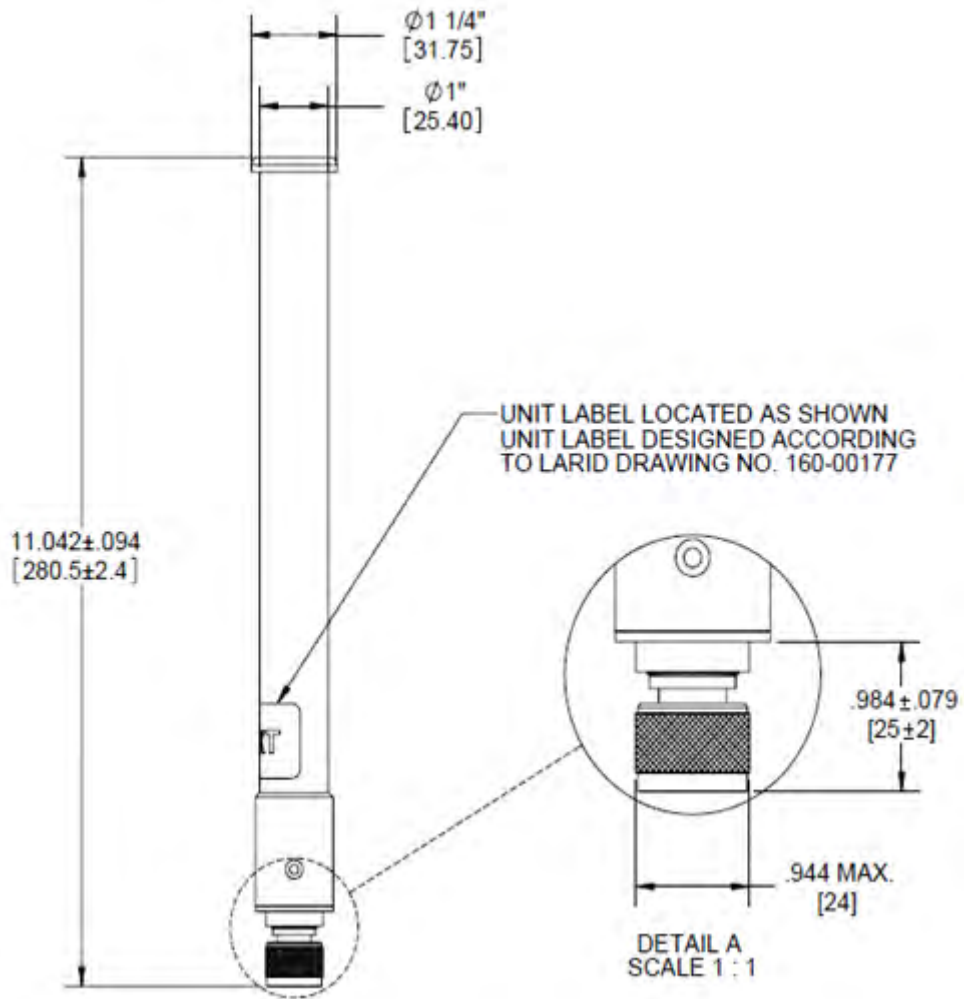

Type	Dipole Array
Frequency	4900-5875
Max/Typical Gain (dBi)	8.25/7.5
Polarization	Linear, Vertical
Azimuth	3dB Beamwidth: 360°
Elevation	3dB Beamwidth: 16°
Cable Length (in.)	N/A
Cable Type	N/A
Connector Type	Type N Male
Weight	0.37 lb
Plenum Antenna	No
Plenum Cable	N/A
Outdoor Rated	Yes

Storage Temp Range (C)	-40 / +85
Operation Temp Range (C)	-30 / +70

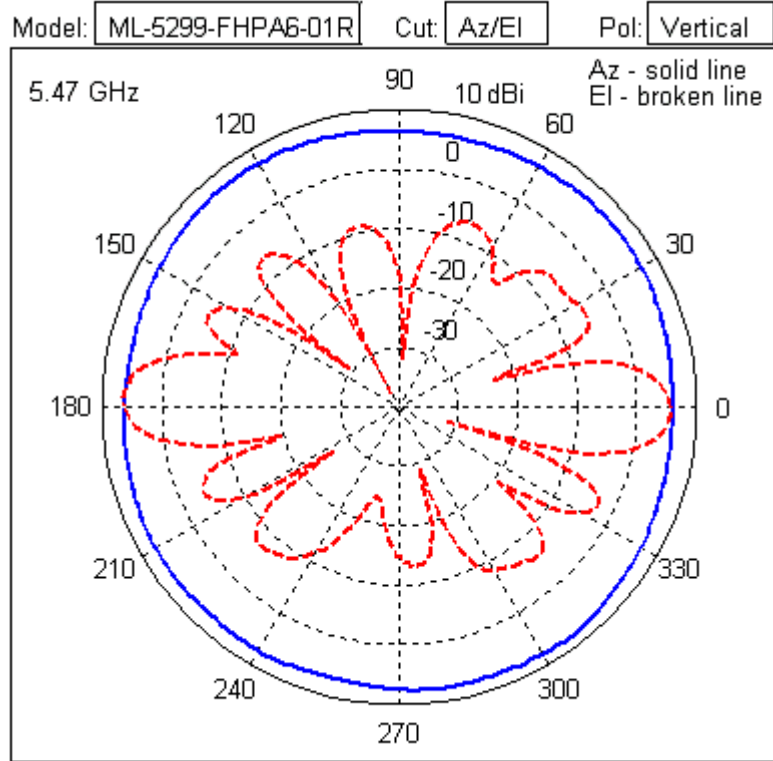

### 4.1.3 ML-5299-HPA5-01 Outdoor Dipole Omni N-Male

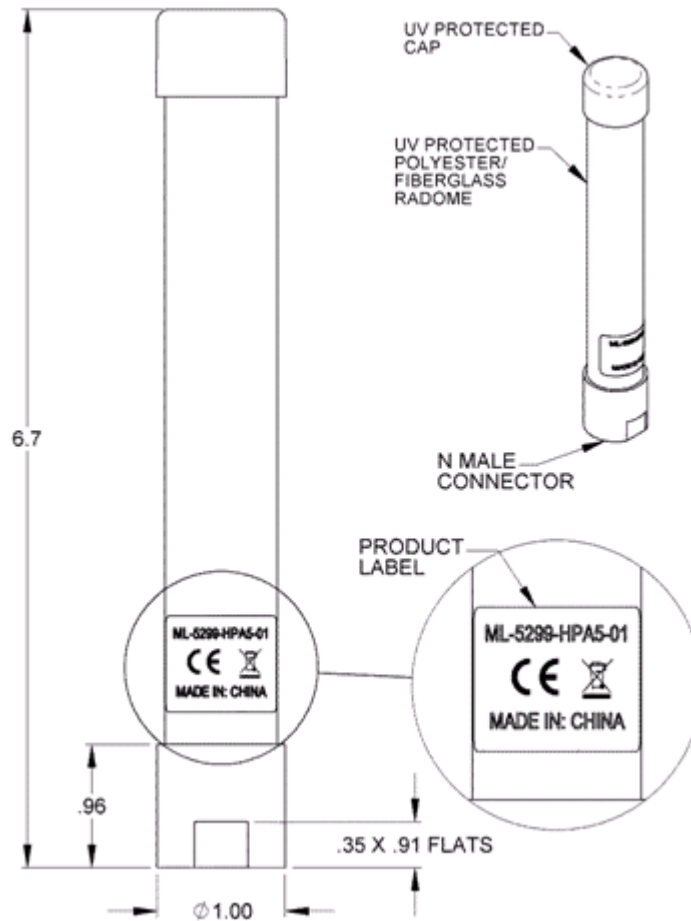

Type	Dipole Omni
Frequency	5150-5850
Max/Typical Gain (dBi)	5.6/4.4
Elevation Gain (dBi)	-2.5
Polarization	Linear, Vertical
Azimuth	3dB Beamwidth: 360°
Elevation	3dB Beamwidth: 22°
Cable Length (in.)	n/a
Cable Type	n/a
Connector Type	N-Type Male
Weight	73.8 grams
Plenum Antenna	No



Plenum Cable	n/a
Outdoor Rated	Yes
Storage Temp Range (C)	-40 / +85
Operation Temp Range (C)	-40 / +85

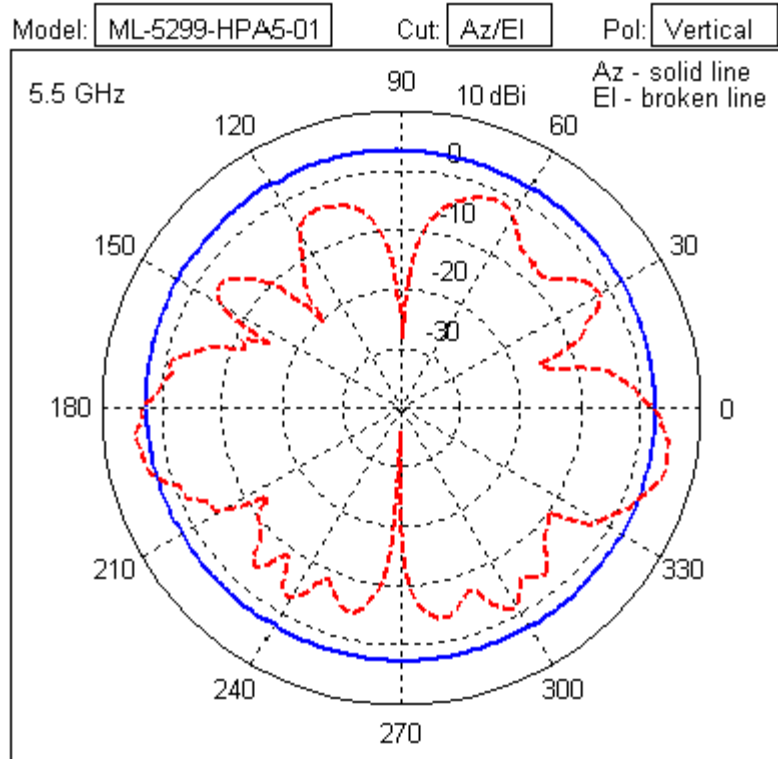

### 4.1.4 ML-5299-HPA10-01 Outdoor Dipole Omni N-Male

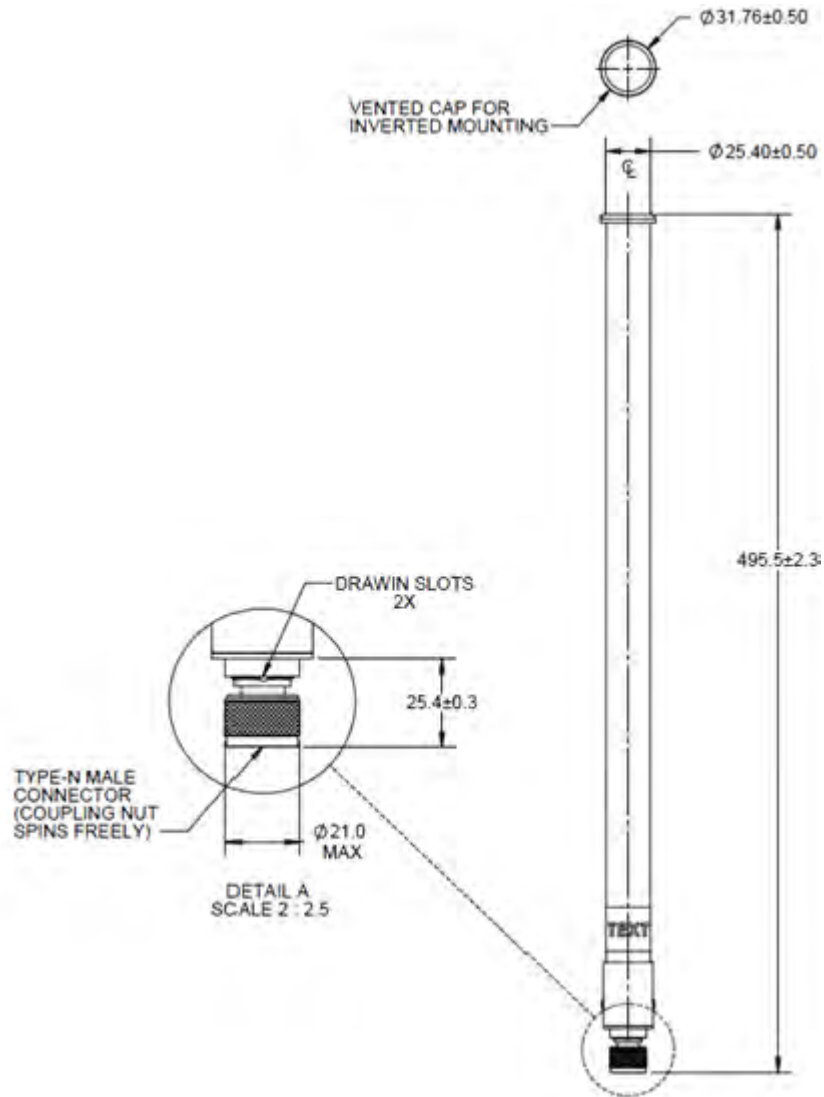

Type	Dipole Omni
Frequency	4900-5875
Gain (dBi)	10.5
Polarization	Linear, Vertical
Azimuth	3dB Beamwidth: 360°
Elevation	3dB Beamwidth: 8°
Cable Length (in.)	n/a
Cable Type	n/a
Connector Type	N-Type Male
Weight	0.4 lbs
Plenum Antenna	No

Plenum Cable	n/a
Outdoor Rated	Yes
Storage Temp Range (C)	-40 / +85
Operation Temp Range (C)	-30 / +70

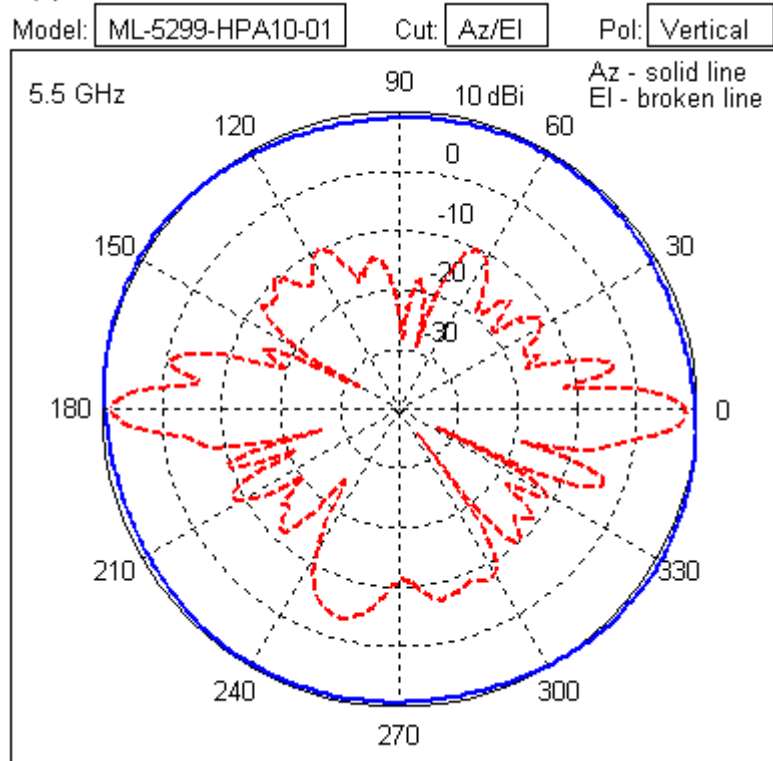



## 2.4GHz - 5.2GHz Dual Band Antenna Suite

### 5.1 Supported 802.11a/b/g/n Dual Band Antennas

Several 2.4GHz - 5.2GHz Dual Band antennas are supported to suit your unique deployment. Check the Support site periodically, as newly supported 2.4GHz - 5.2GHz Dual Band antennas are added to this document as they are released.

For detailed information on supported 2.4GHz - 5.2GHz Dual Band antenna models, refer to:

- *ML-2452-APA2-01 Indoor Dual Band Elbow Jointed Dipole: RP-SMA Male (Black) ML-2452-APA2-02 Indoor Dual Band Elbow Jointed Dipole: RP-SMA Male (White)*
- *ML-2452-PNA5-01R Dual Band Directional Panel: Connector Type N-Male*
- *ML-2452-PNA7-01R Dual Band Panel: Connector Type N-Male*
- *ML-2452-PTA2M3X3-1 AP-7131 MIMO Facade: 1 IN, RPSMA*
- *ML-2452-PTA3M3-036 Ceiling Mount, Dual Band, MIMO Patch: RPSMA*
- *ML-2452-HPA5-036 Dipole, RP-SMA-Male*
- *ML-2452-PNL9M3-036 MIMO Dual Band Selector, RP-SMA Male*
- *ML-2452-APAG2A1-01 Dipole, RP-SMA Male (Black) ML-2452-APAG2A1-02 Dipole, RP-SMA Male (White)*
- *ML-2452-HPAG4A6-01 Outdoor Dipole Omni N-Male*
- *ML-2452-HPAG5A8-01 Outdoor Dipole Omni N-Male*
- *ML-2452-PTA6X6-036 Indoor dual-band MIMO Omni Array, RP-SMA Male*
- *ML-2452-HPA6X6-036 802.11ABG 6-Port Omni Dipole Array, Type N Male x6*
- *ML-2452-PTA2M2-036 802.11ABG 2-Port Patch Array, RP-SMA Male*
- *ML-2452-PTA6M6-036 Six-Port Omnidirectional Panel, RP-SMA Male*
- *ML-2452-PTA6M6-1 Six-Port PIFA Array, RP-SMA Male*
- *ML-2452-HPA6M6-072 11ABGN, 6P DB Omni, 2.0/4.8 dBi, LP, CBL 72, RP -SMA-M*
- *ML-2452-VMM3M3-036 11ABGN, 3-Port Omni Array, RP-SMA Male x 3*
- *AP6562 Internal 802.11ABGN, Multi-Element x 2*
- *AP8222 Internal 802.11ABGN, 6 x PIFA, -1.8 dBi, LP, U.FI*
- *AP-7522 and AP-7532 Dual-Band Monopole (2.4/5 Ghz)*
- *ML-2452-PNL3M3-1 11ABGN, 3-Port Directional Panel, 9.7/9.2 dBi, DP, Fixed N-Type Female*
- *ML-2452-HPA6-01, 11ABGN, Dipole, N-Type Male*
- *AP7502 Internal 802.11ABGNac, Dipole Omni x4*
- *ML-2452-PNL6M3-N36, 11ABGN, 120° Sector, 3-Port, 6/6 dBi, LP, CBL 36, N-Type-M*

- *ML-2452-SEC6M3-N36 , 11ABGN, 3-Port, Multi-Pol, Dir Panel, 6.5/5.0 dBi, LP, CBL 36, N-Type-M*
- *ML-2452-VMM5M3-N72, 11ABGN, 3-Port Dual-Band, Vertical Polarization Omni Array*
- *ML-2452-PNL9M3-N36, 11ABGN, 3-Port Dual-Band, Dual Polarization Dir Panel2 V-Pol and 1 H-Pol ports*

**5.1.1 ML-2452-APA2-01 Indoor Dual Band Elbow Jointed Dipole: RP-SMA Male (Black)**  
**ML-2452-APA2-02 Indoor Dual Band Elbow Jointed Dipole: RP-SMA Male (White)**

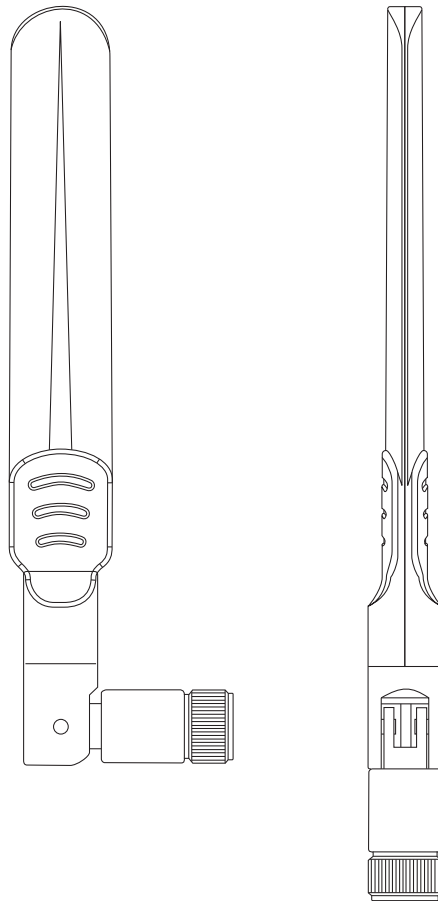

<i>Type</i>	Dipole
<i>Frequency</i>	2400-2500/5150-5850 MHz
<i>Max Gain (dBi)</i>	3.2 / 5.2
<i>Polarization</i>	Linear, Vertical
<i>Azimuth</i>	3dB Beamwidth: 360°/360°
<i>Elevation</i>	3dB Beamwidth: 45°/30°
<i>Cable Length (in.)</i>	N/A
<i>Cable Type</i>	N/A
<i>Connector Type</i>	RP-SMA Male
<i>Weight</i>	0.7 oz
<i>Plenum Antenna</i>	No
<i>Plenum Cable</i>	N/A

<i>Outdoor Rated</i>	No
<i>Storage Temp Range (C)</i>	-10 / +70
<i>Operation Temp Range (C)</i>	-10 / +60



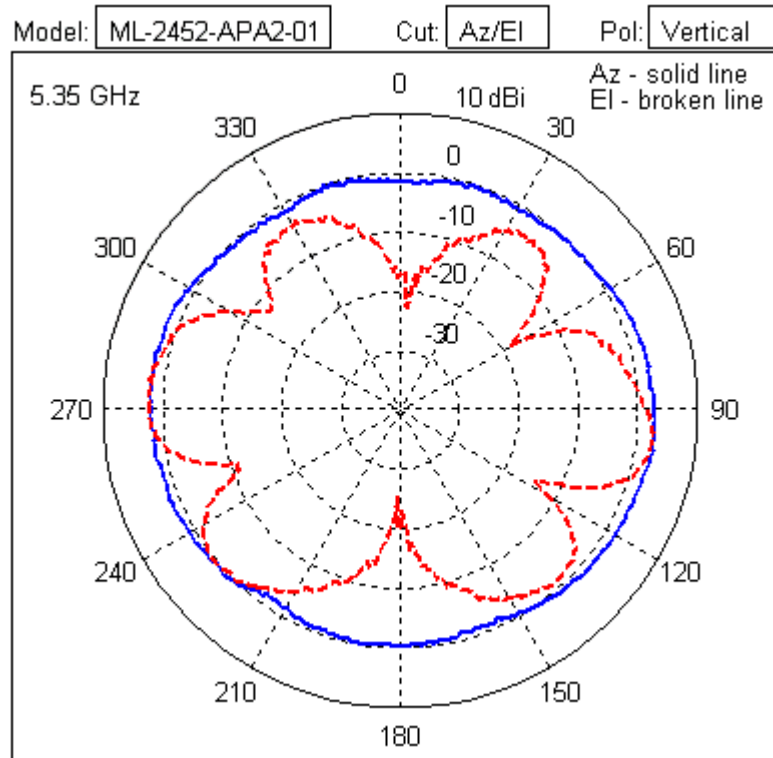
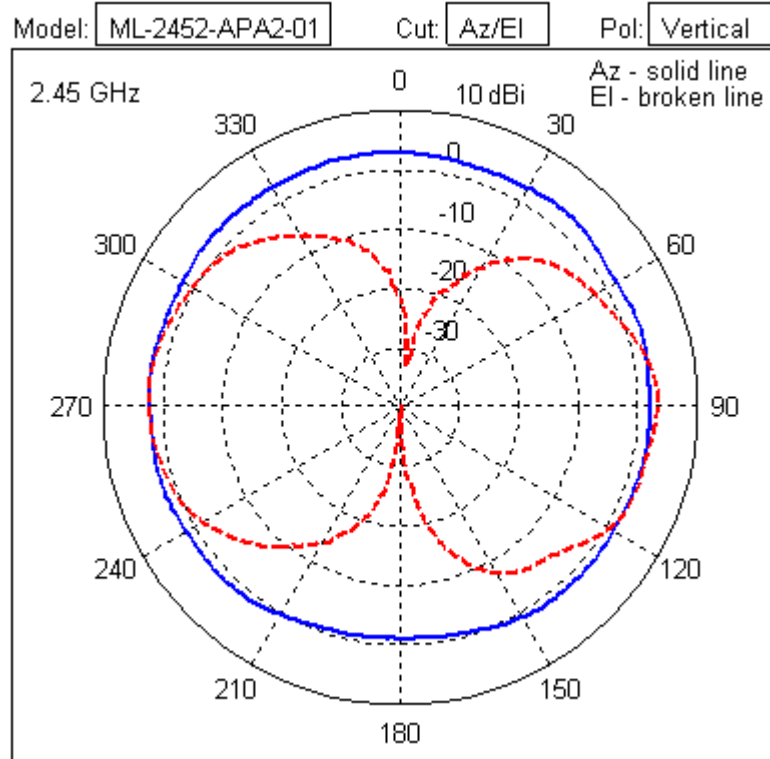

### 5.1.2 ML-2452-PNA5-01R Dual Band Directional Panel: Connector Type N-Male

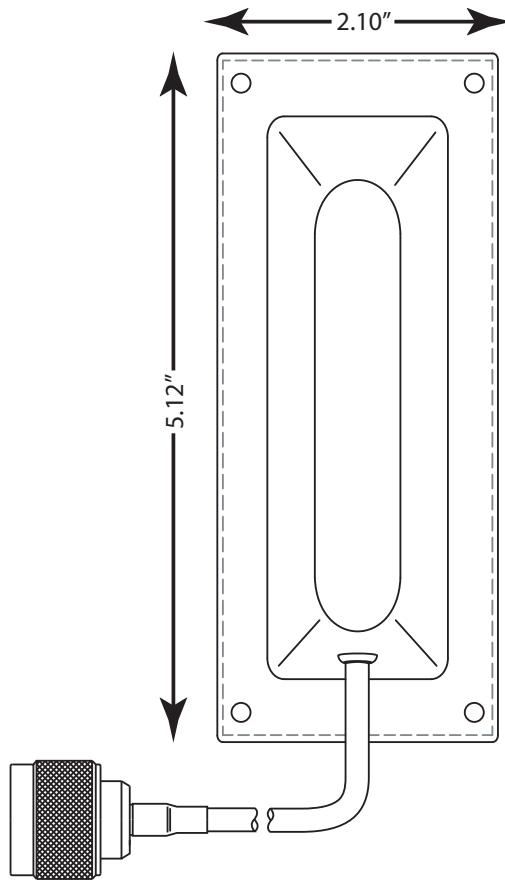

Type	Panel
Frequency	2400-2500/4900-5900 MHz
Max Gain (dBi)	5.5/6.0
Polarization	Linear, Vertical
Azimuth	3dB Beamwidth: 120°/ 120°
Elevation	3dB Beamwidth: 60°/ 60°
Cable Length (in.)	12
Cable Type	RG-58 Ultralink
Connector Type	Type N Male
Weight	0.2 lb
Plenum Antenna	No
Plenum Cable	Yes
Outdoor Rated	Yes

Storage Temp Range (C)	-30 / +70
Operation Temp Range (C)	-30 / +70

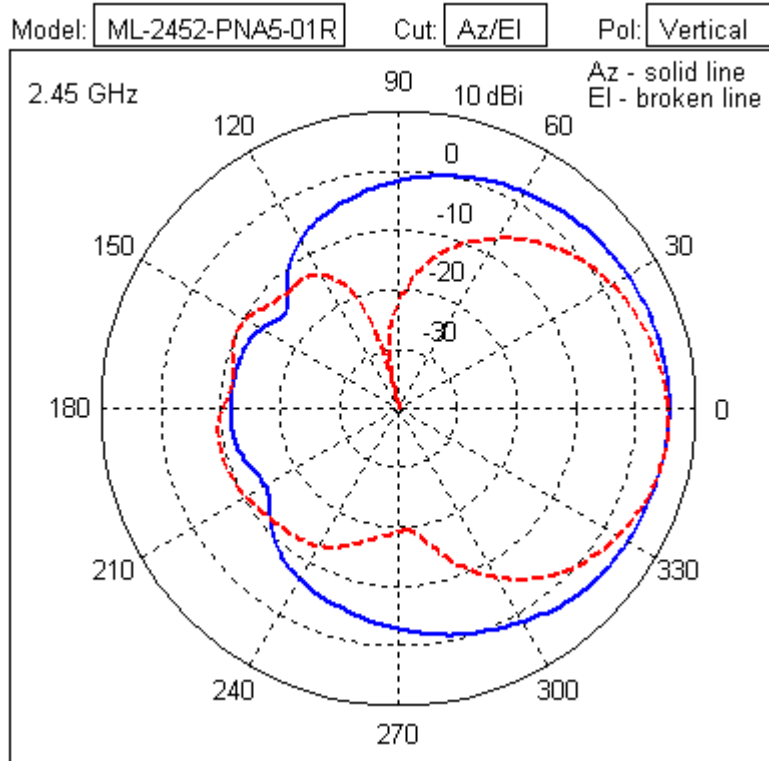

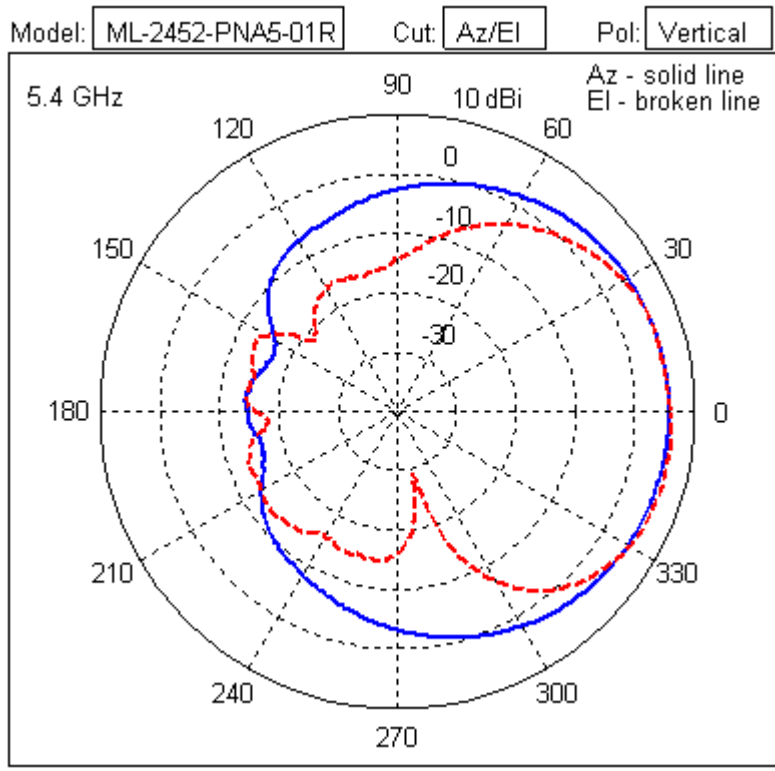

### 5.1.3 ML-2452-PNA7-01R Dual Band Panel: Connector Type N-Male

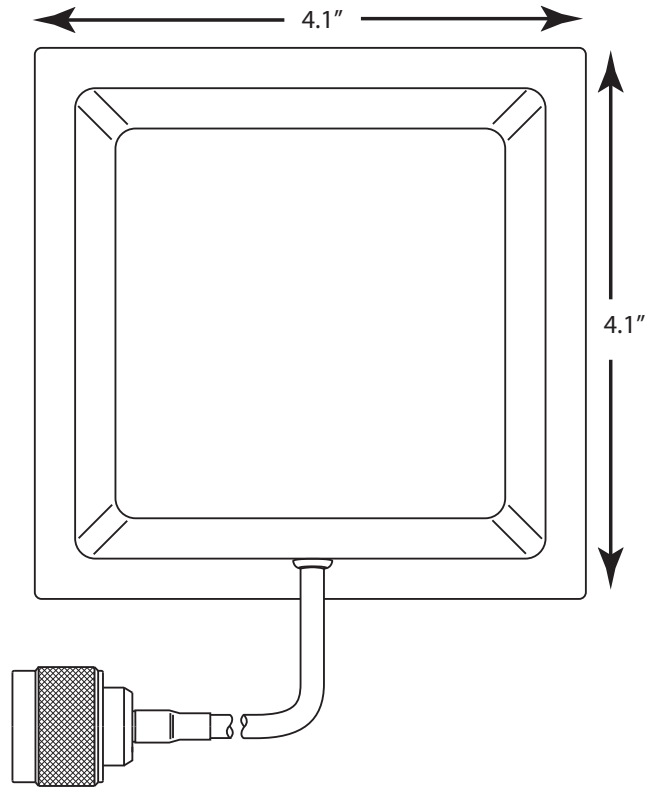

Type	Panel
Frequency	2400-2500/4900-5900 MHz
Max Gain (dBi)	8.0/12.0
Polarization	Linear, Vertical
Azimuth	3dB Beamwidth: 68° / 52°
Elevation	3dB Beamwidth: 66° / 60°
Cable Length (in.)	12
Cable Type	RG-58 Ultralink
Connector Type	Type N Male
Weight	0.5 lb
Plenum Antenna	No
Plenum Cable	Yes
Outdoor Rated	Yes
Storage Temp Range (C)	-40 / +85
Operation Temp Range (C)	-30 / +70

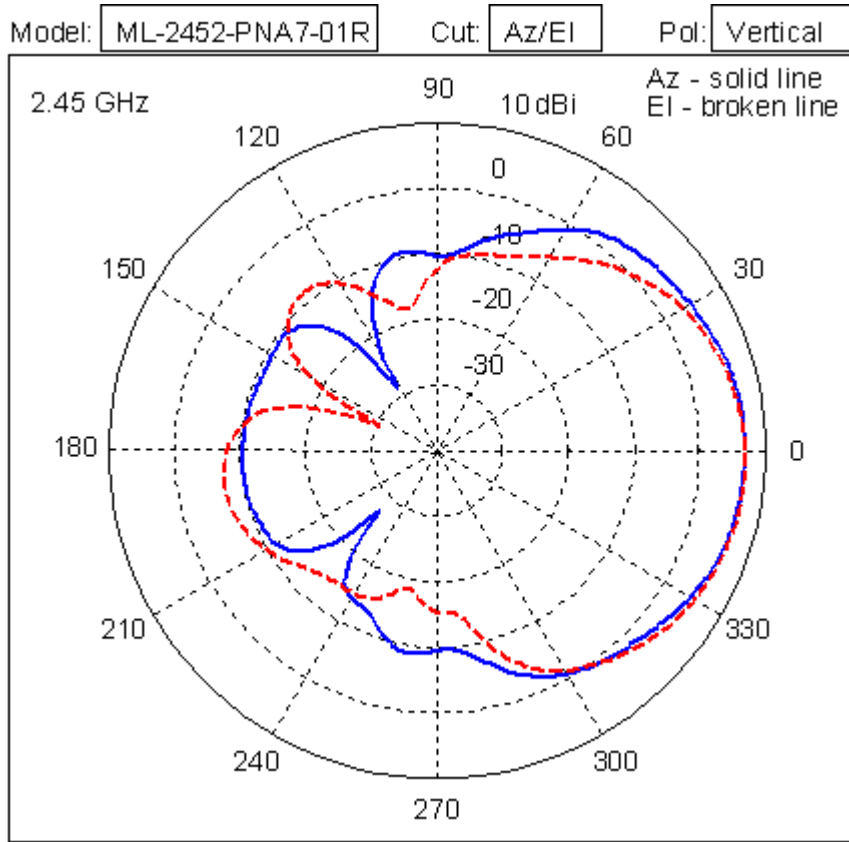

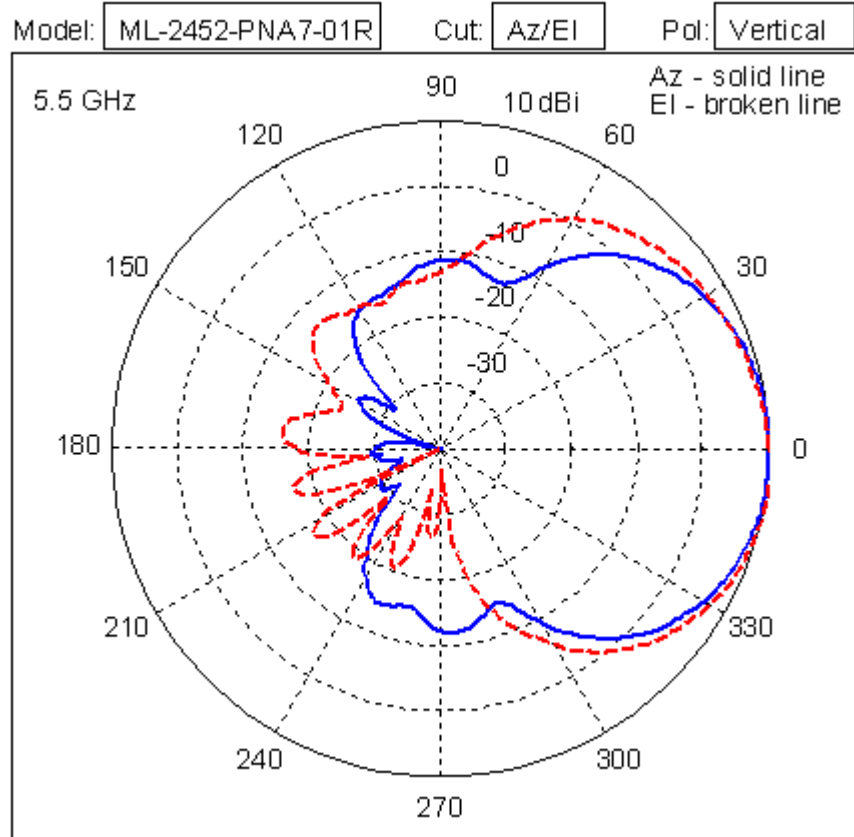

### 5.1.4 ML-2452-PTA2M3X3-1 AP-7131 MIMO Facade: 1 IN, RPSMA

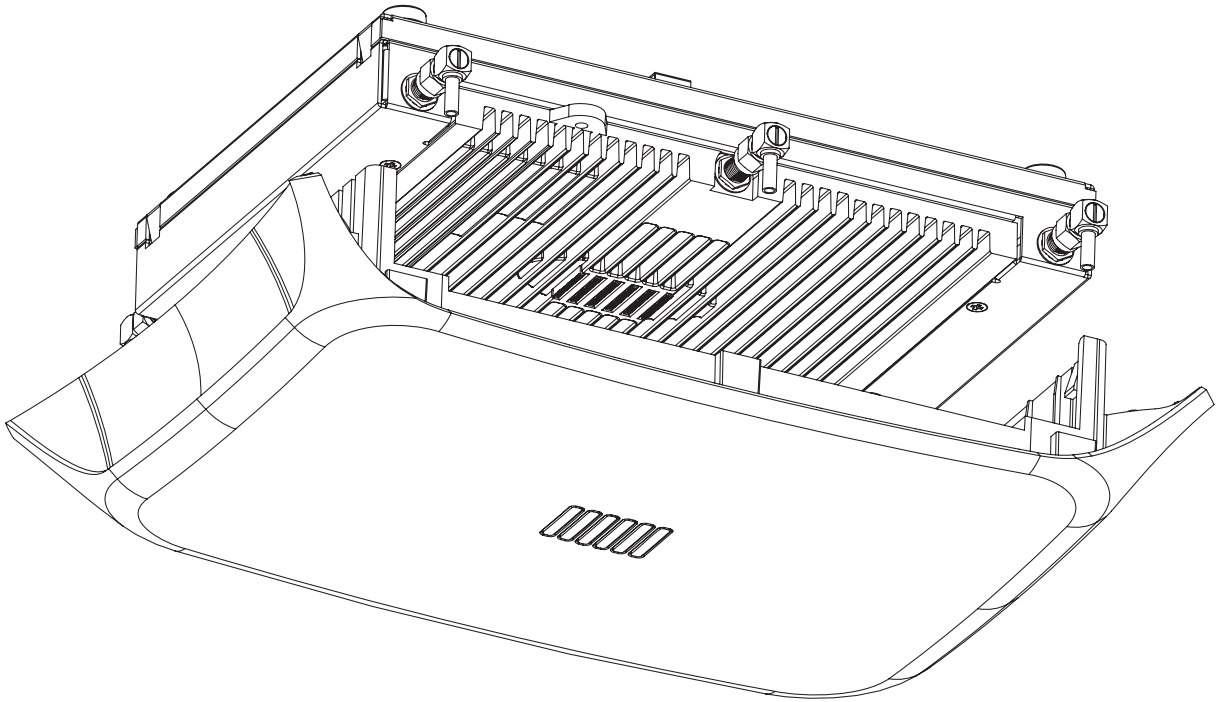

**NOTE:** ML-2452-PTA2M3x3-1 was formally released as part number ML-2452-APA2-FAC.

<i>Type</i>	Patch x 6 in snap-on facade
<i>Frequency</i>	2400-2500/4900-5990 MHz
<i>MAx Gain (dBi)</i>	3.0/5.0
<i>Polarization</i>	Linear, Vertical
<i>Azimuth</i>	3dB Beamwidth: 360°
<i>Elevation</i>	3dB Beamwidth: 90° (southern hemisphere pattern)
<i>Cable Length (in.)</i>	Integrated into snap-on facade
<i>Cable Type</i>	1.20 mm coax
<i>Connector Type</i>	RP-SMA Male
<i>Antenna Plenum Rated</i>	No
<i>Cable Plenum Rated</i>	No
<i>Outdoor Rated</i>	No
<i>Weight</i>	0.79 lb



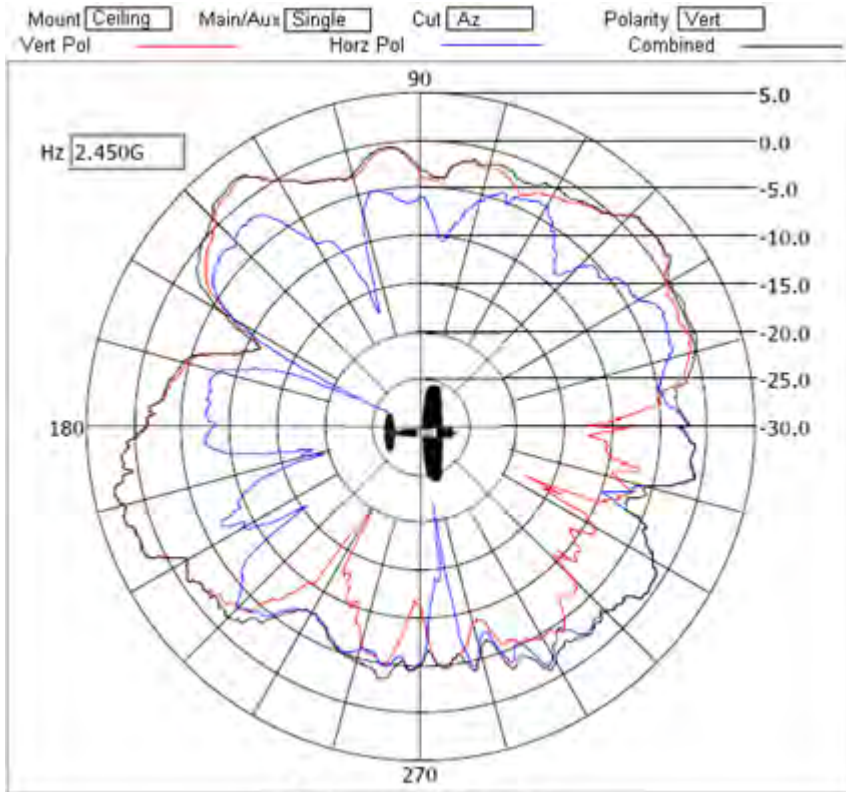

**Azimuth Pattern**

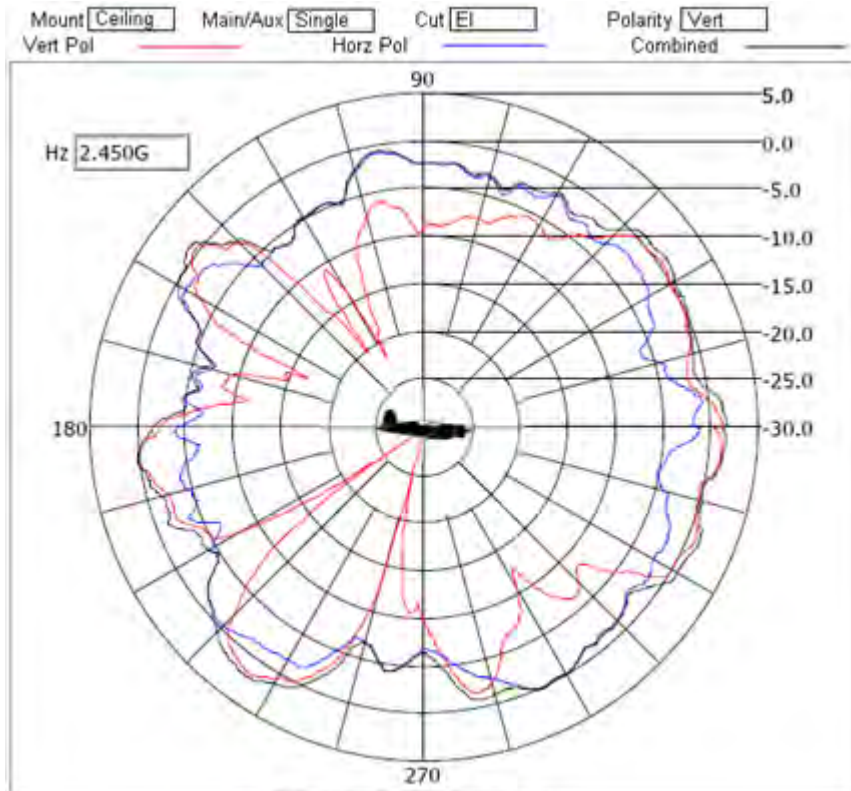

**Elevation Pattern**

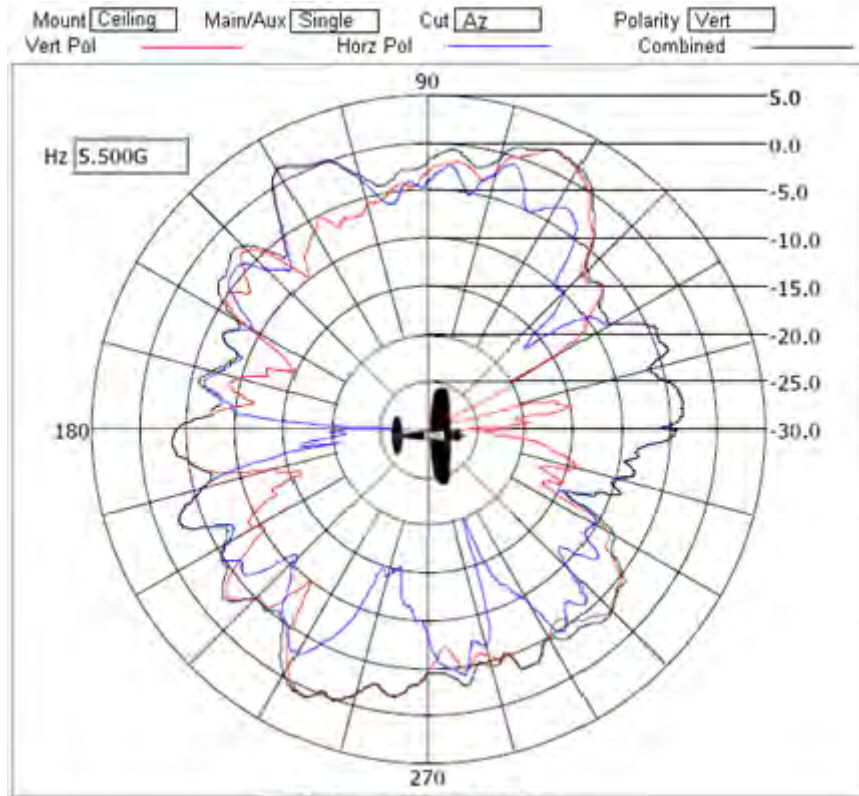

**Azimuth Pattern**

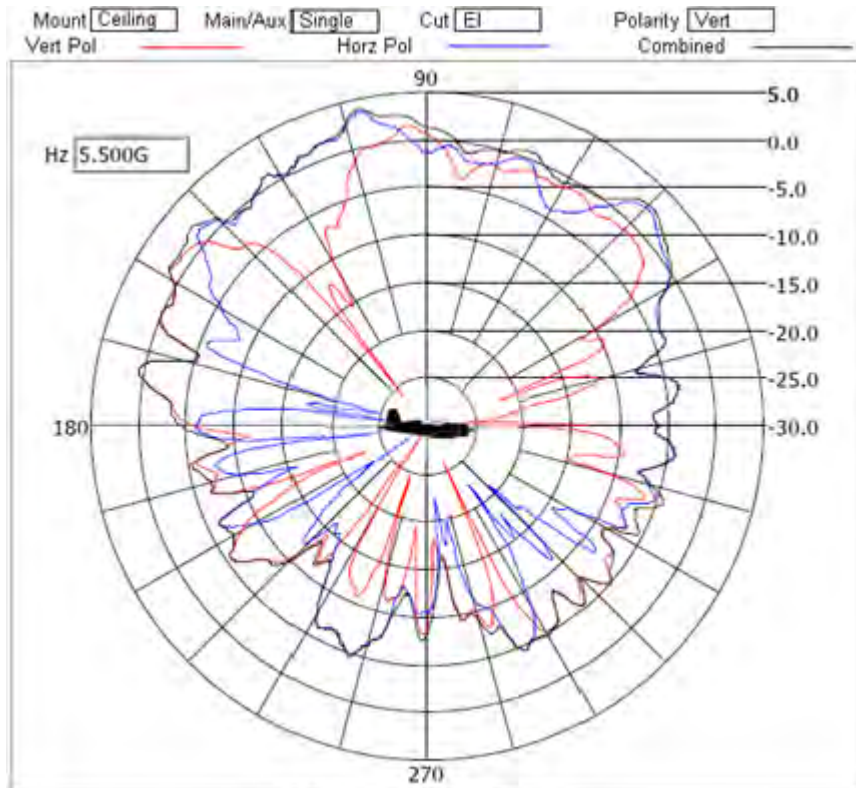

**Elevation Pattern**

### 5.1.5 ML-2452-PTA3M3-036 Ceiling Mount, Dual Band, MIMO Patch: RPSMA

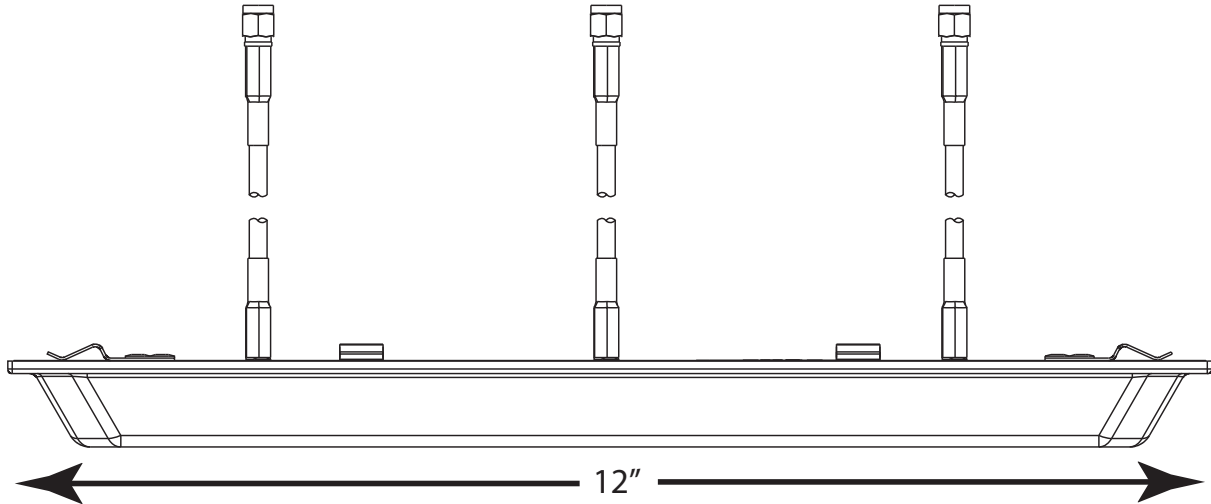

Type	Patch x 3
Frequency	2400-2500/4900-5990 MHz
Max Gain (dBi)	4.0 /5.0
Polarization	Linear, Vertical
Azimuth	3dB Beamwidth: 360° / 360°
Elevation	3dB Beamwidth: 60° / 60° (southern hemisphere pattern)
Cable Length (in.)	36
Cable Type	RG-58
Connector Type	RP-SMA Male
Antenna Plenum Rated	No
Cable Plenum Rated	Yes
Outdoor Rated	No
Weight	0.75 lb
Storage Temp Range (C)	-40 / +85
Operation Temp Range (C)	-35/ +70

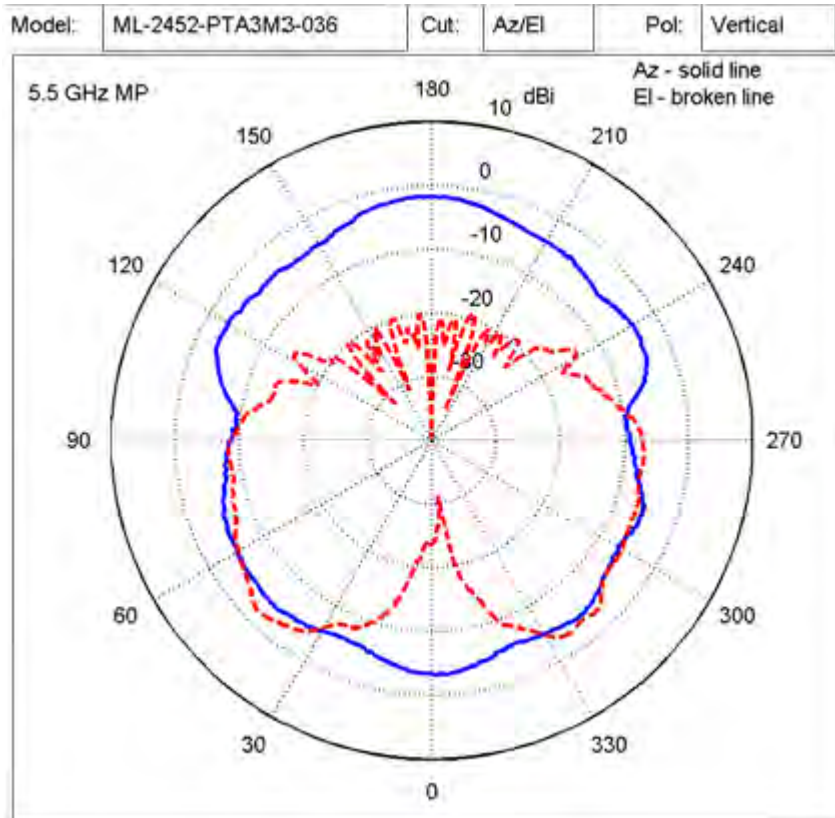
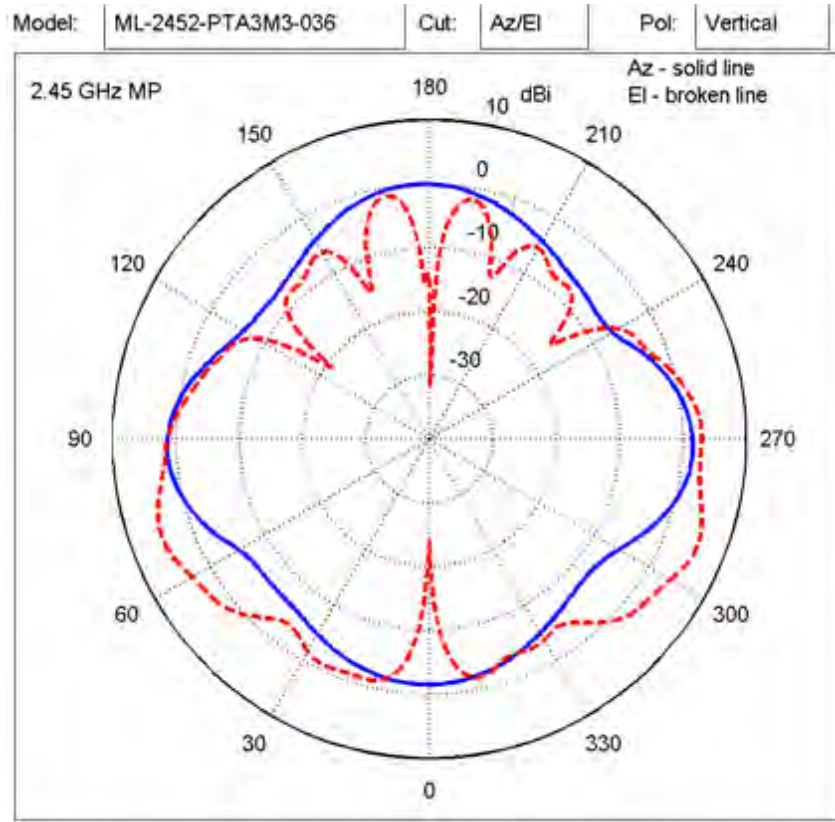

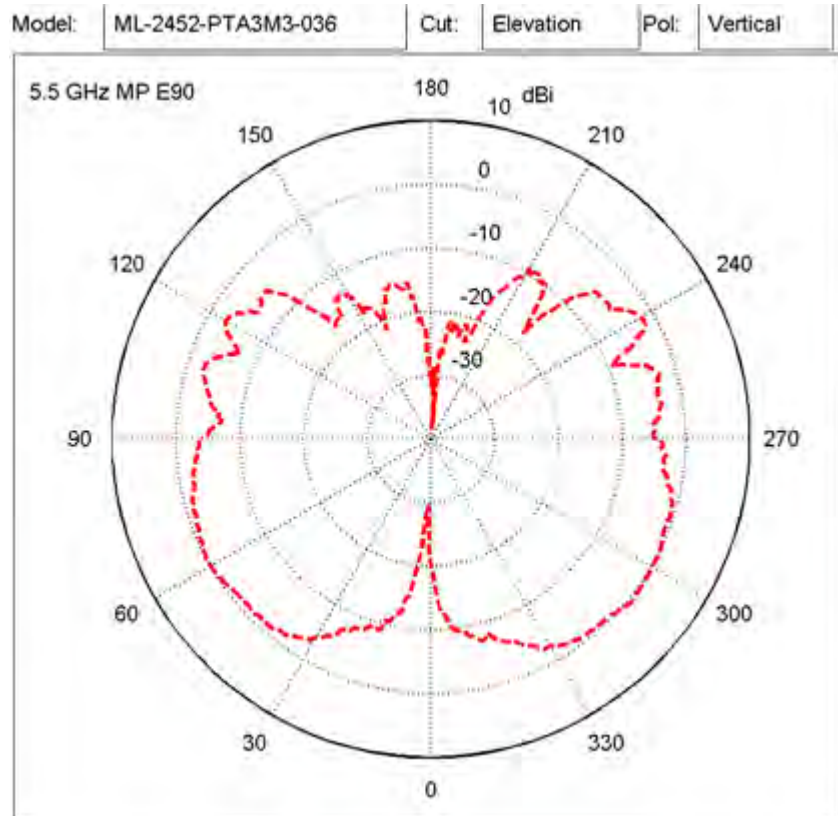
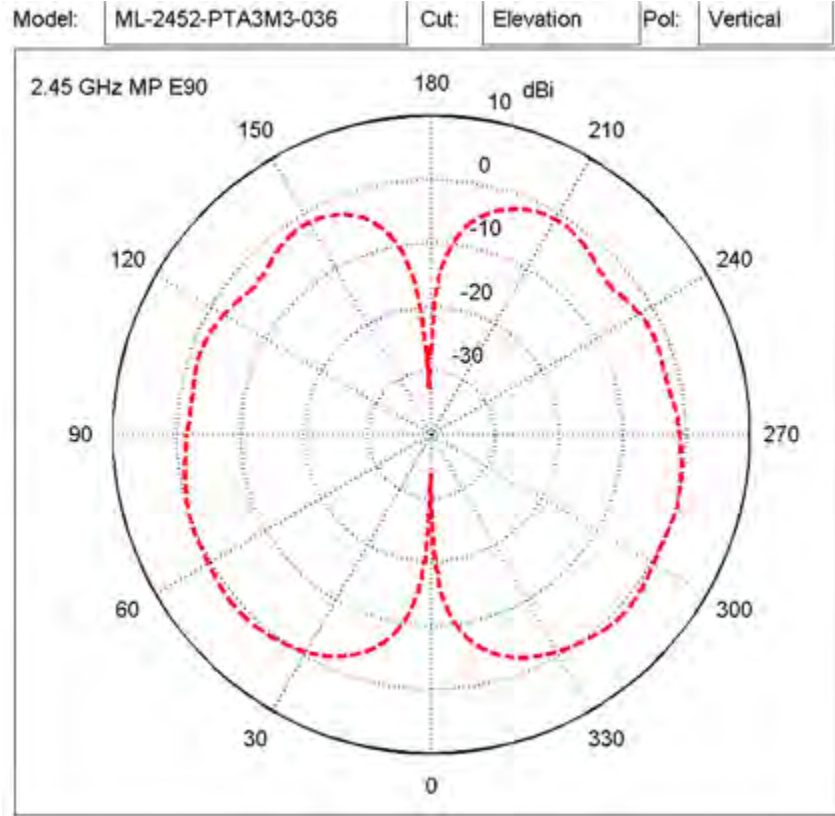

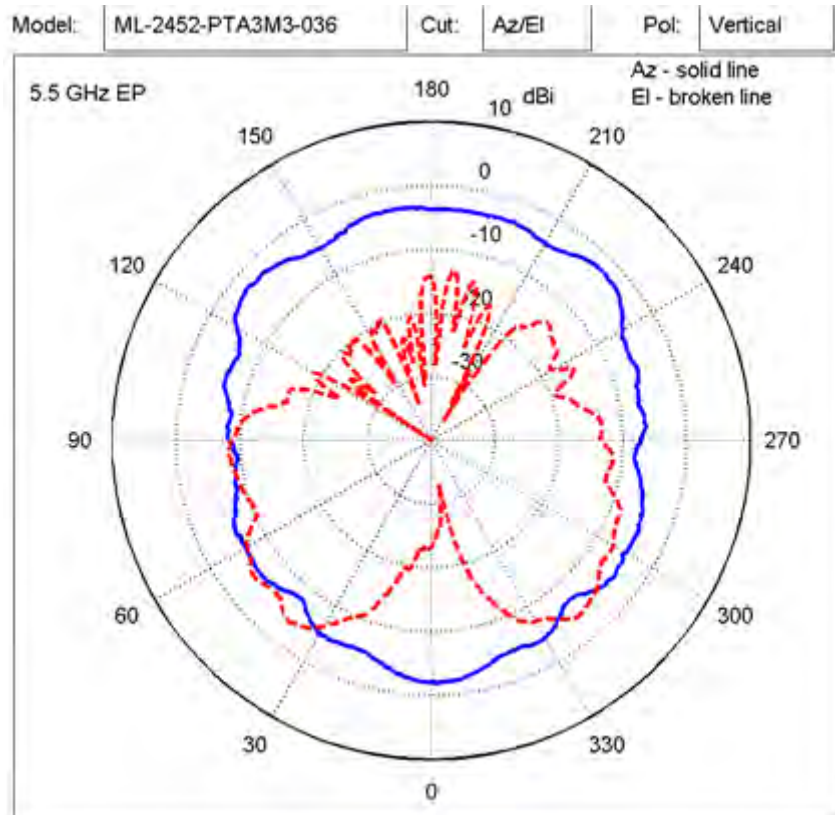
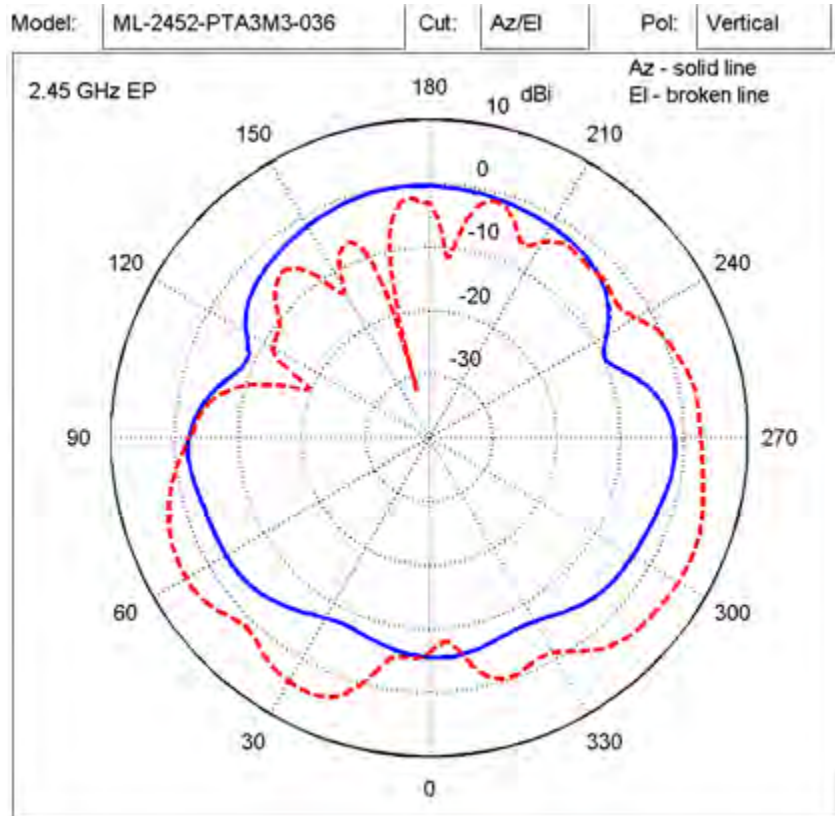

Model: ML-2452-PTA3M3-036    Cut: Elevation    Pol: Vertical

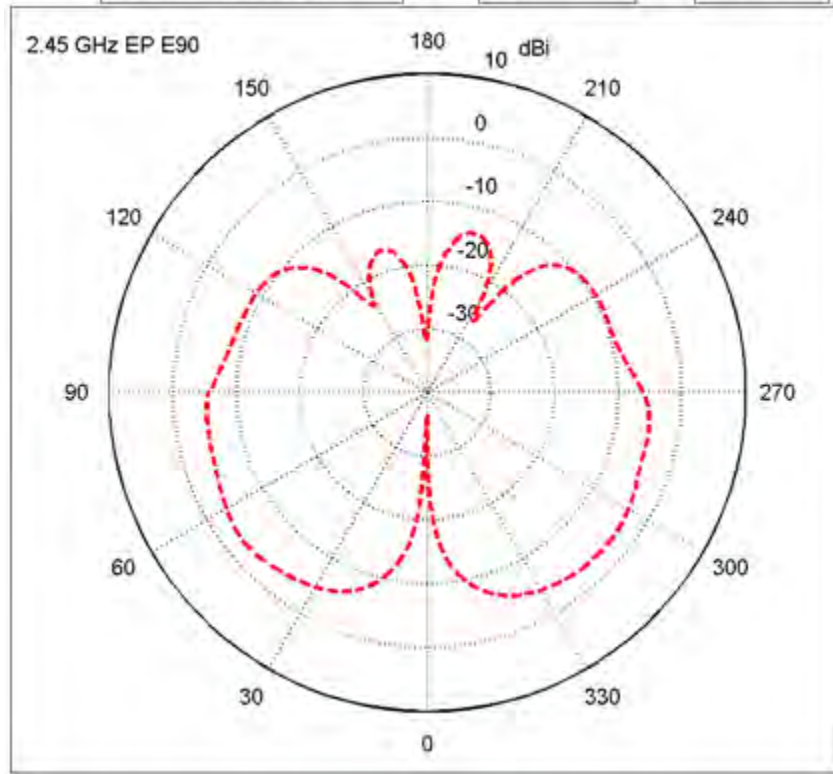

Model: ML-2452-PTA3M3-036    Cut: Az/EI    Pol: Vertical

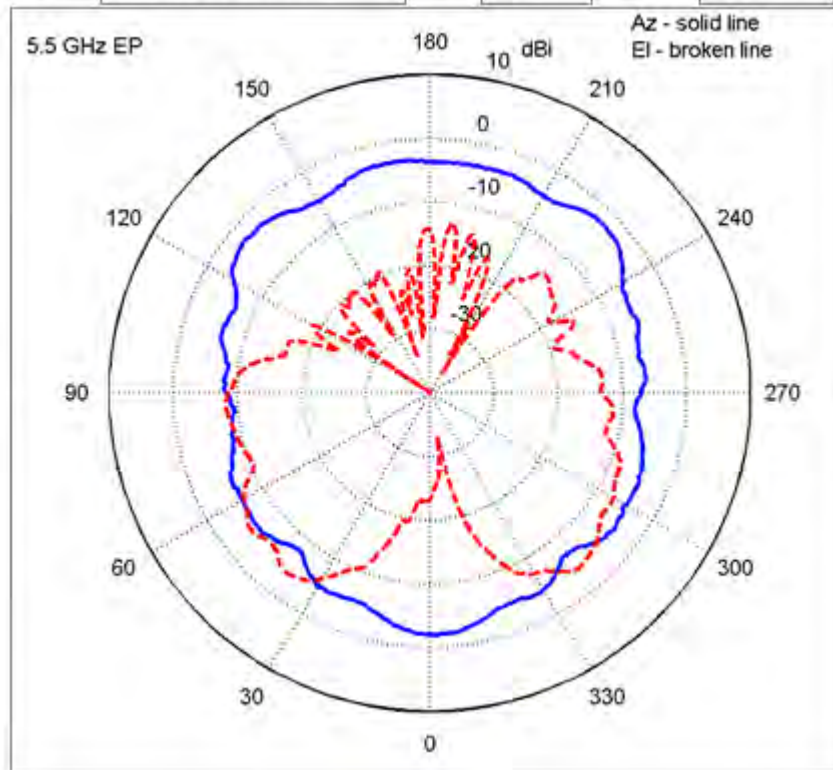

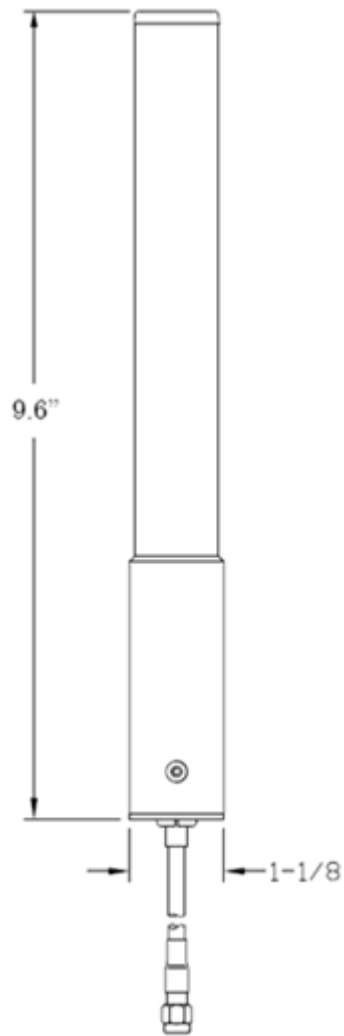
**5.1.6 ML-2452-HPA5-036 Dipole, RP-SMA-Male**

<i>Type</i>	Dipole
<i>Frequency</i>	2450-2500/5150-5875 MHz
<i>Max Gain (dBi)</i>	3.0 / 5.0
<i>Polarization</i>	Linear, Vertical
<i>Azimuth</i>	3dB Beamwidth: 360°/360°
<i>Elevation</i>	3dB Beamwidth: 50°/45°
<i>Cable Length (in.)</i>	36
<i>Cable Type</i>	RG-58 Plenum
<i>Connector Type</i>	RP-SMA Male
<i>Antenna Plenum Rated</i>	N/A
<i>Cable Plenum Rated</i>	Yes
<i>Outdoor Rated</i>	Yes



<i>Weight</i>	0.3 lbs
<i>Storage Temp Range (C)</i>	-40 / +85
<i>Operation Temp Range (C)</i>	-30 / +70

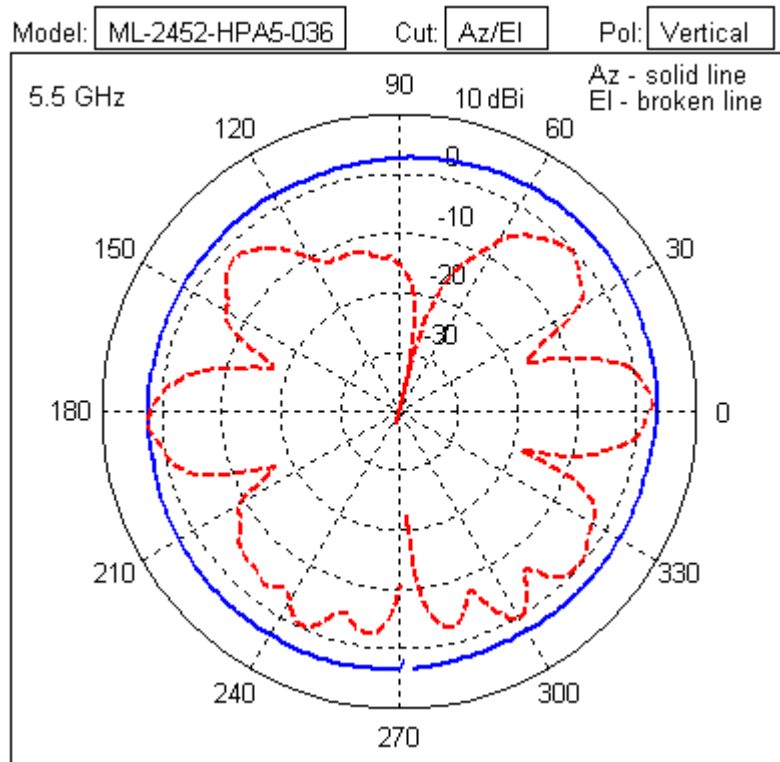
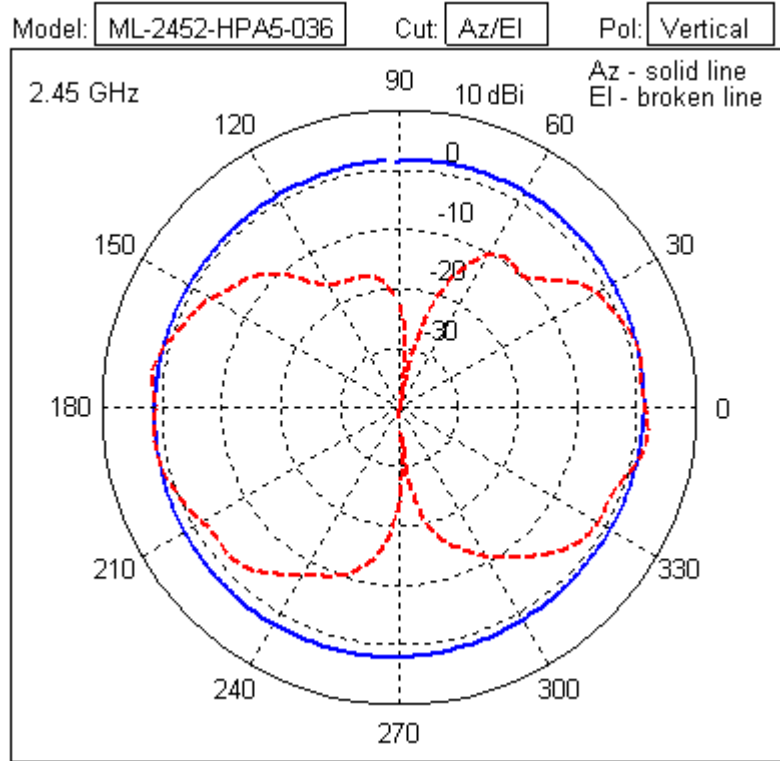

### 5.1.7 ML-2452-PNL9M3-036 MIMO Dual Band Selector, RP-SMA Male

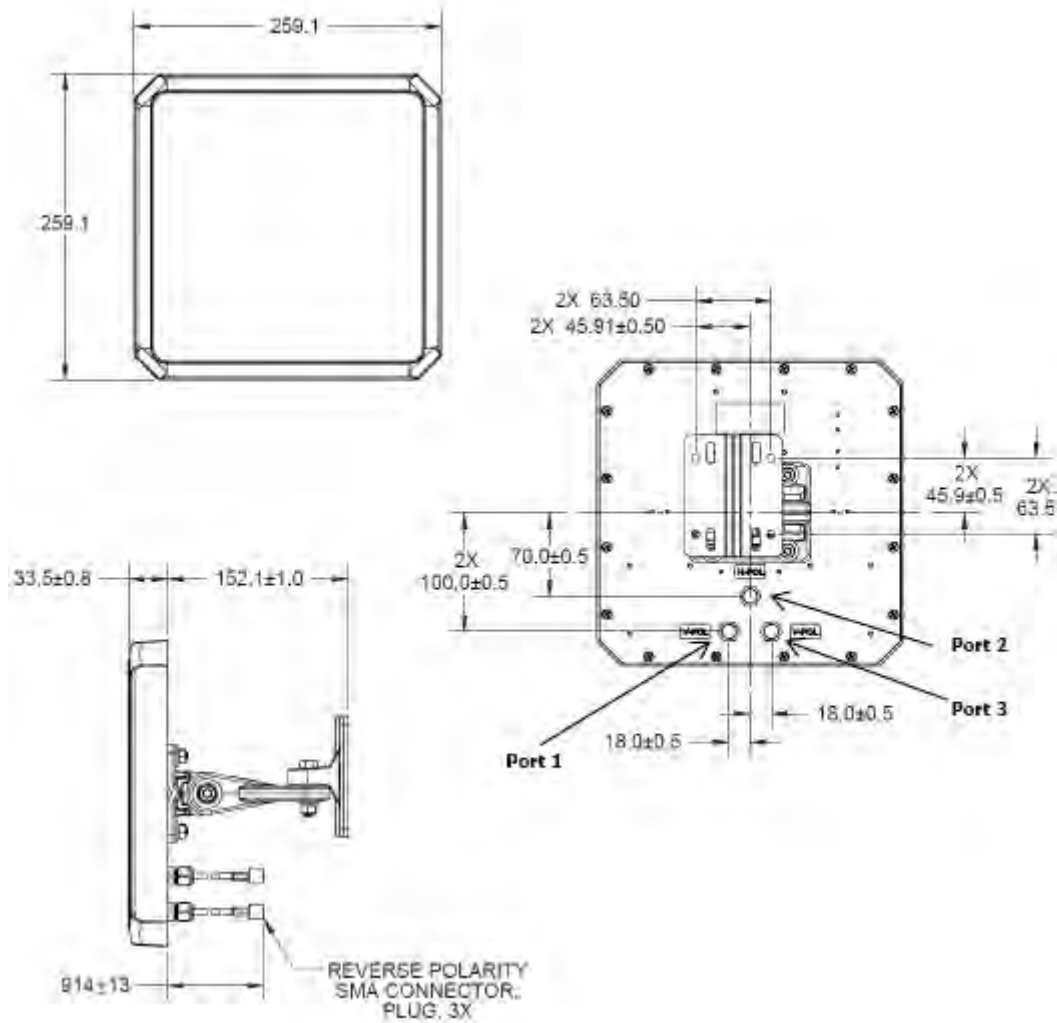

**NOTE:** The dimensions for the ML-2452-PNL9M3-036 model antenna are displayed in millimeters (mm) within the illustration above.

<i>Type</i>	MIMO Dual Band Panel (3 Dual-Band Ports)
<i>Frequency</i>	2400-2500/4900-5875 MHz
<i>Max Gain (dBi)</i>	8.0 / 10.7
<i>Polarization</i>	Linear, 2x Vertical, 1x Horizontal
<i>Azimuth</i>	3dB Beamwidth: 75° / 55°
<i>Elevation</i>	3dB Beamwidth: 70° / 60°
<i>Cable Length (in.)</i>	36
<i>Cable Type</i>	RG-58
<i>Connector Type</i>	RP-SMA Male
<i>Antenna Plenum Rated</i>	N/A
<i>Cable Plenum Rated</i>	Yes
<i>Outdoor Rated</i>	Yes
<i>Weight</i>	1.81 lbs
<i>Storage Temp Range (C)</i>	-40 / +70
<i>Operation Temp Range (C)</i>	-30 / +65

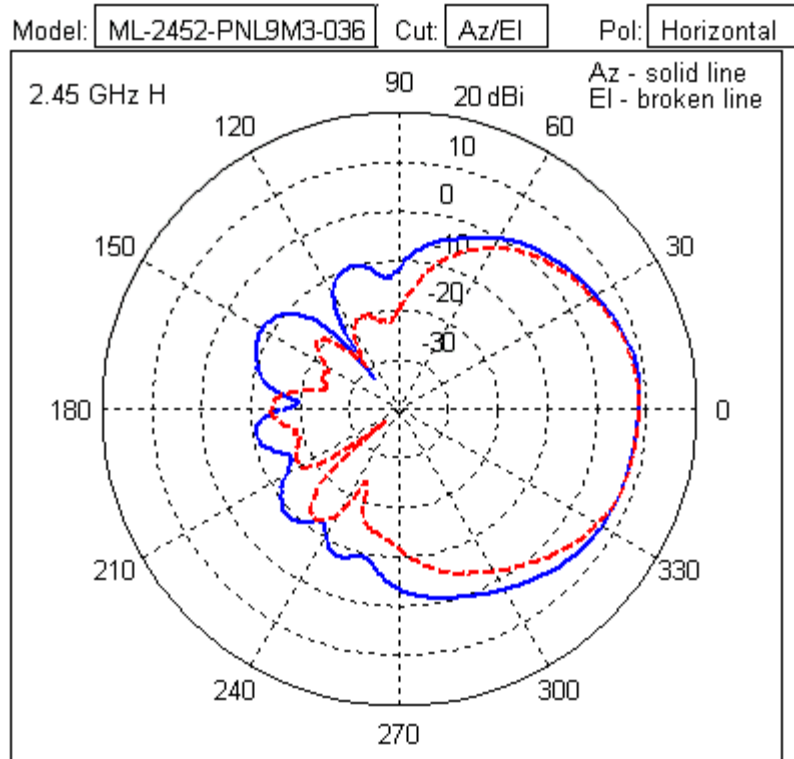
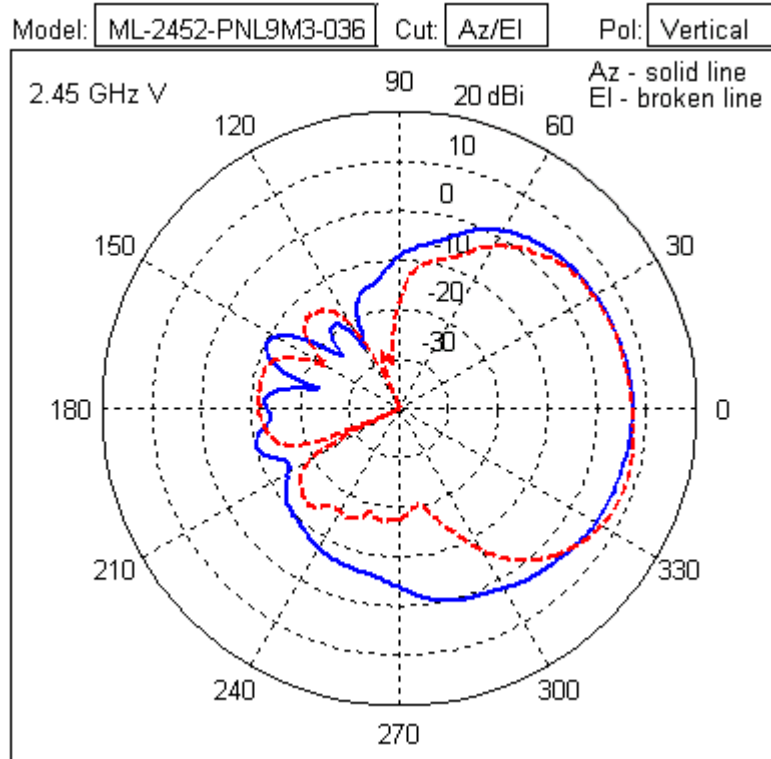

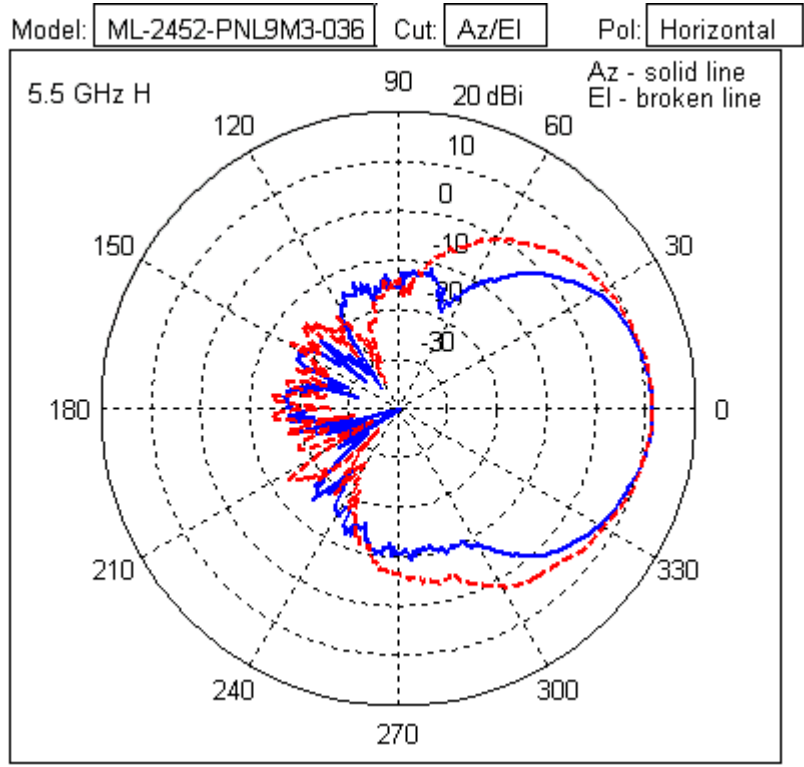
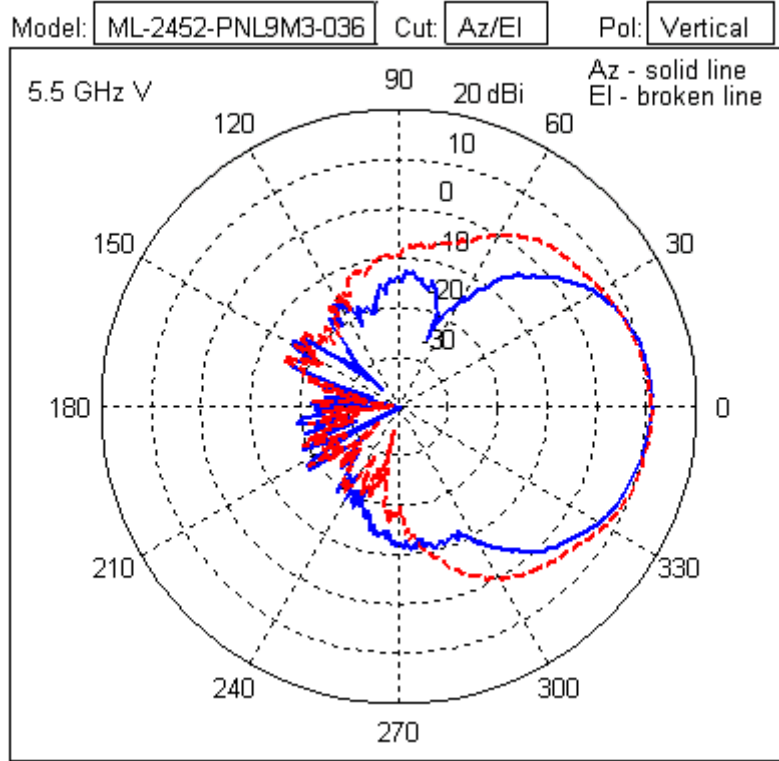



**5.1.8 ML-2452-APAG2A1-01 Dipole, RP-SMA Male (Black)**  
**ML-2452-APAG2A1-02 Dipole, RP-SMA Male (White)**

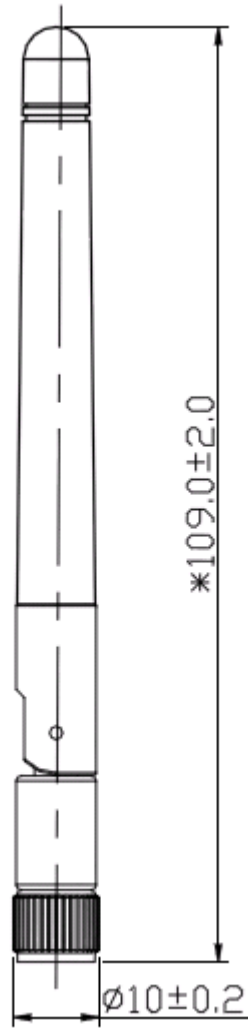



<i>Type</i>	Dipole
<i>Frequency</i>	2400-2500/4900-5900 MHz
<i>Max Gain (dBi)</i>	2.7 / 2.0
<i>Polarization</i>	Linear, Vertical
<i>Azimuth</i>	3 dB Beamwidth: 360° /360°
<i>Elevation</i>	3 dB Beamwidth: 60° /60°
<i>Cable Length (in.)</i>	N/A
<i>Cable Type</i>	N/A
<i>Connector Type</i>	RP-SMA Male
<i>Antenna Plenum Rated</i>	No
<i>Cable Plenum Rated</i>	No
<i>Outdoor Rated</i>	No
<i>Weight</i>	10 g
<i>Storage Temp Range (C)</i>	-40 / +80
<i>Operation Temp Range (C)</i>	-40 / +65

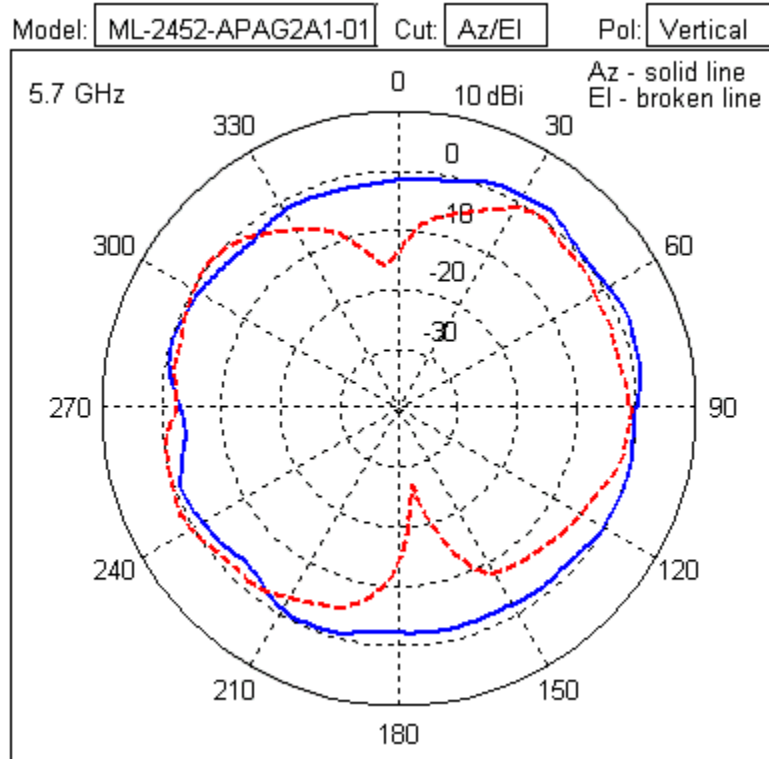
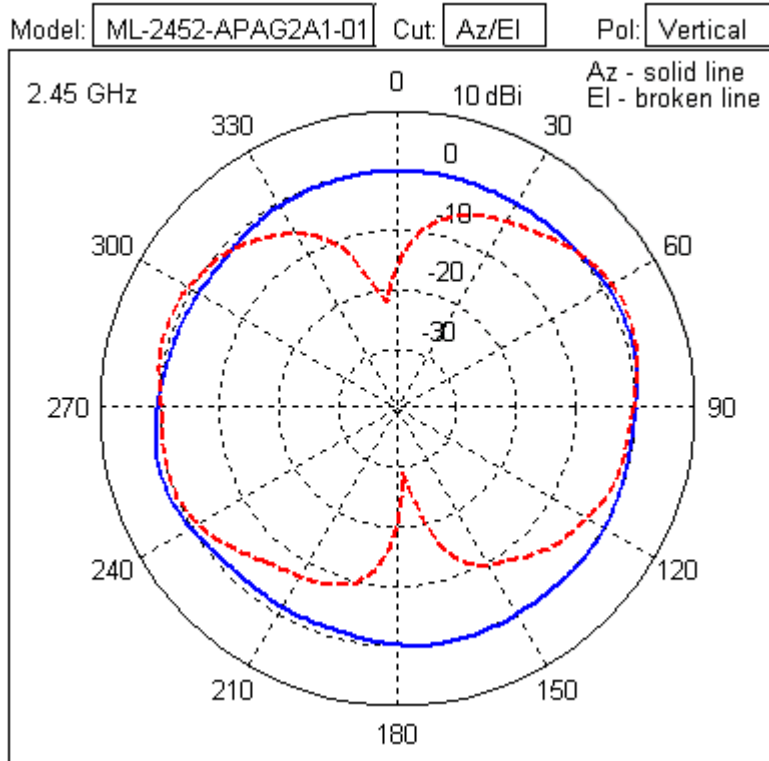

### 5.1.9 ML-2452-HPAG4A6-01 Outdoor Dipole Omni N-Male

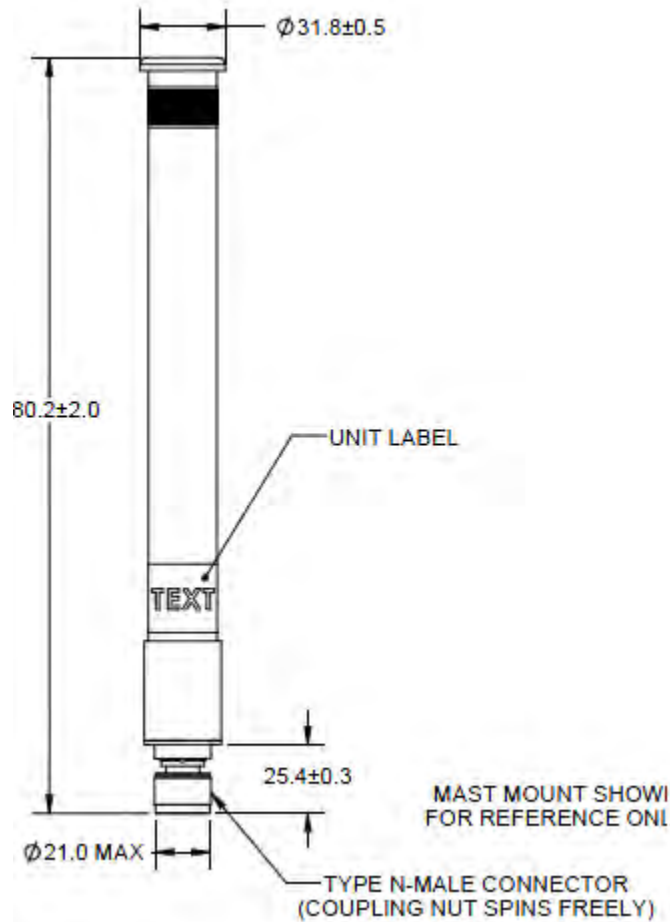

Type	Dual-band Dipole Omni
Frequency	2400-2500/5150-5875 MHz
Max Gain (dBi)	4.0 / 7.3
Elevation Gain (dBi)	5.7
Polarization	Linear, Vertical
Azimuth	3 dB Beamwidth: 360 degrees (2.4 GHz) 3 dB Beamwidth: 360 degrees (5 GHz)
Elevation	3 dB Beamwidth: 50 degrees (2.4 GHz) 3 dB Beamwidth: 18 degrees (5 GHz)
Cable Length (in.)	N/A
Cable Type	N/A
Connector Type	N-type Male
Antenna Plenum Rated	No

<i>Cable Plenum Rated</i>	N/A
<i>Outdoor Rated</i>	Yes
<i>Weight</i>	0.35 lbs
<i>Storage Temp Range (C)</i>	-40 / +85
<i>Operation Temp Range (C)</i>	-30 / +70

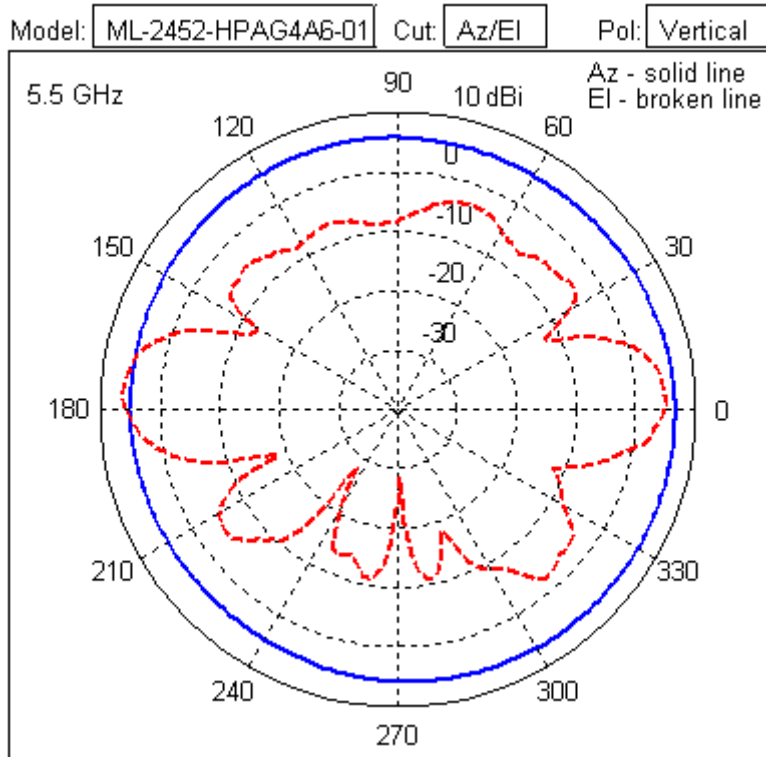
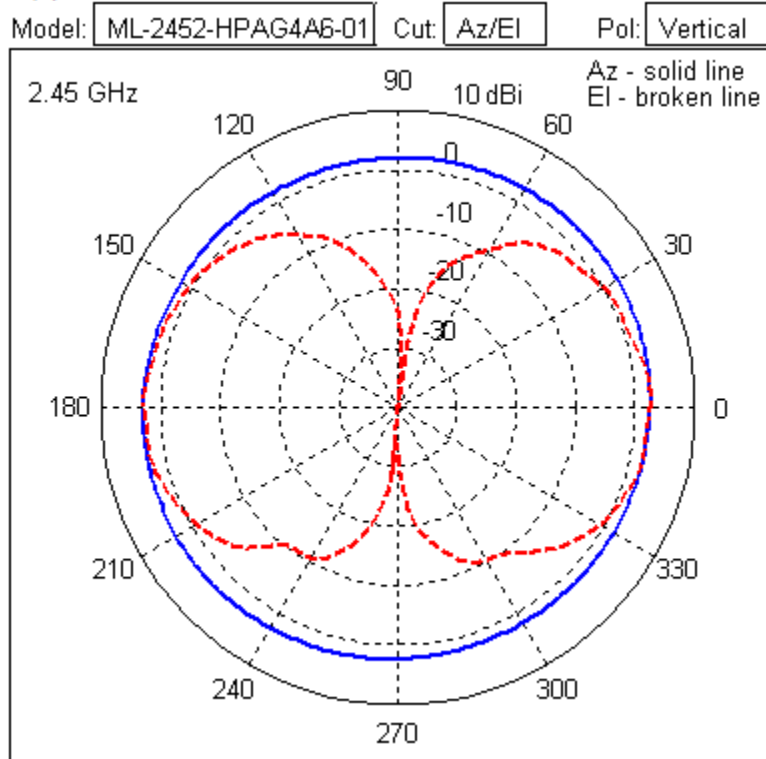

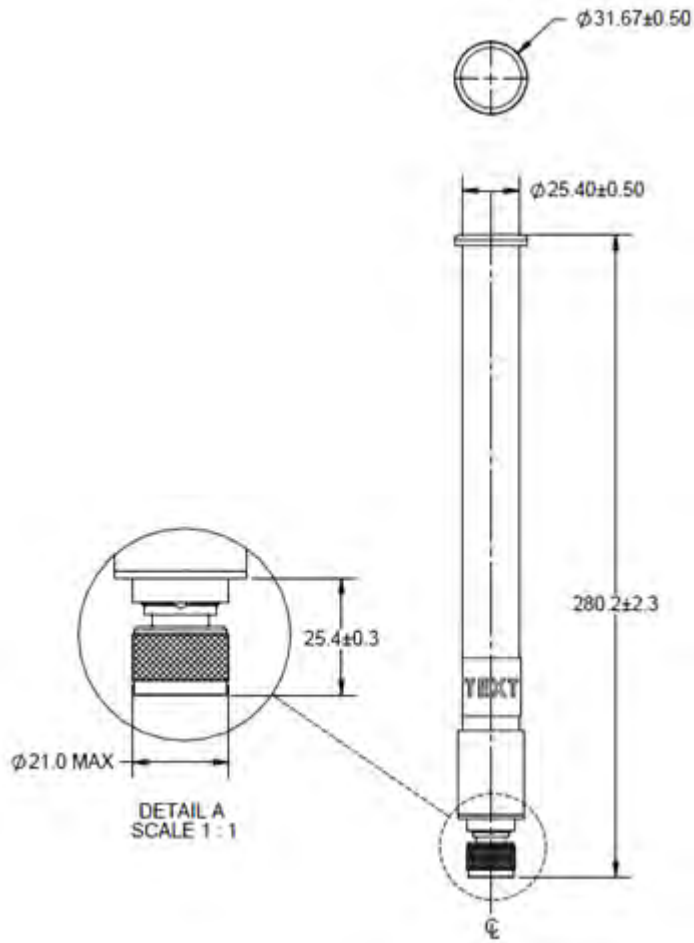
**5.1.10 ML-2452-HPAG5A8-01 Outdoor Dipole Omni N-Male**

<i>Type</i>	Dual-band Dipole Omni
<i>Frequency</i>	2400-2500/5150-5875 MHz
<i>Max Gain (dBi)</i>	7.5/ 8.0
<i>Polarization</i>	Linear, Vertical
<i>Azimuth</i>	3 dB Beamwidth: 360 degrees (2.4 GHz) 3 dB Beamwidth: 360 degrees (5 GHz)
<i>Elevation</i>	3 dB Beamwidth: 28 degrees (2.4 GHz) 3 dB Beamwidth: 15 degrees (5 GHz)
<i>Cable Length (in.)</i>	N/A
<i>Cable Type</i>	N/A
<i>Connector Type</i>	N-type Male
<i>Antenna Plenum Rated</i>	No
<i>Cable Plenum Rated</i>	N/A
<i>Outdoor Rated</i>	Yes
<i>Weight</i>	0.33 lbs

<i>Storage Temp Range (C)</i>	-40 / +85
<i>Operation Temp Range (C)</i>	-30 / +70

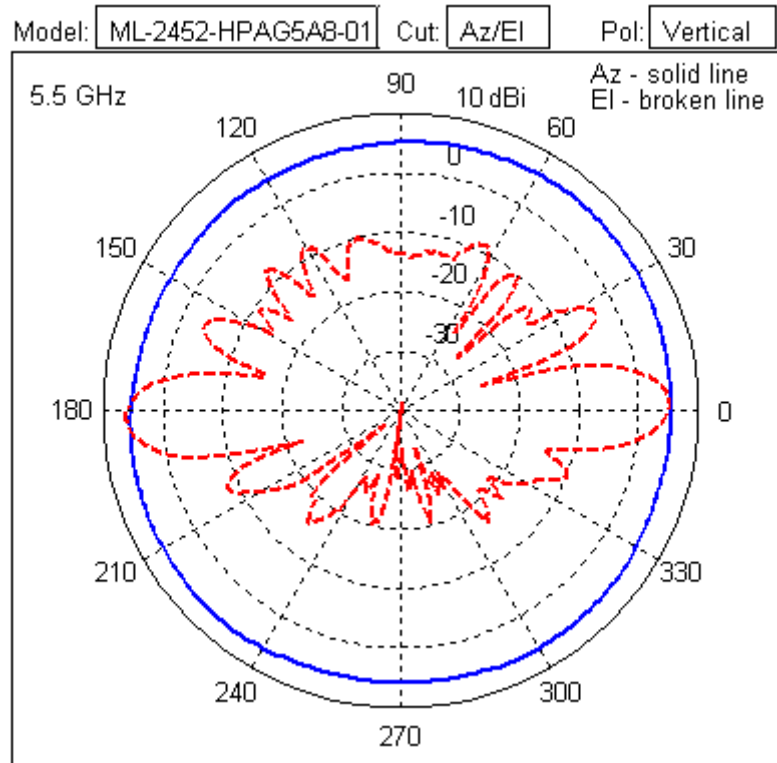
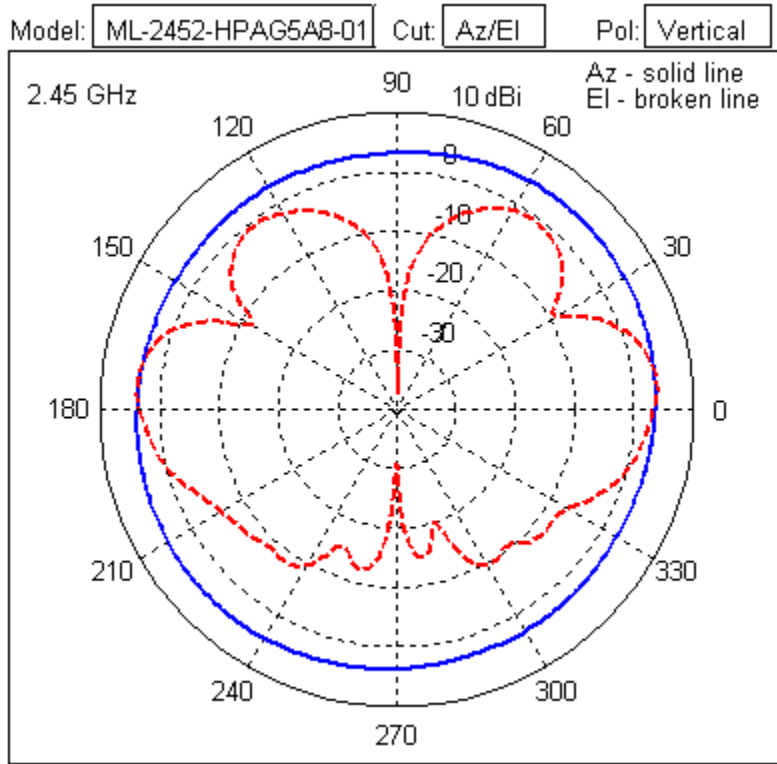



### 5.1.11 ML-2452-PTA6X6-036 Indoor dual-band MIMO Omni Array, RP-SMA Male

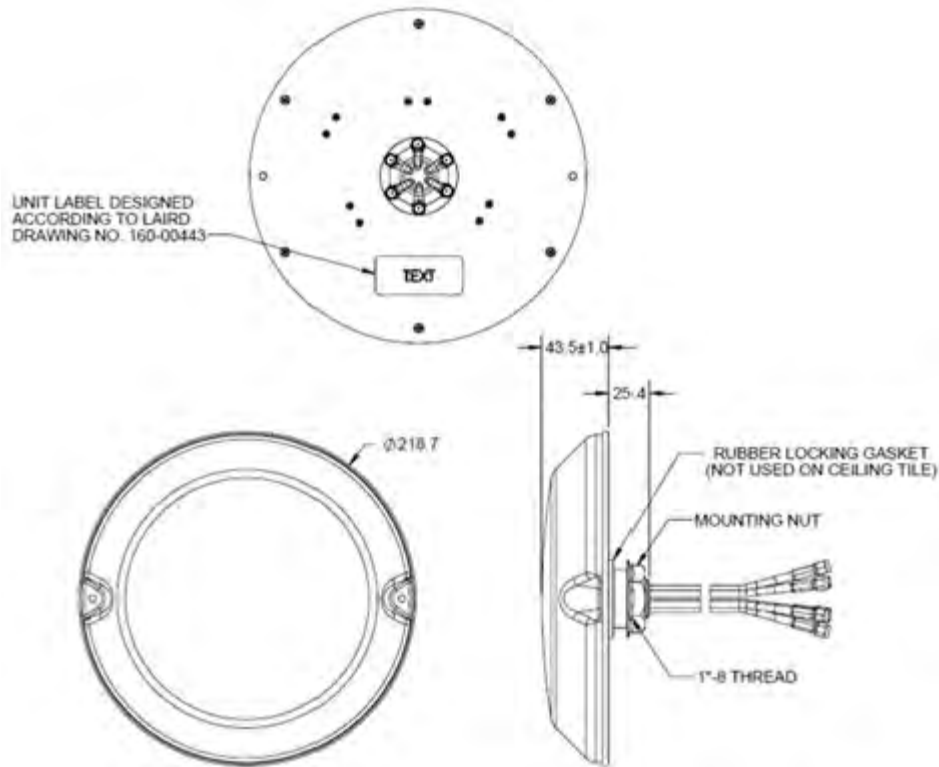

<i>Type</i>	Dual-band MIMO omni patch array, three 2.4G elements, three 5 G elements
<i>Frequency</i>	2400-2500/5150-5850 MHz
<i>Max Gain (dBi)</i>	3.0 / 5.0
<i>Polarization</i>	Linear, Vertical
<i>Azimuth</i>	3 dB Beamwidth: 360 degrees (2.4 GHz) 3 dB Beamwidth: 360 degrees (5 GHz)
<i>Elevation</i>	3 dB Beamwidth: 75 degrees (2.4 GHz) 3 dB Beamwidth: 42 degrees (5 GHz)
<i>Cable Length</i>	91.4 cm
<i>Cable Type</i>	RG-58
<i>Connector Type</i>	RP-SMA Male x 6
<i>Antenna Plenum Rated</i>	No
<i>Cable Plenum Rated</i>	Yes
<i>Outdoor Rated</i>	No
<i>Weight</i>	1.5 lbs
<i>Storage Temp Range (C)</i>	-30 / +70
<i>Operation Temp Range (C)</i>	-30 / +70

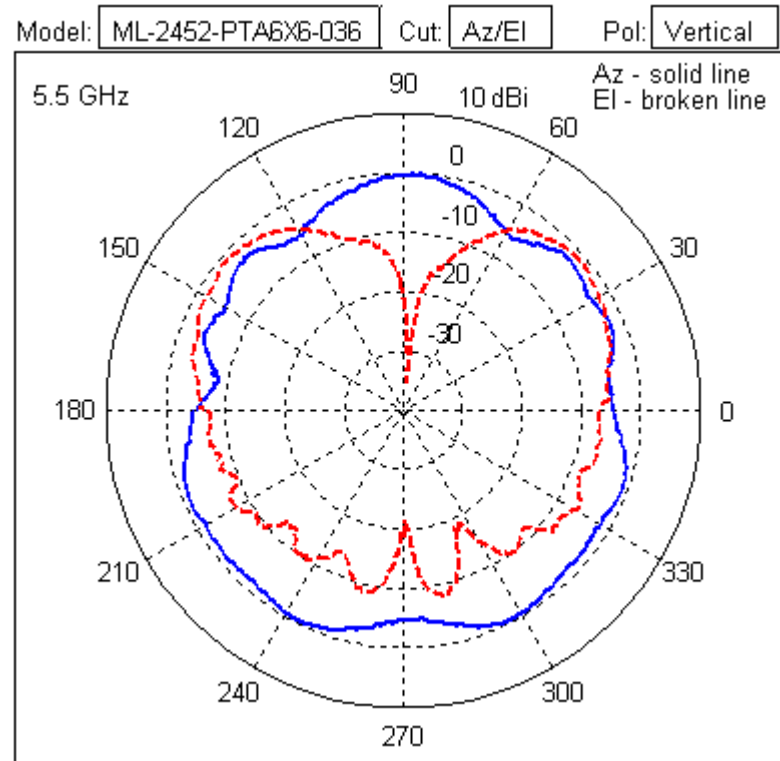
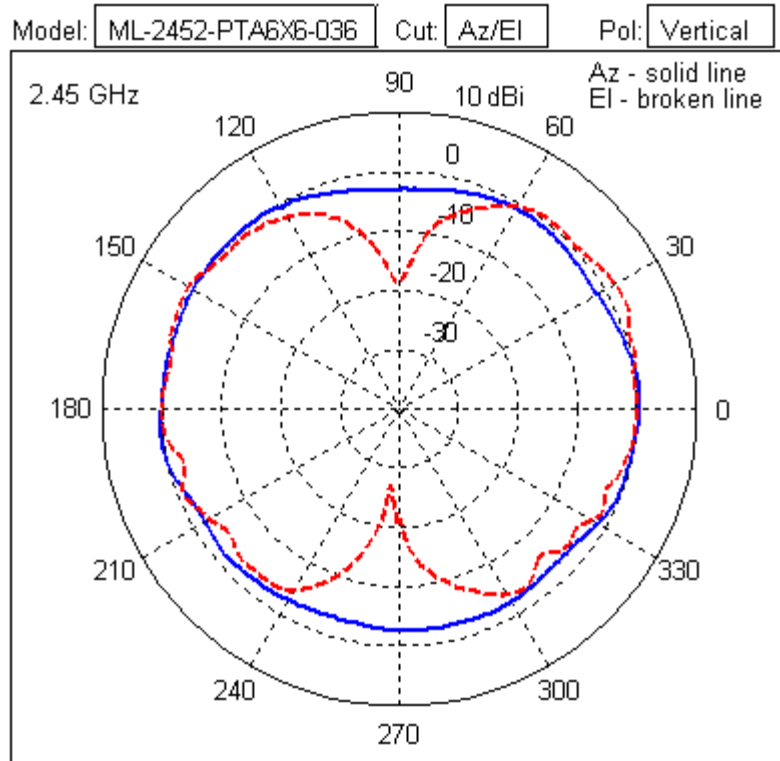

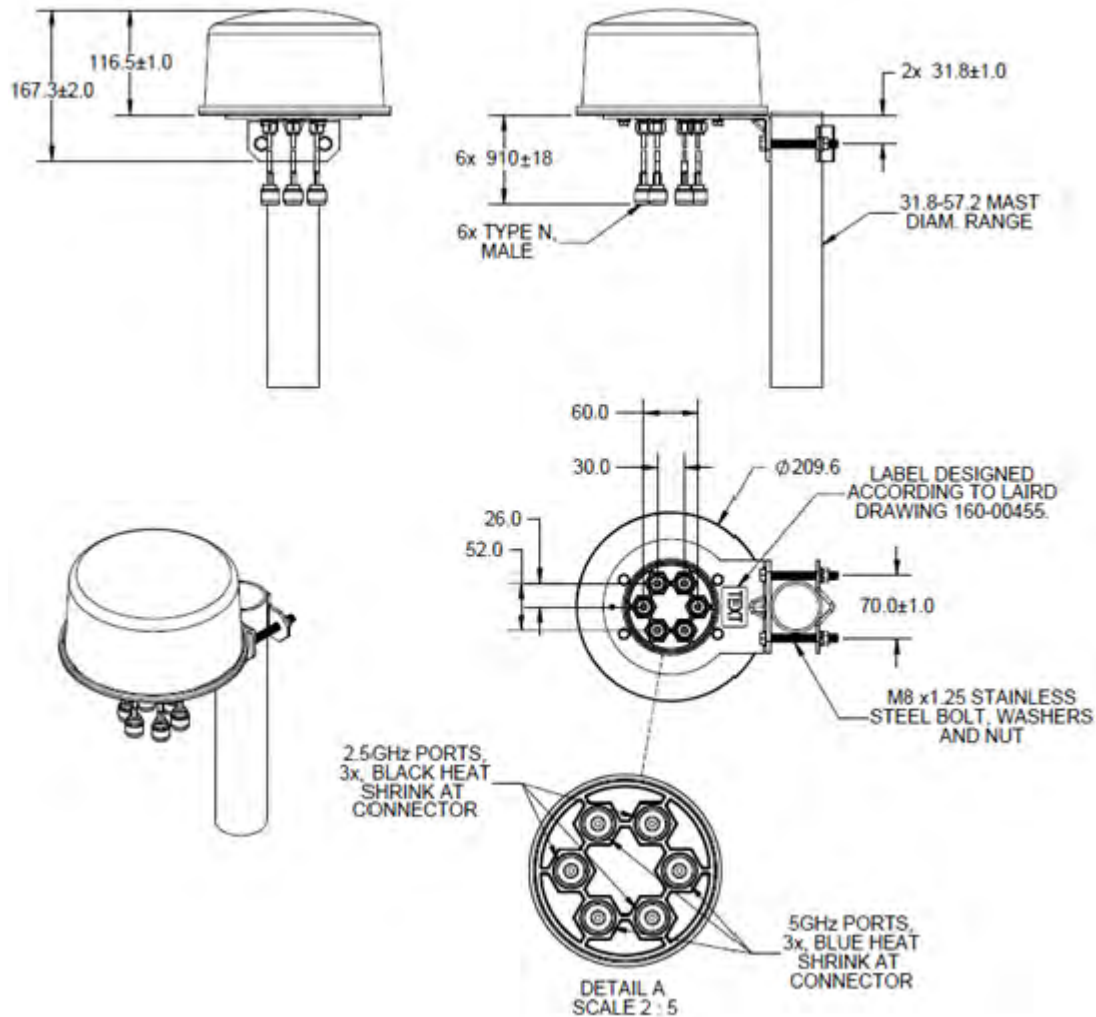
**5.1.12 ML-2452-HPA6X6-036 802.11ABG 6-Port Omni Dipole Array, Type N Male x6**

Type	Six-Port Omni Dipole Array (3x2.4G, 3x5G)
Frequency	2400-2500/4900-5900 MHz
Max Gain (dBi)	4.0 /6.0
Elevation Gain (dBi)	-3.9
Polarization	Linear, Vertical
Azimuth	3 dB Beamwidth: 360 degrees (2.4 GHz) 3 dB Beamwidth: 360 degrees (5 GHz)
Elevation	3 dB Beamwidth: 45 degrees (2.4 GHz) 3 dB Beamwidth: 32 degrees (5 GHz)
Cable Length	91.0 cm
Cable Type	RG-58
Connector Type	Type N Male x 6

<i>Antenna Plenum Rated</i>	N/A
<i>Cable Plenum Rated</i>	Yes
<i>Outdoor Rated</i>	Yes
<i>Weight</i>	2.5 lbs
<i>Storage Temp Range (C)</i>	-40 / +85
<i>Operation Temp Range (C)</i>	-30 / +70

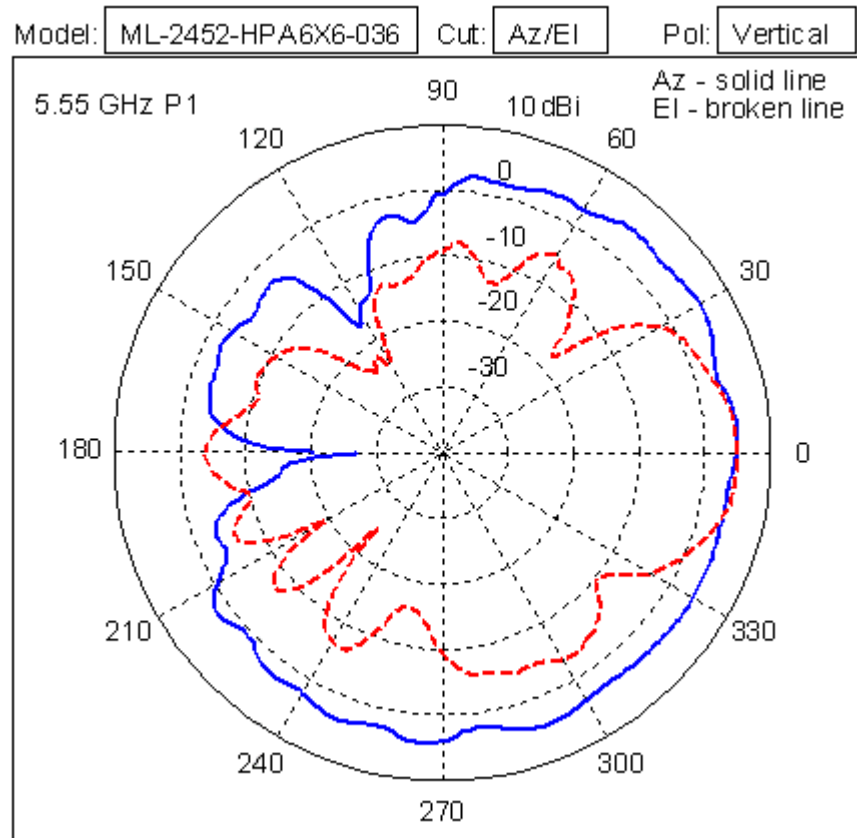
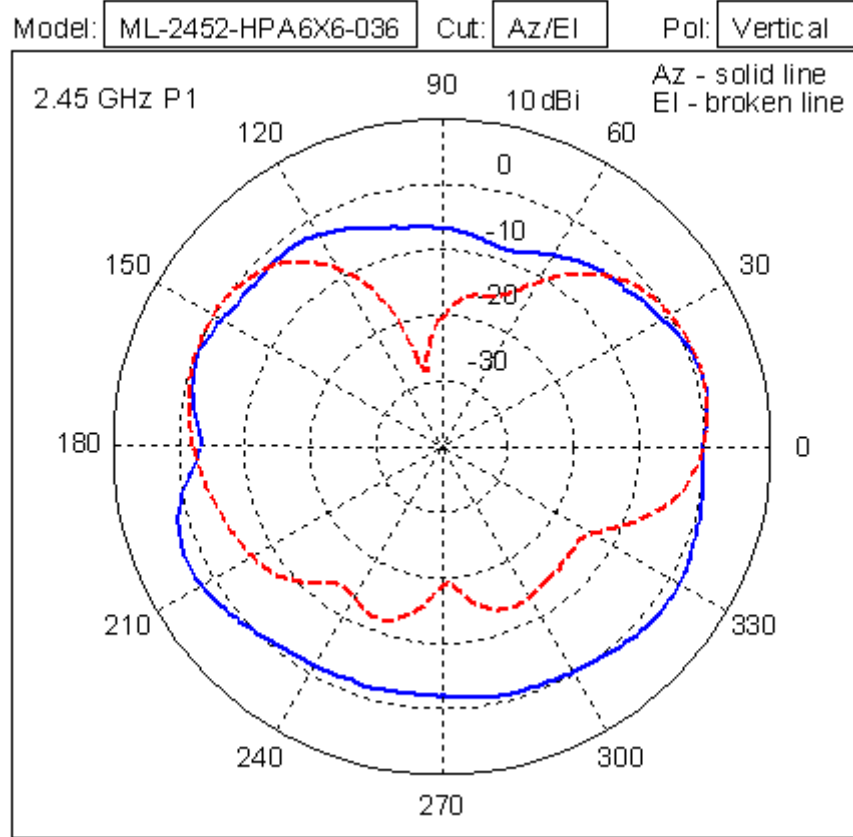

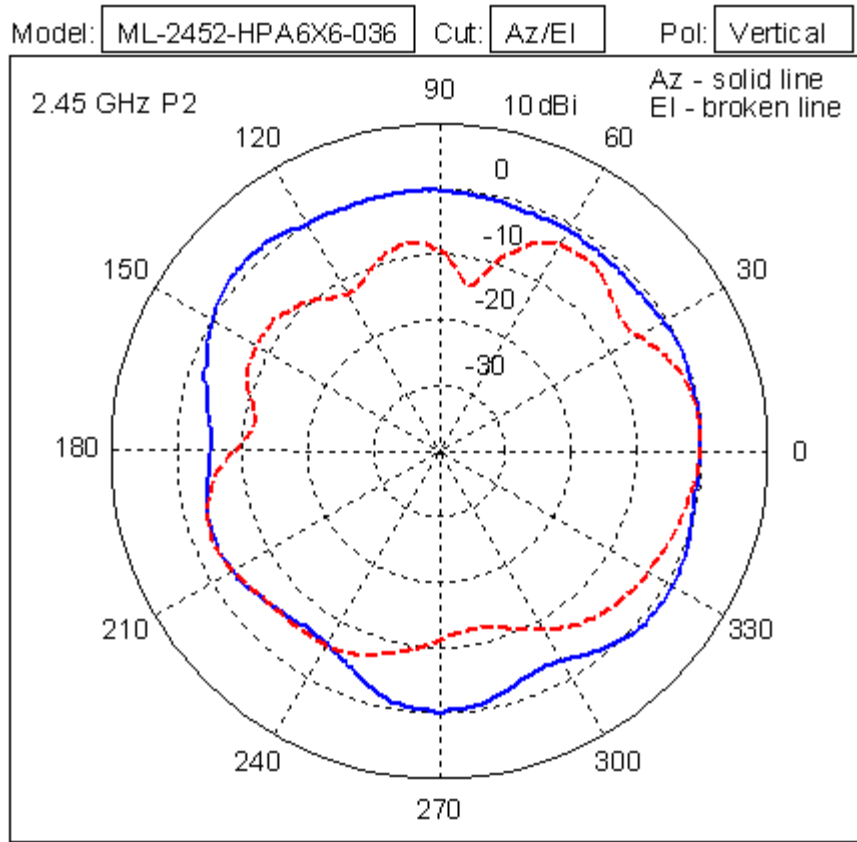

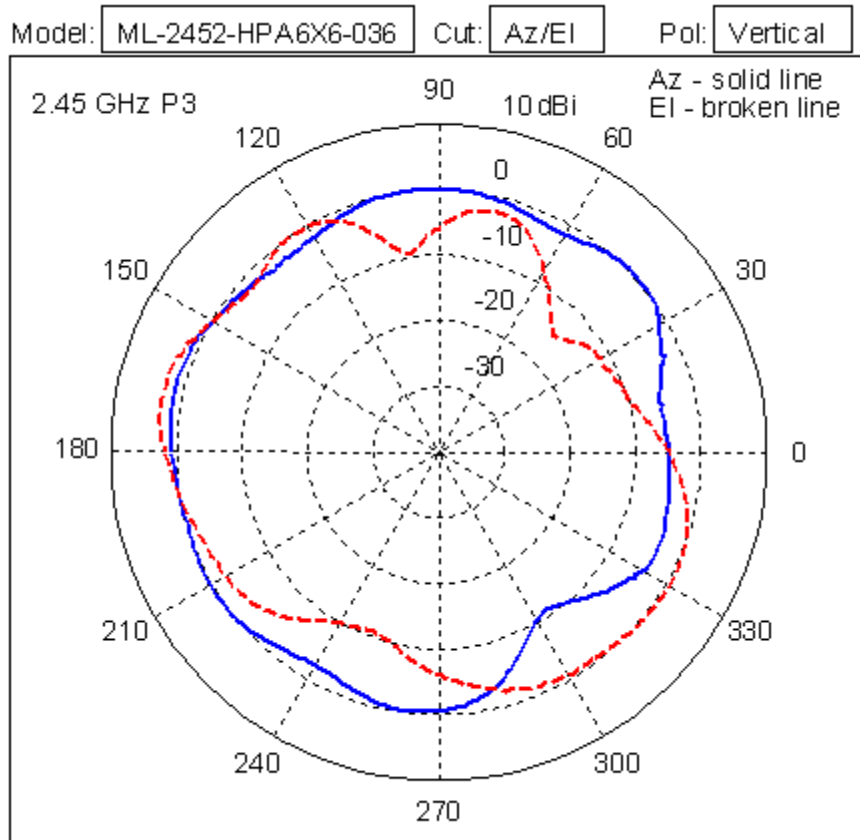
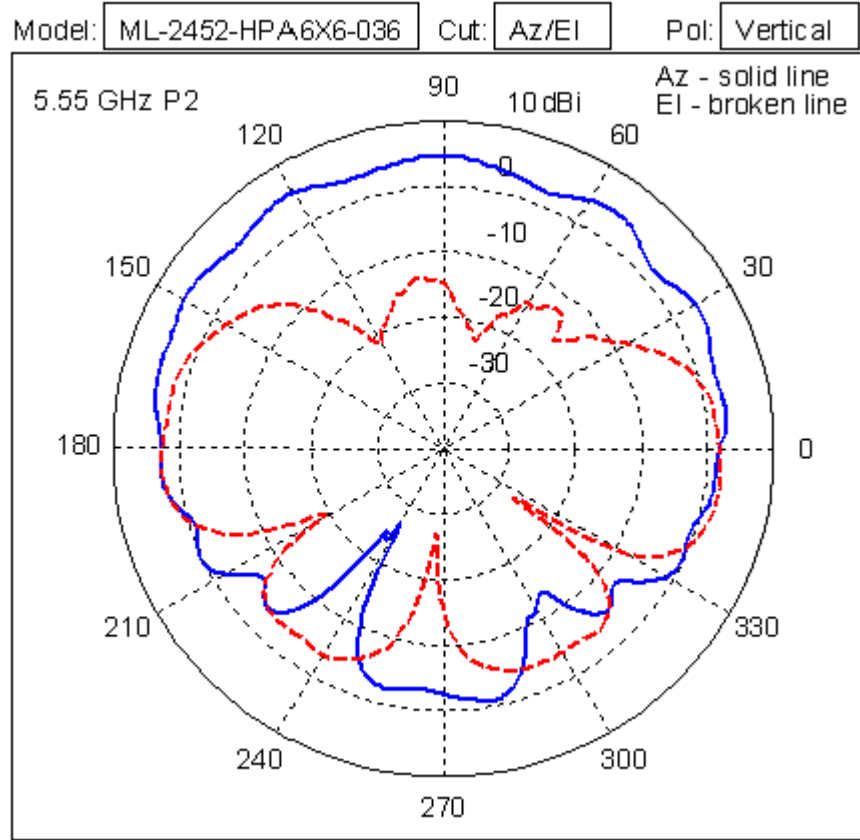

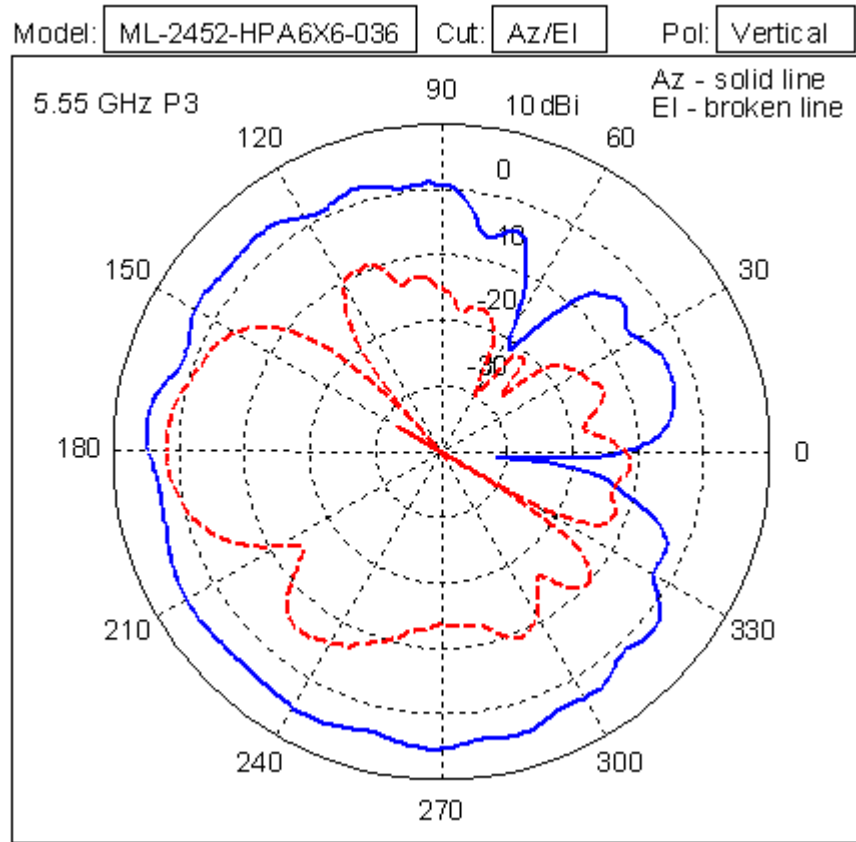

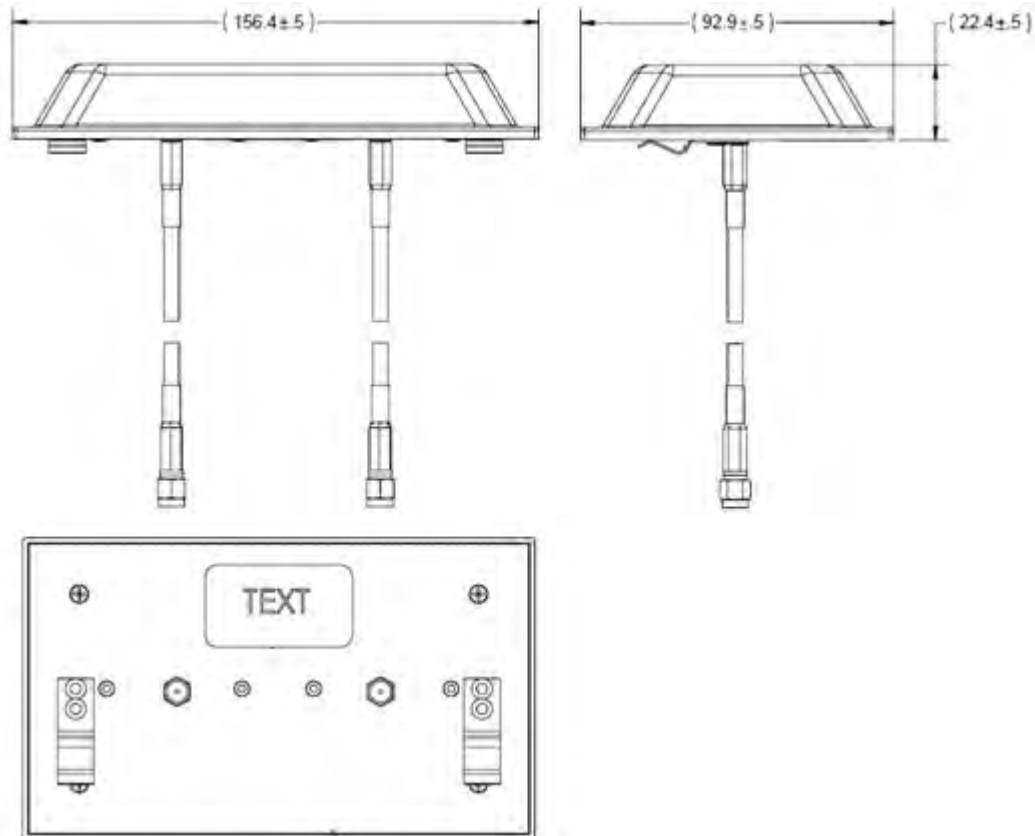

**5.1.13 ML-2452-PTA2M2-036 802.11ABG 2-Port Patch Array, RP-SMA Male**

<i>Type</i>	Two-port, dual-band omni patch array
<i>Frequency</i>	2400-2500/4900-5990 MHz
<i>Max Gain (dBi)</i>	4.0 /5.0
<i>Polarization</i>	Linear, Vertical
<i>Azimuth</i>	3 dB Beamwidth: 360 degrees (2.4 GHz) 3 dB Beamwidth: 360 degrees (5 GHz)
<i>Elevation</i>	3 dB Beamwidth: 60 degrees (2.4 GHz) 3 dB Beamwidth: 60 degrees (5 GHz)
<i>Cable Length</i>	91.4 cm
<i>Cable Type</i>	RG-58
<i>Connector Type</i>	RP-SMA Male
<i>Antenna Plenum Rated</i>	No
<i>Cable Plenum Rated</i>	Yes
<i>Outdoor Rated</i>	No
<i>Weight</i>	0.5 lbs
<i>Storage Temp Range (C)</i>	-30 / +70
<i>Operation Temp Range (C)</i>	-30 / +70

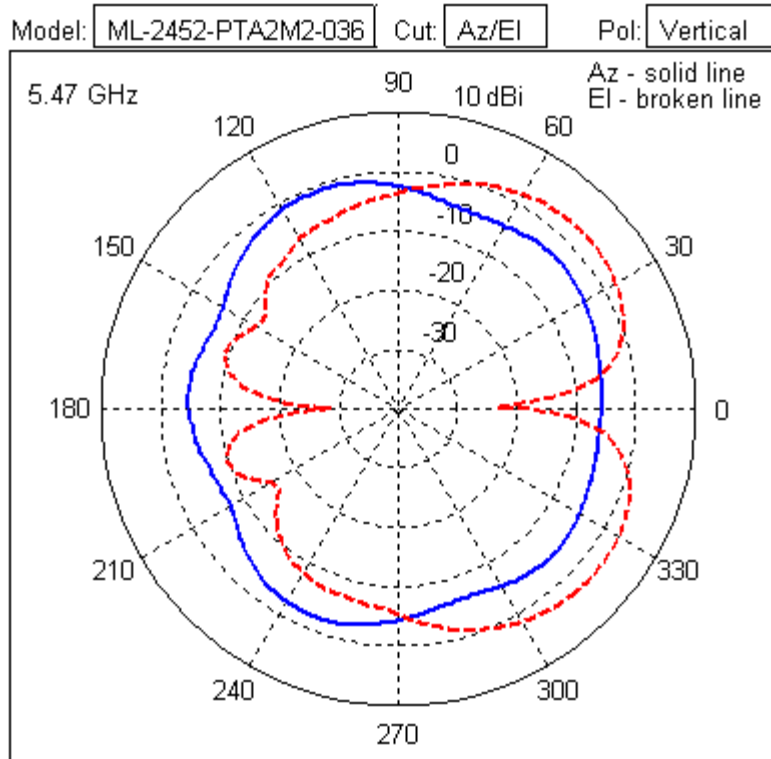
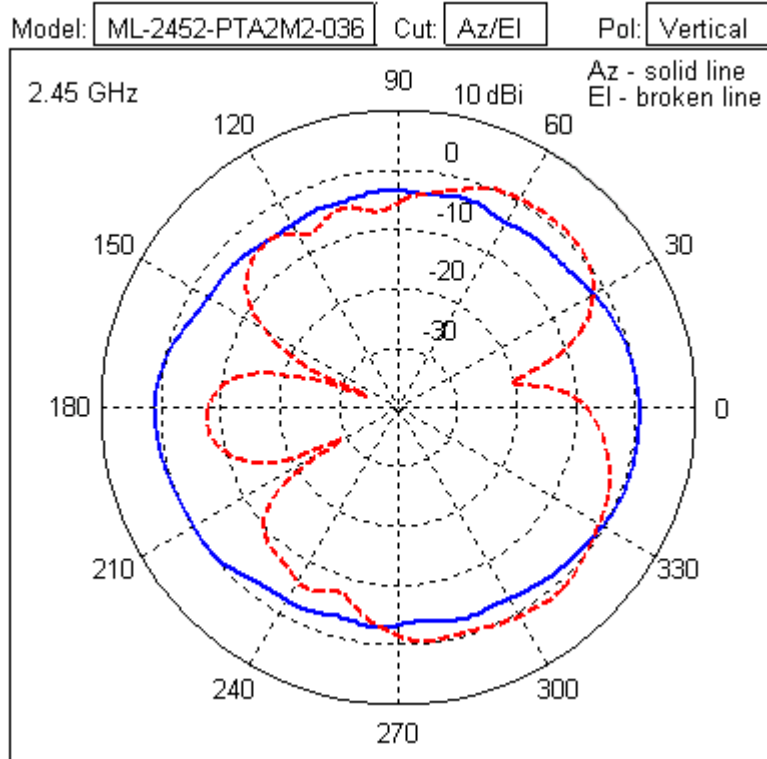

### 5.1.14 ML-2452-PTA6M6-036 Six-Port Omnidirectional Panel, RP-SMA Male

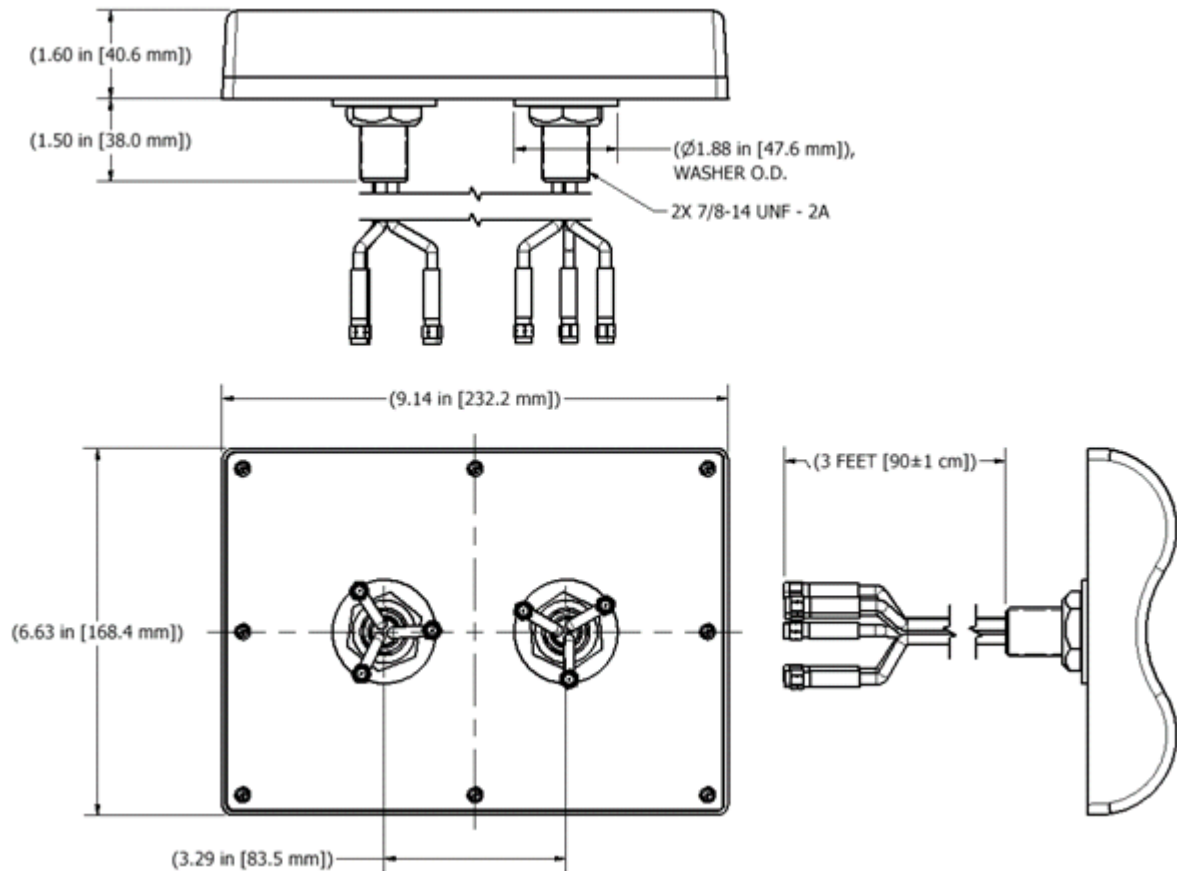

Type	6-Port Dual Band Omnidirectional Panel
Frequency	2400-2500/4900-5900 MHz
Max Gain (dBi)	4.0 /5.0
Polarization	Linear, Vertical
Azimuth	3 dB Beamwidth: 360 degrees (2.4 GHz) 3 dB Beamwidth: 360 degrees (5 GHz)
Elevation	3 dB Beamwidth: 55 degrees (2.4 GHz) 3 dB Beamwidth: 45 degrees (5 GHz)
Cable Length	90 cm
Cable Type	RG-58
Connector Type	RP-SMA Male
Antenna Plenum Rated	N/A
Cable Plenum Rated	Yes
Outdoor Rated	No

Weight	1.5 lbs
Storage Temp Range (C)	-40 / +80
Operation Temp Range (C)	-30 / +70

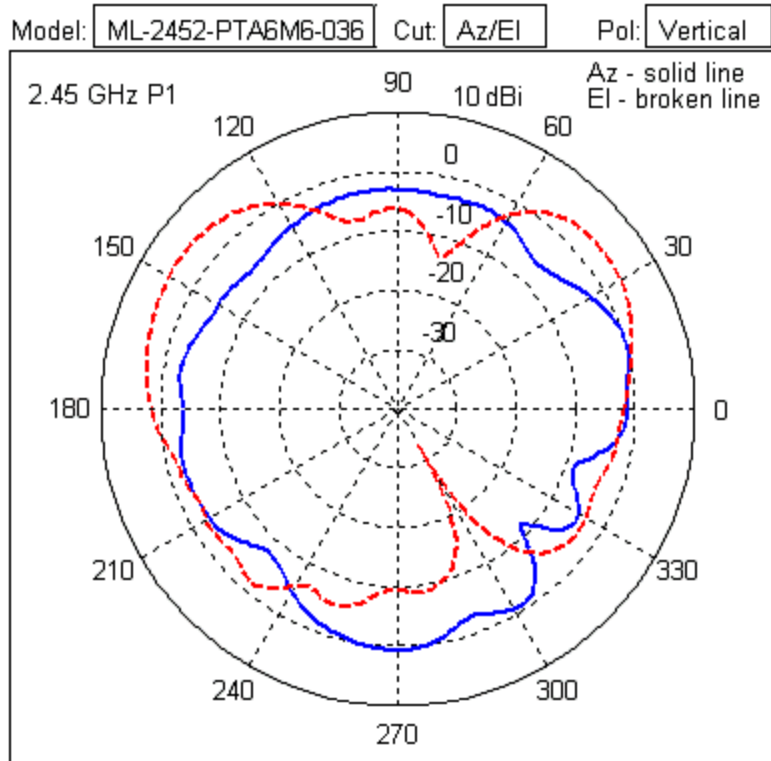

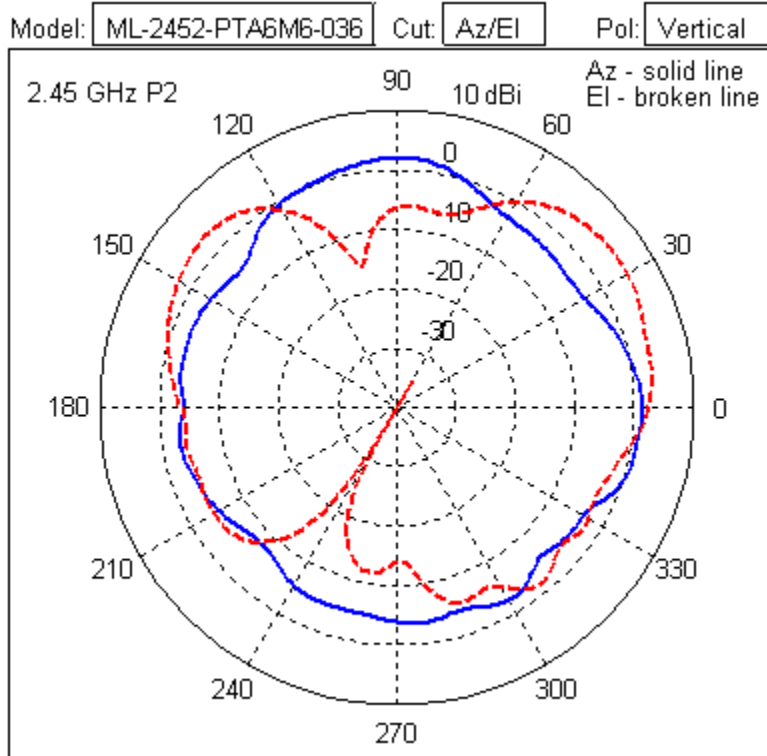
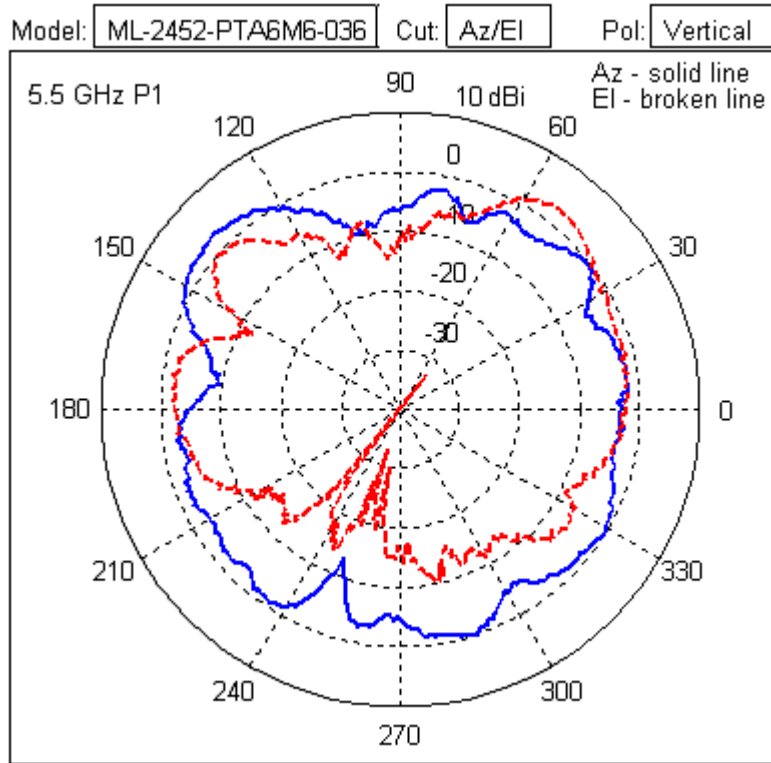

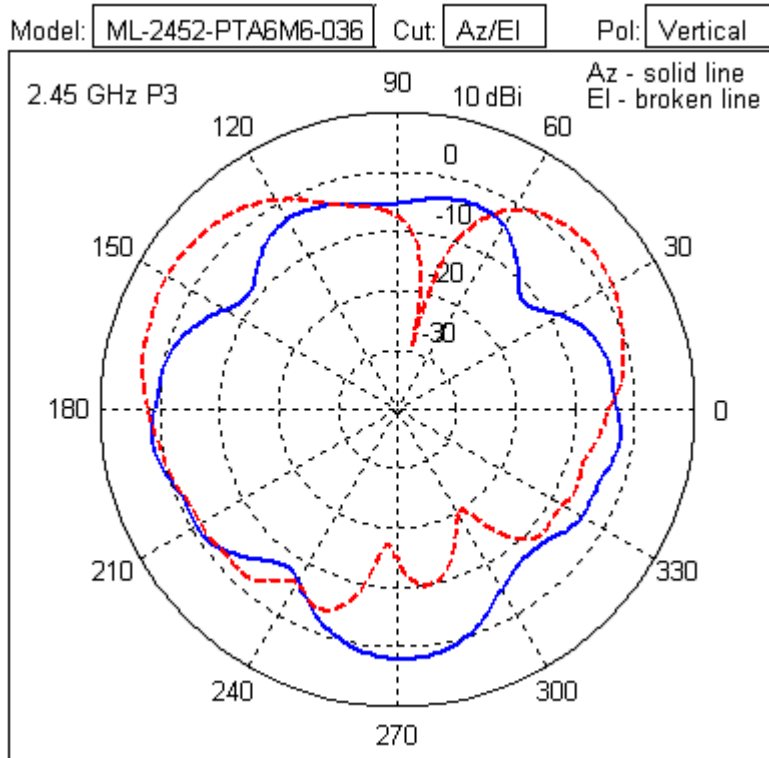
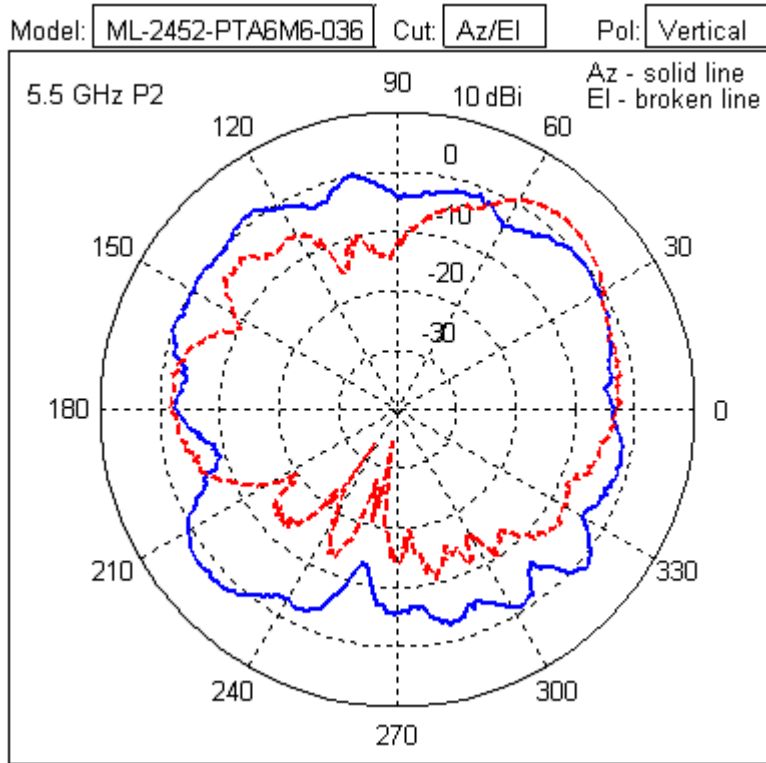

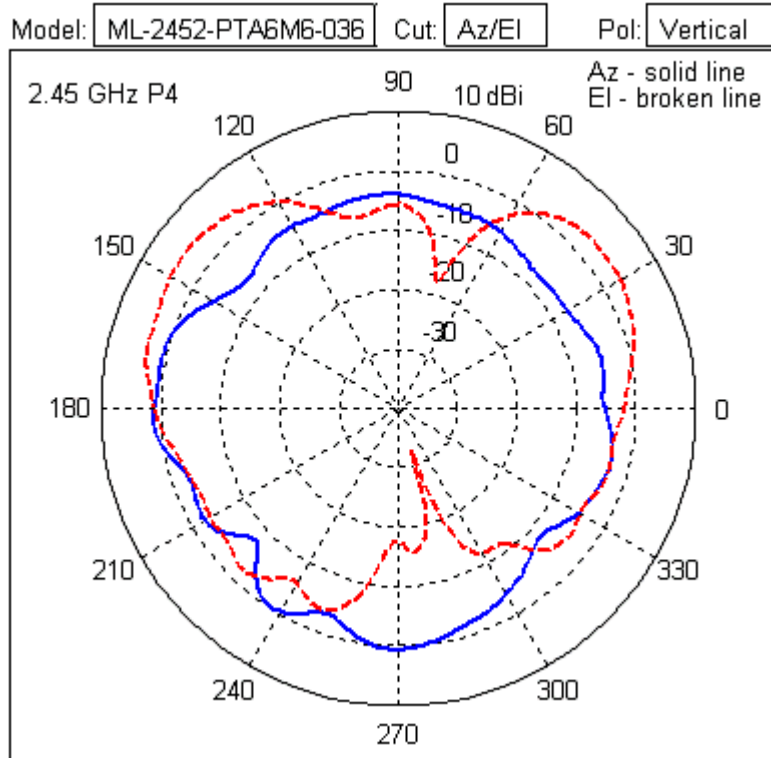
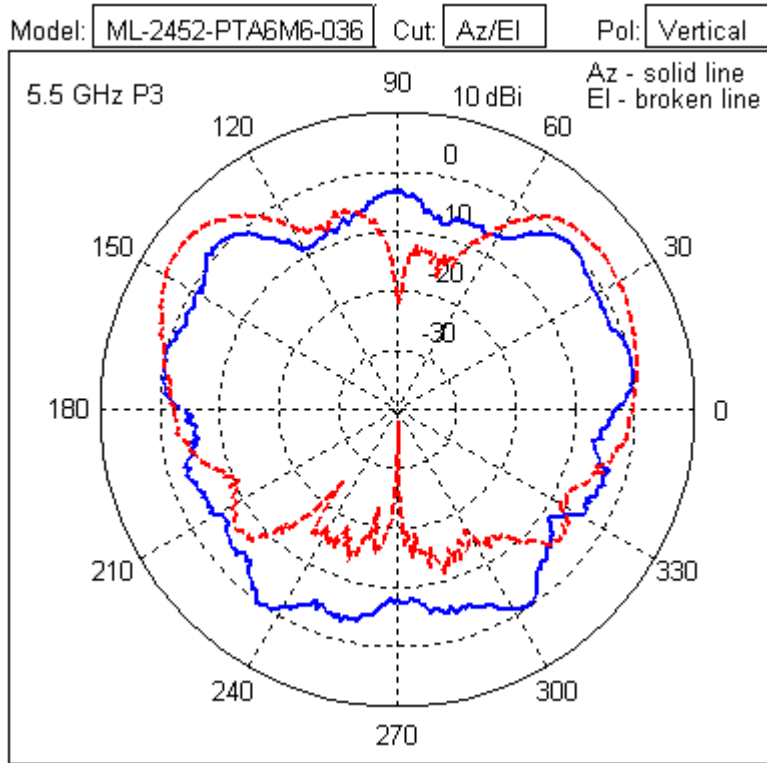

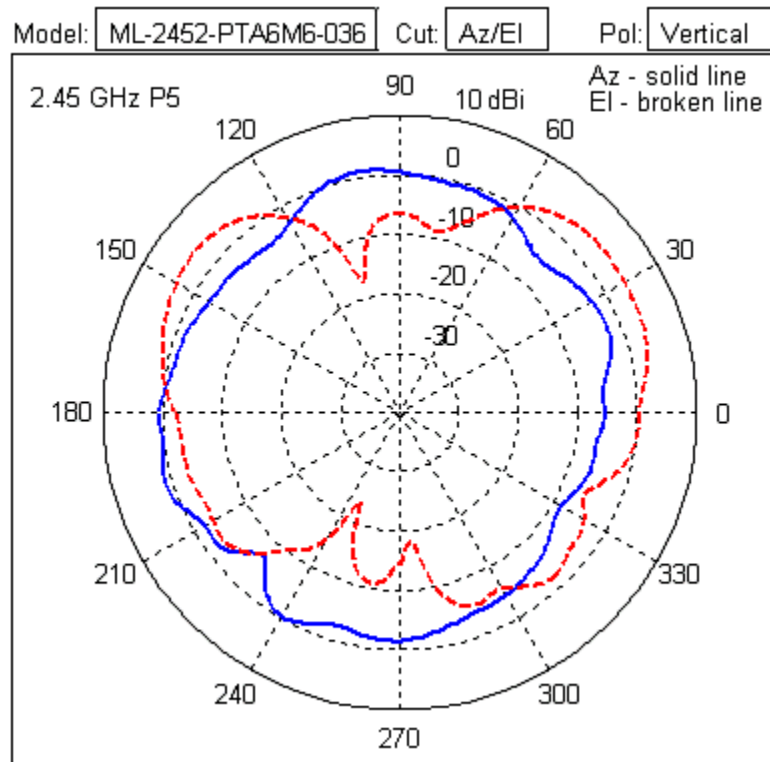
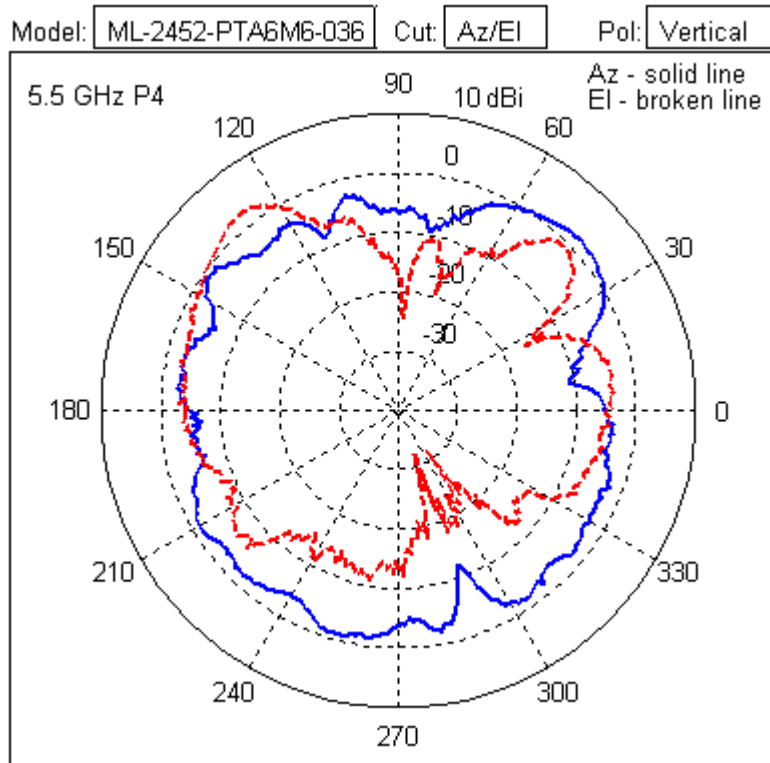



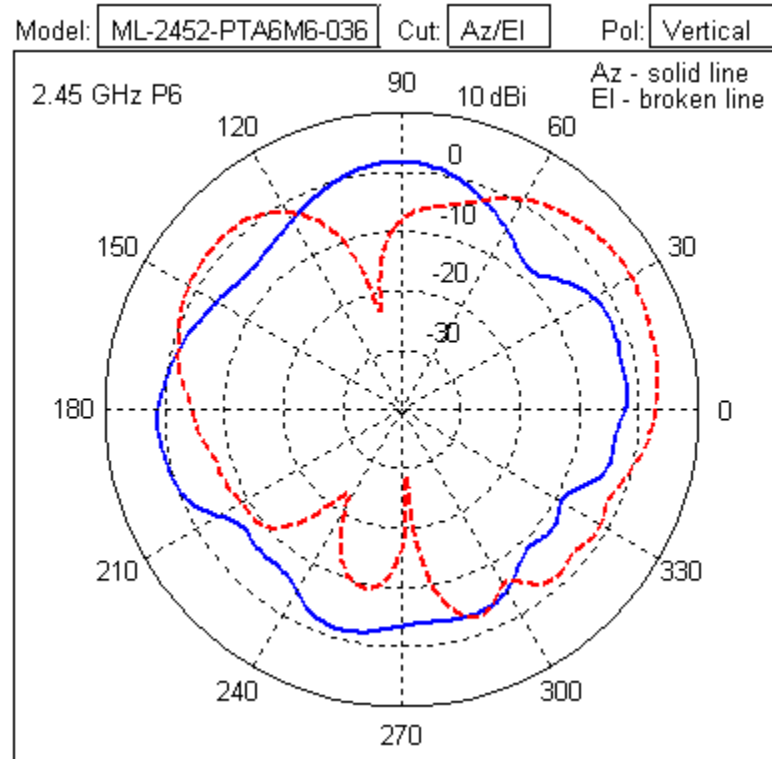
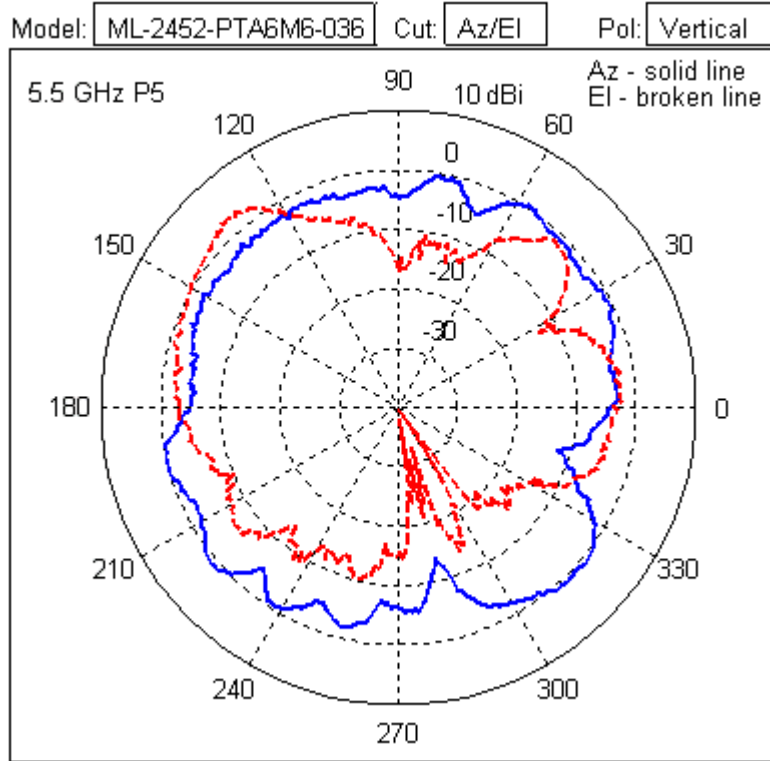

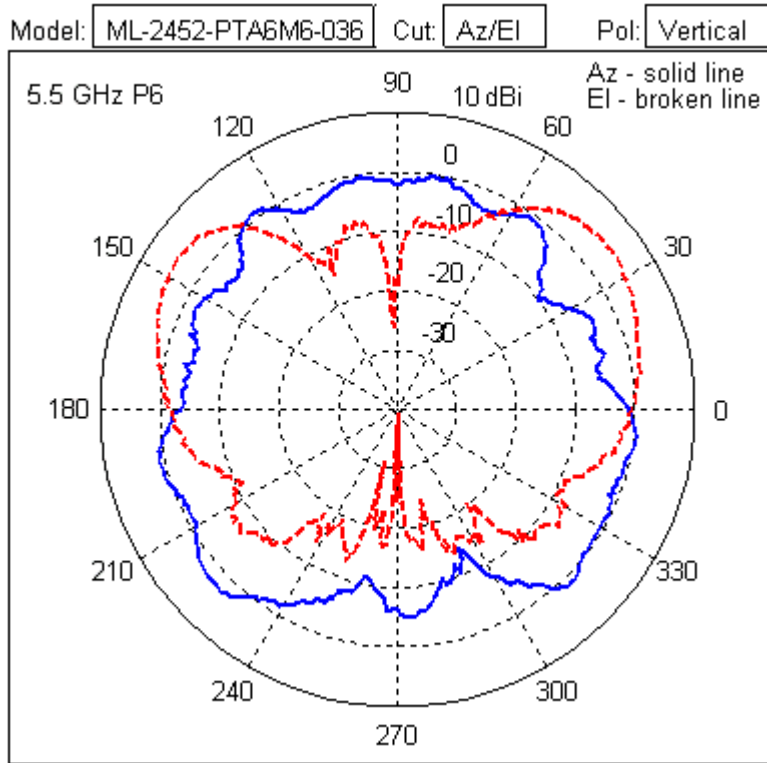

### 5.1.15 ML-2452-PTA6M6-1 Six-Port PIFA Array, RP-SMA Male

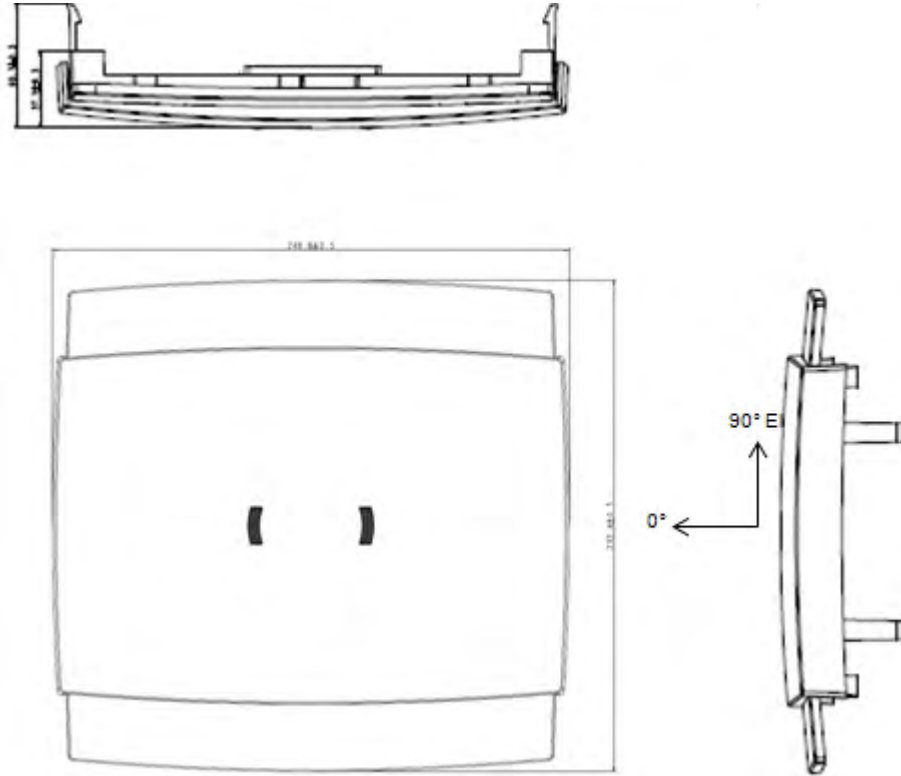

Type	6-Port PIFA Array
Frequency	2400-2500/5150-5950 MHz
Max Gain (dBi)	3.5/4.0
Polarization	Linear, Vertical
Azimuth	3 dB Beamwidth: 360 degrees (2.4 GHz) 3 dB Beamwidth: 360 degrees (5 GHz)
Elevation	3 dB Beamwidth: 180 degrees (2.4 GHz) 3 dB Beamwidth: 180 degrees (5 GHz)
Cable Length	8.0 cm
Cable Type	1.37 mm coax
Connector Type	RP-SMA Male x 6
Antenna Plenum Rated	No
Cable Plenum Rated	No
Outdoor Rated	No
Weight	0.46 kc/s

Storage Temp Range (C)	-40 / +70
Operation Temp Range (C)	-20 / +70

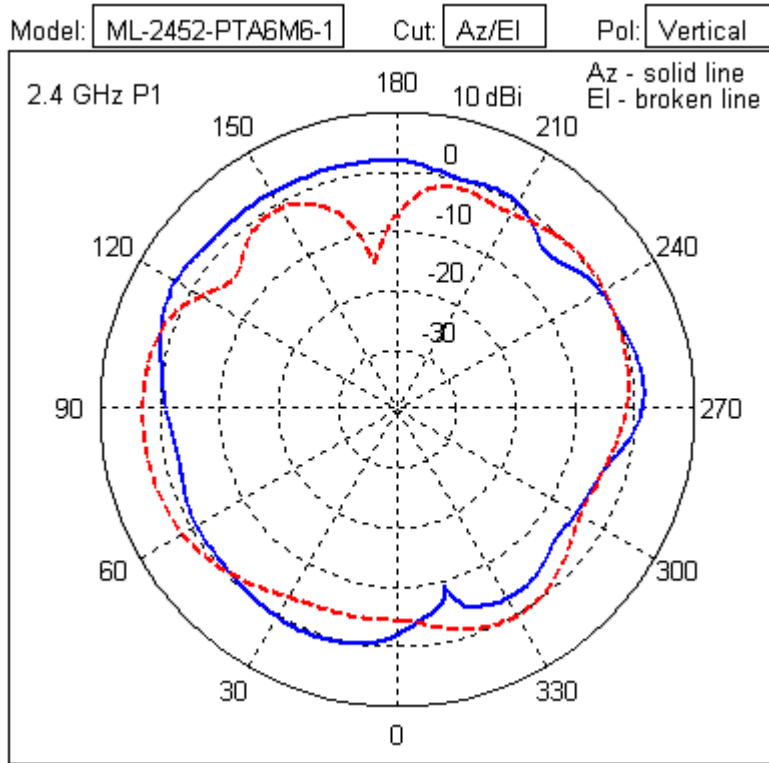

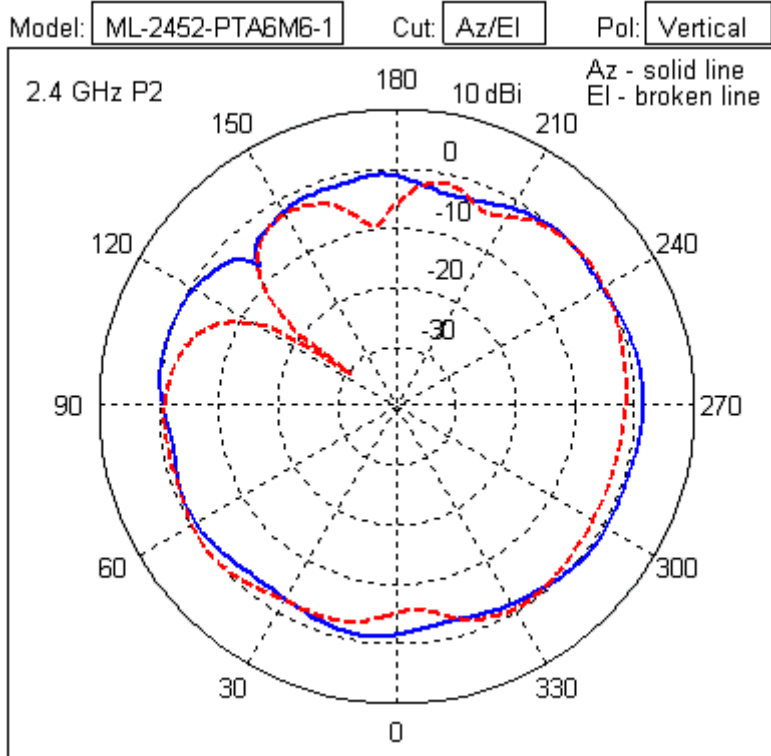
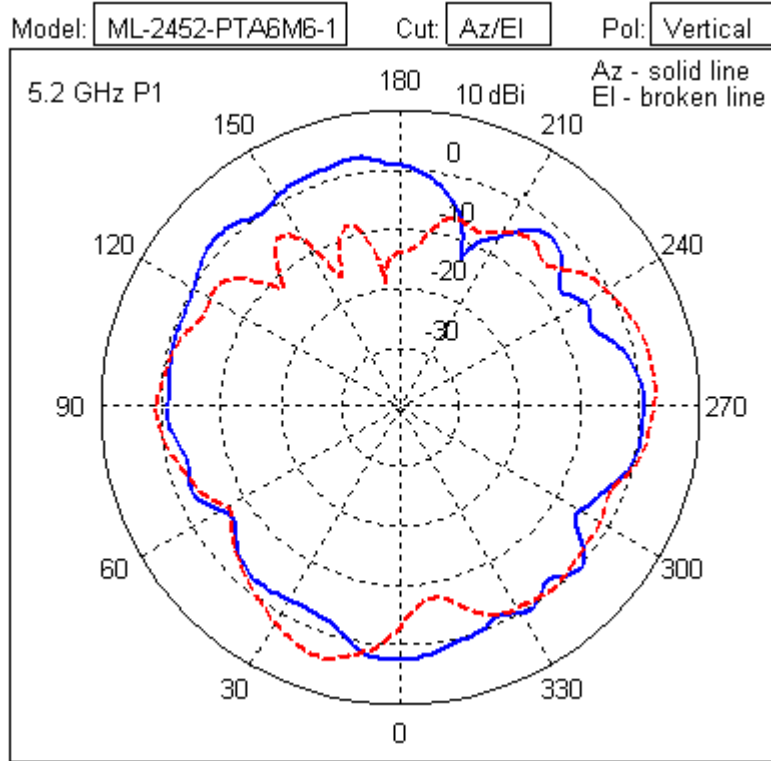

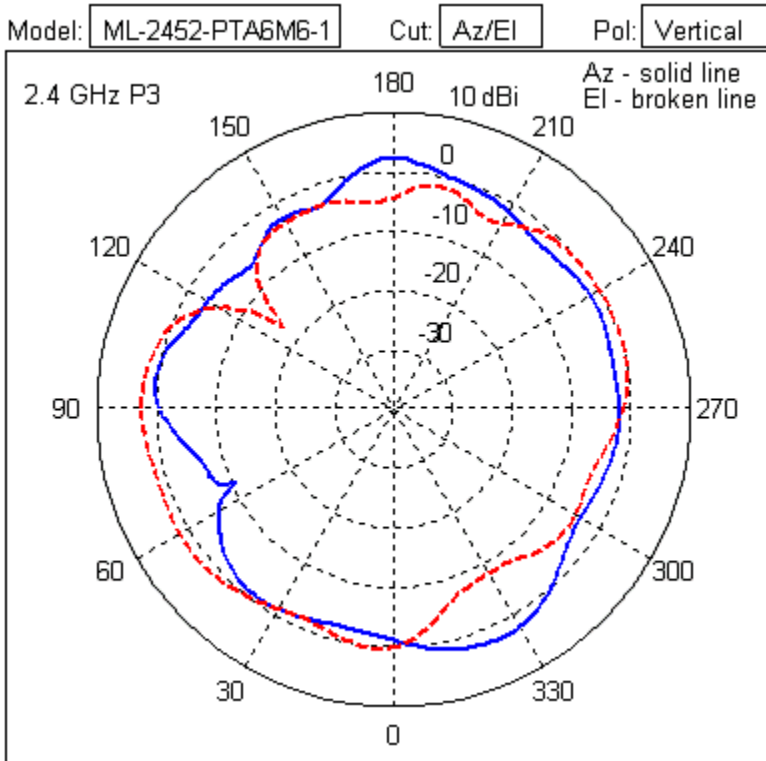
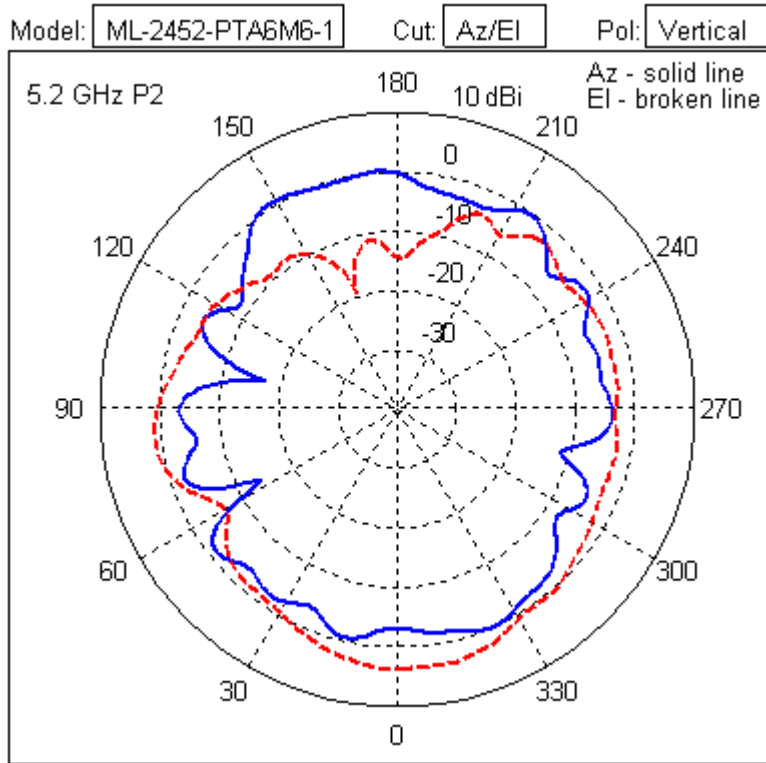

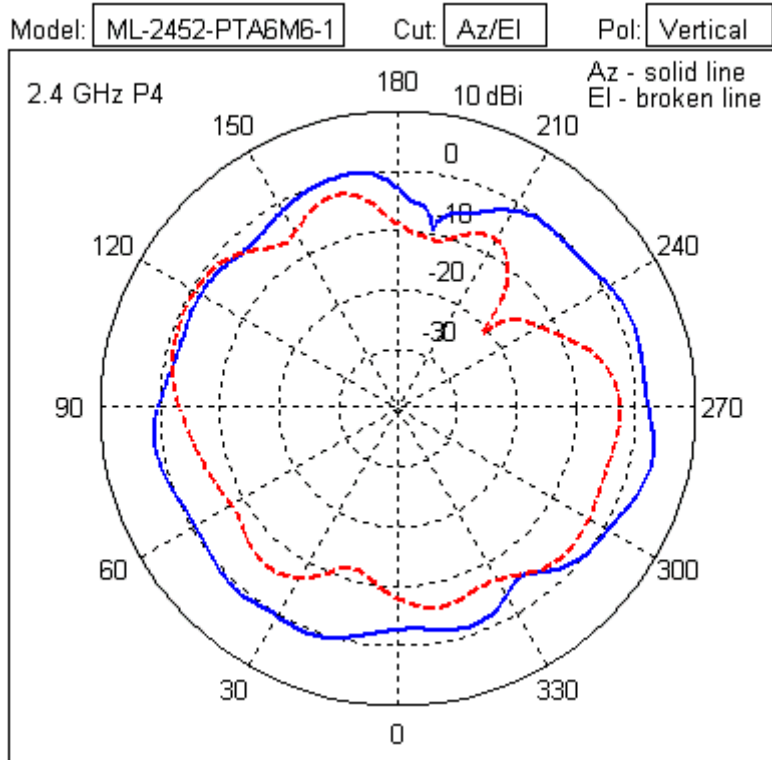
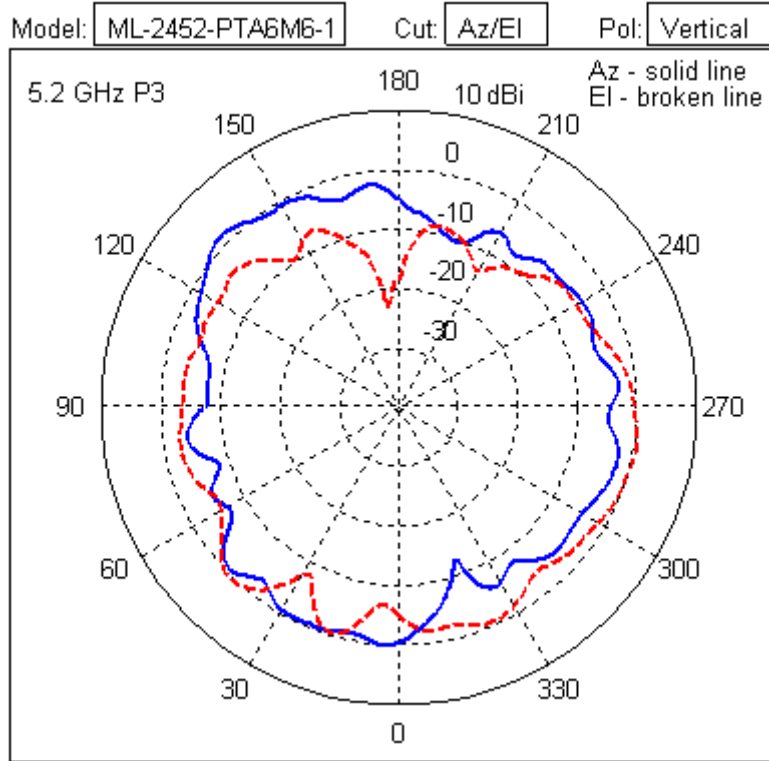

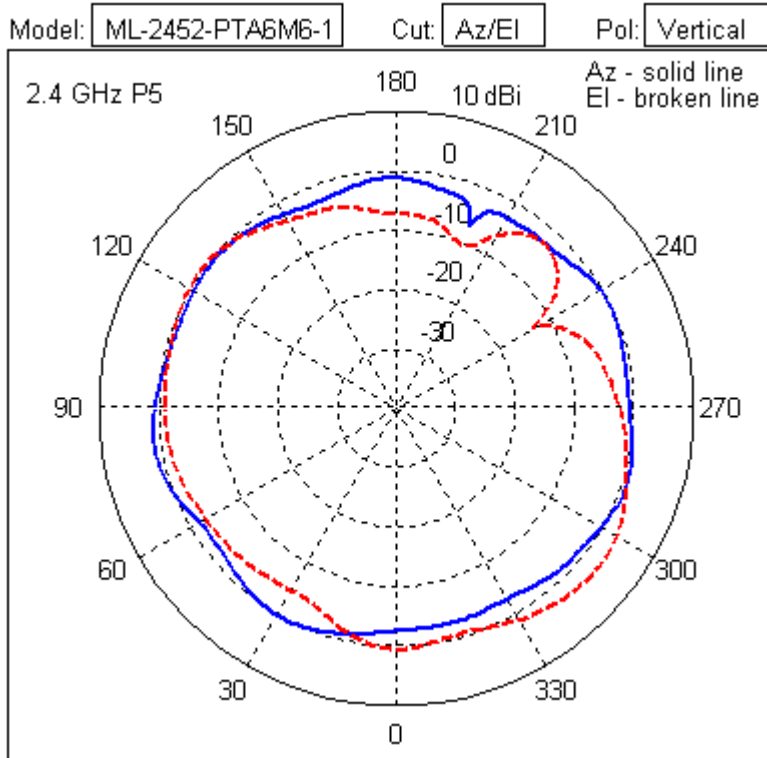
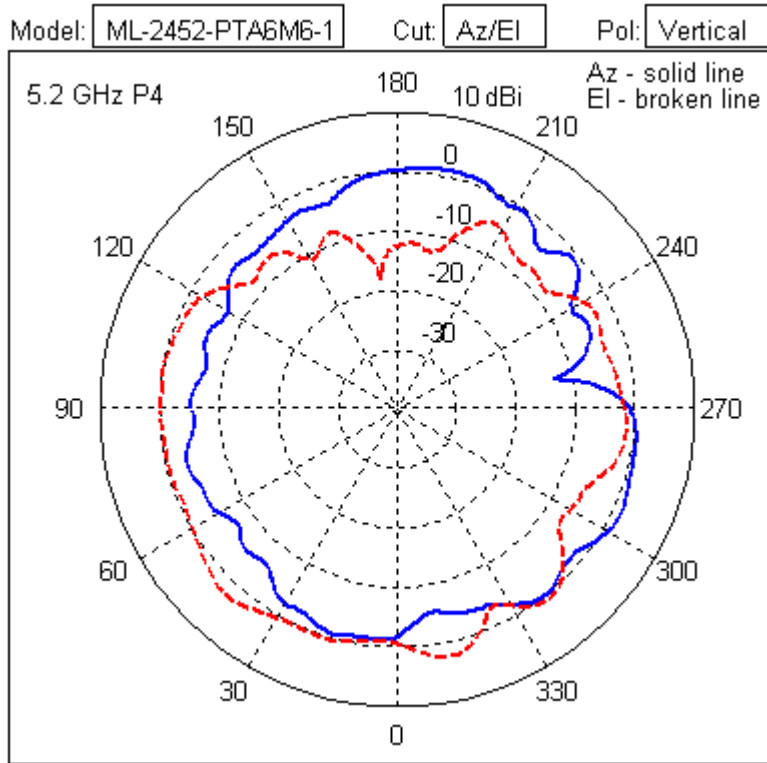



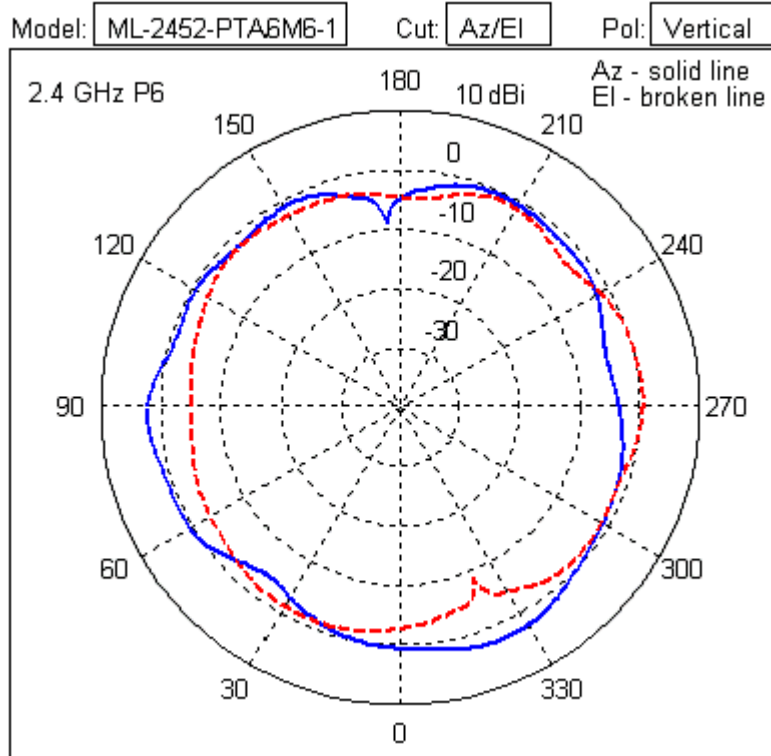
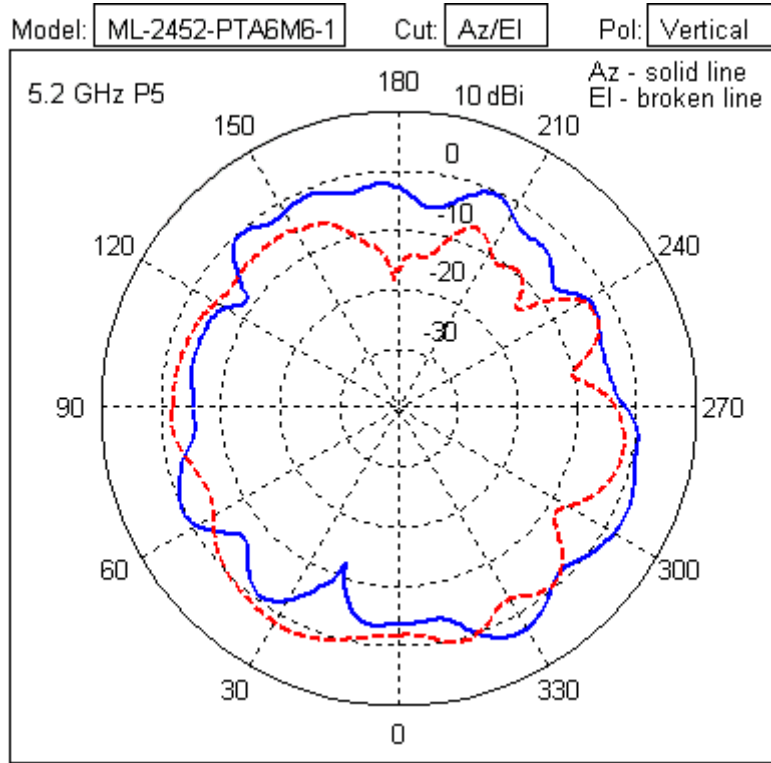

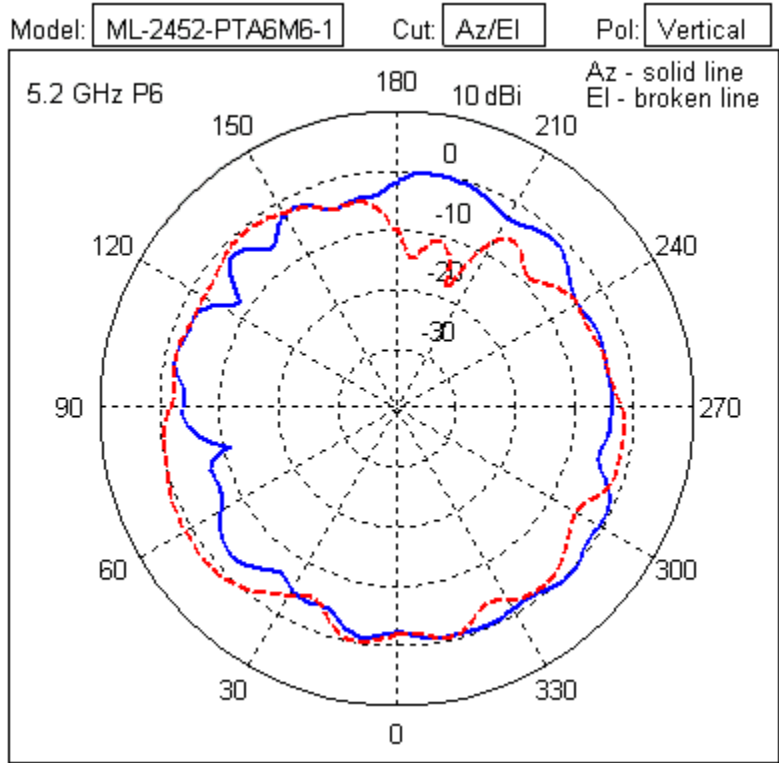

### 5.1.16 ML-2452-HPA6M6-072 11ABGN, 6P DB Omni, 2.0/4.8 dBi, LP, CBL 72, RP - SMA-M

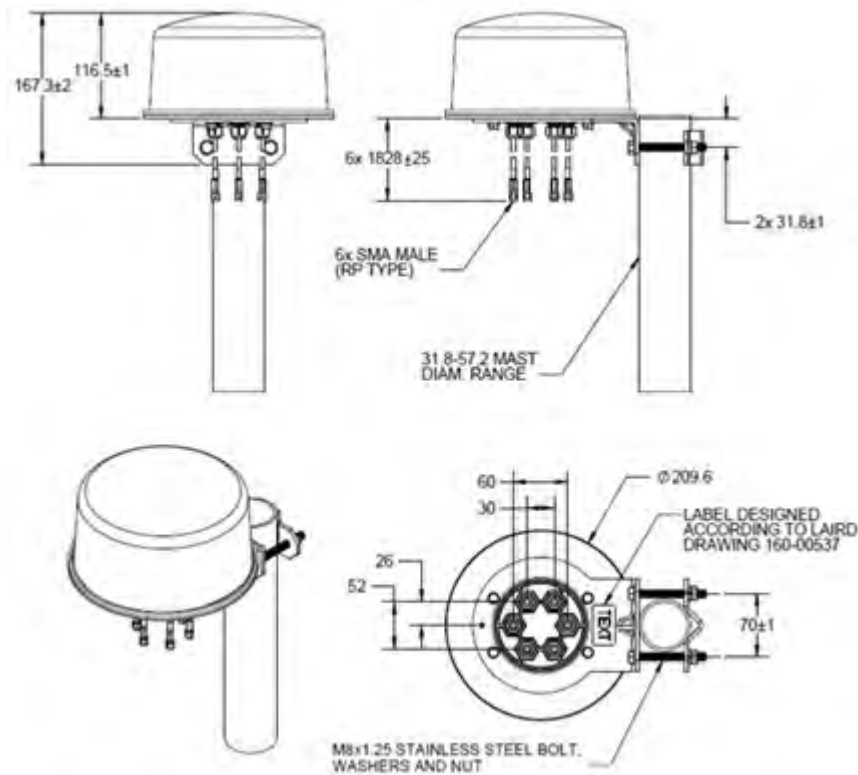

Type	6-Port Dipole Omni Array
Frequency	2400-2500/5150-5875 MHz
Max Gain (dBi)	2.8/6.5
Polarization	Linear, Vertical
Azimuth	3 dB Beamwidth: 360 degrees (2.4 GHz) 3 dB Beamwidth: 360 degrees (5 GHz)
Elevation	3 dB Beamwidth: 66 degrees (2.4 GHz) 3 dB Beamwidth: 30 degrees (5 GHz)
Cable Length	182.0 cm
Cable Type	RG-58
Connector Type	SMA-RP-Male x 6
Antenna Plenum Rated	N/A
Cable Plenum Rated	Yes
Outdoor Rated	Yes
Weight	3.35 lbs

Storage Temp Range (C)	-40 / +85
Operation Temp Range (C)	-30 / +70

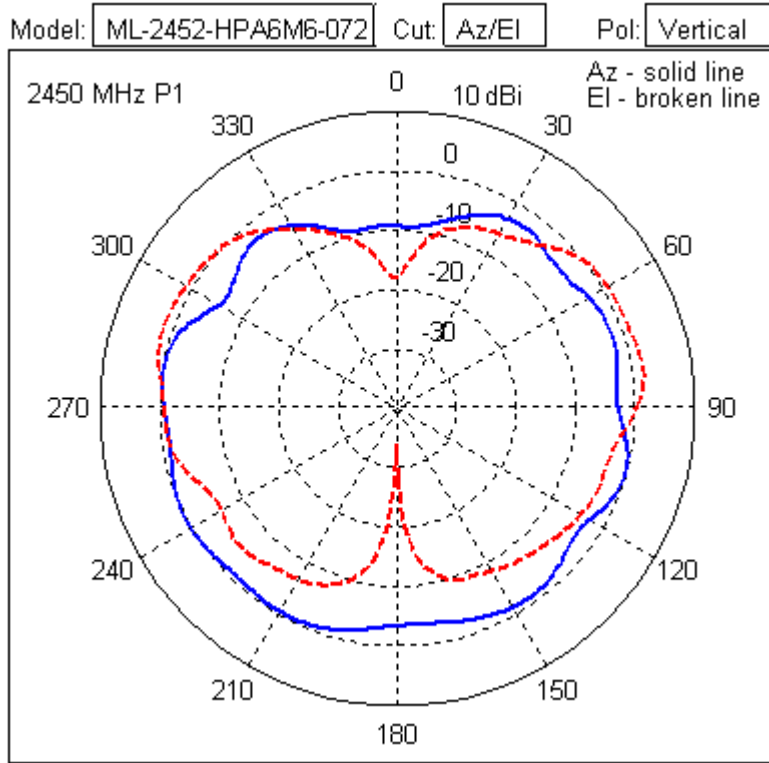

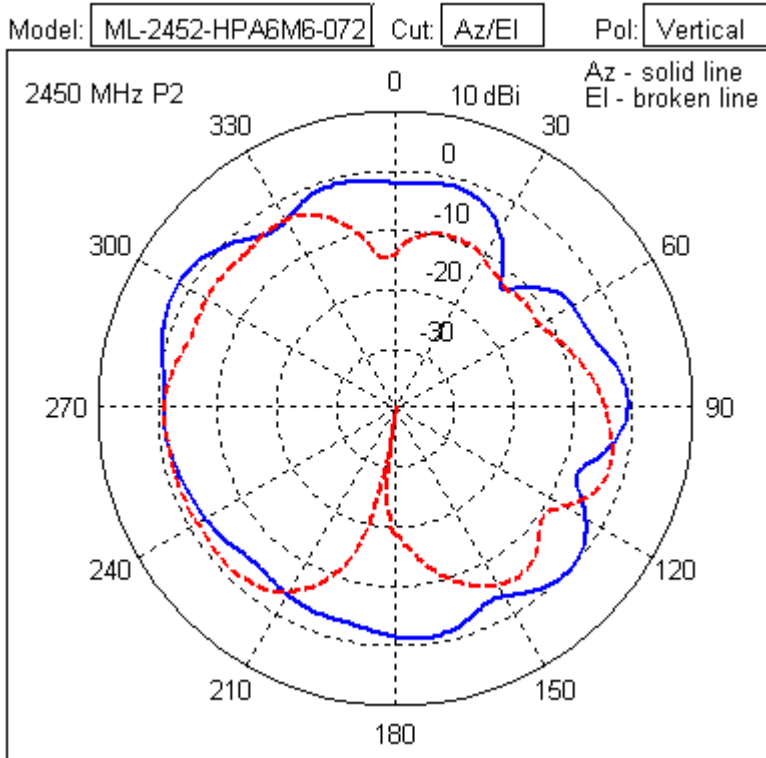
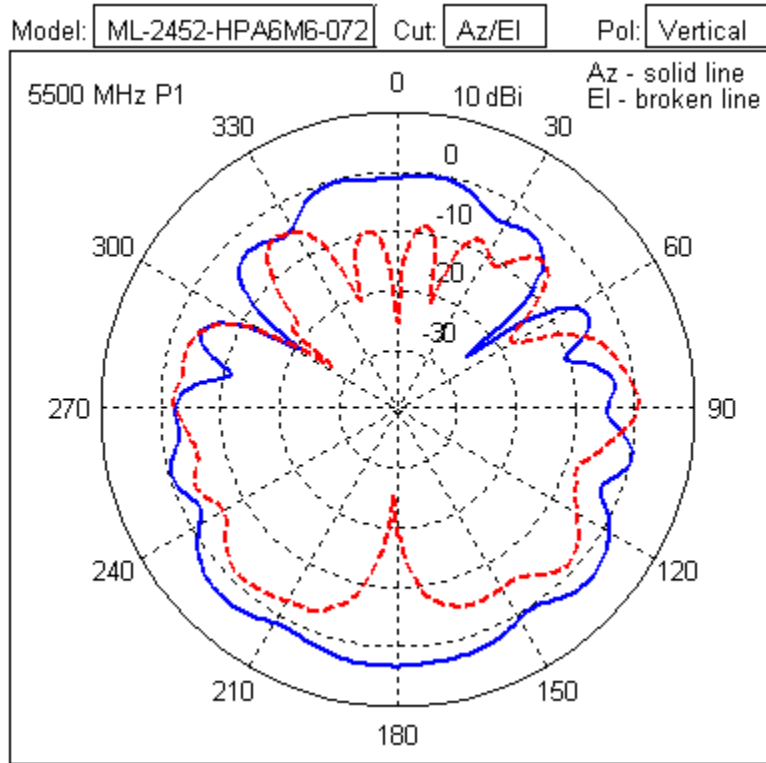

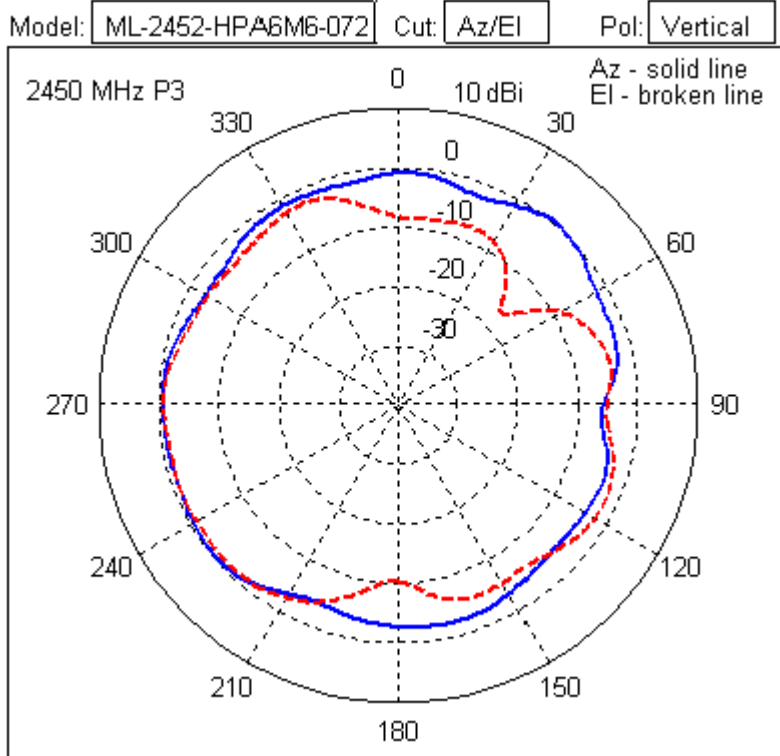
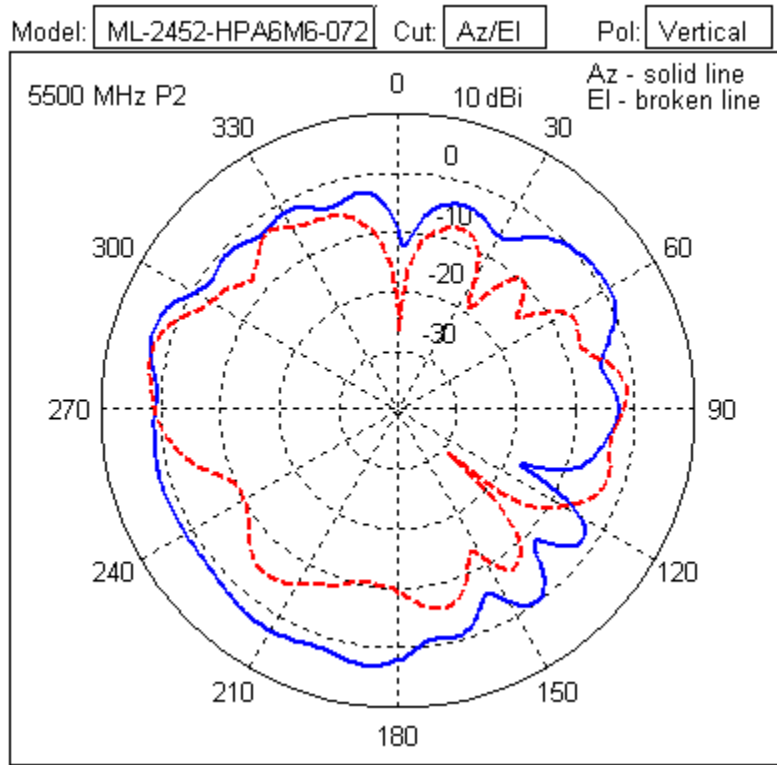

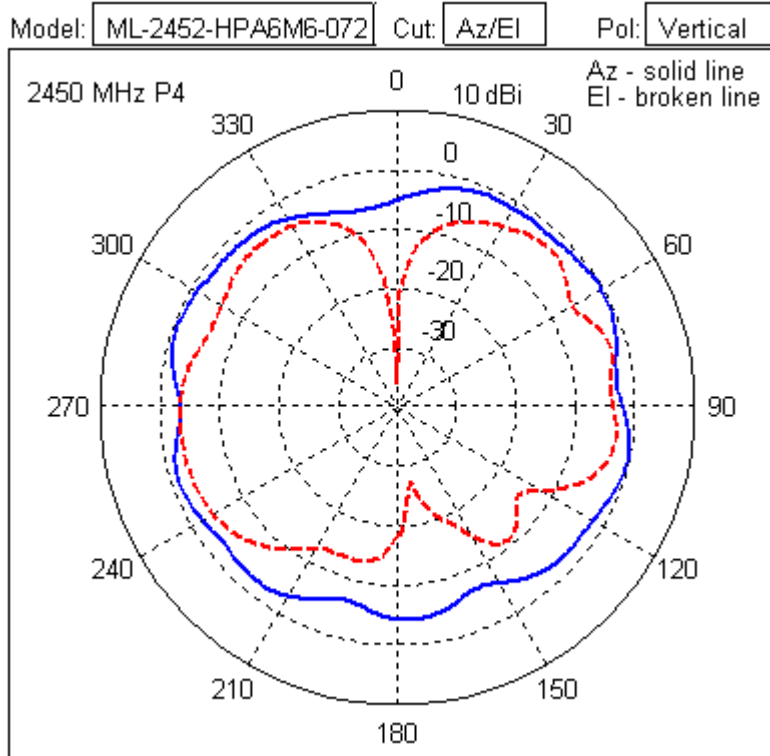
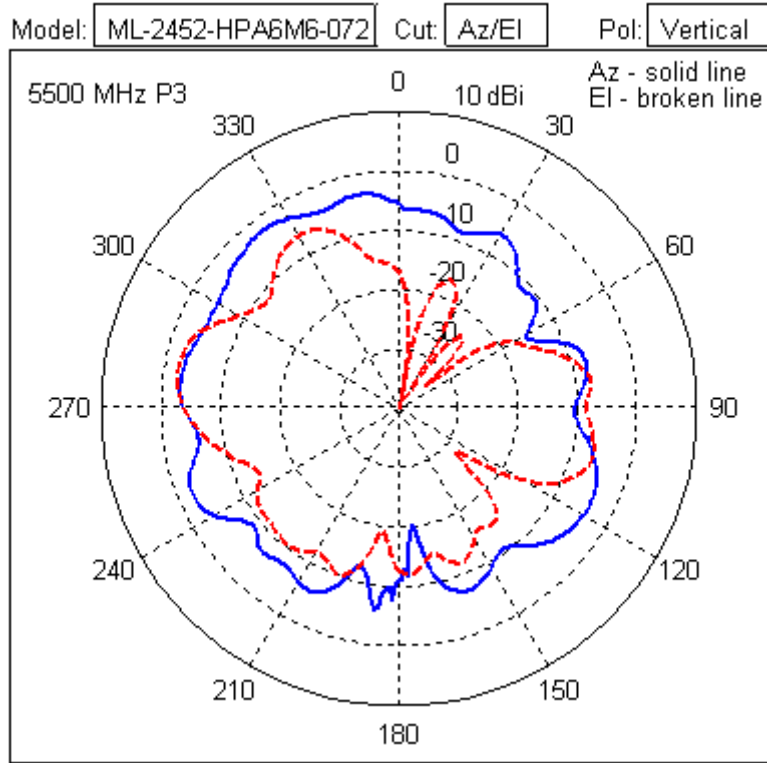

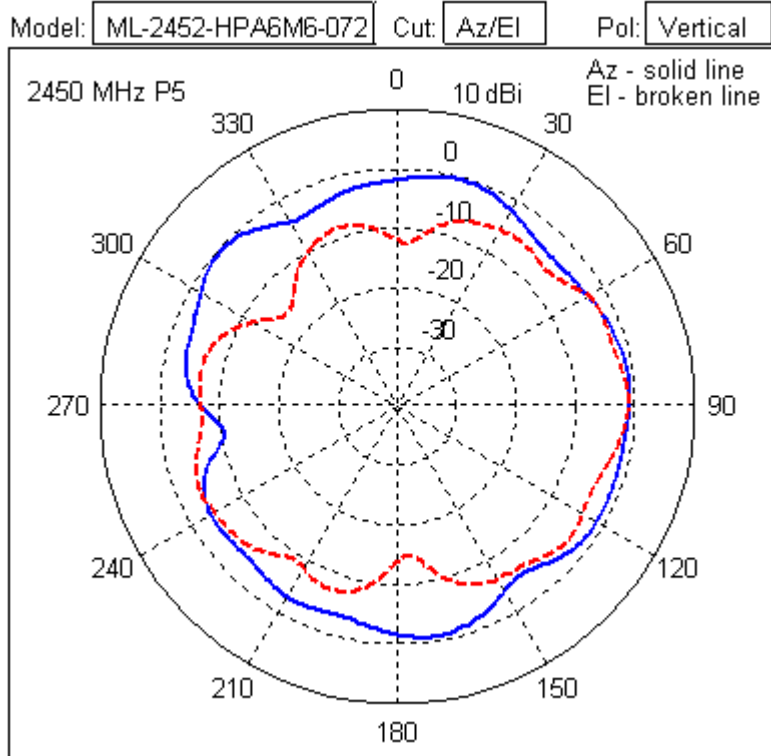
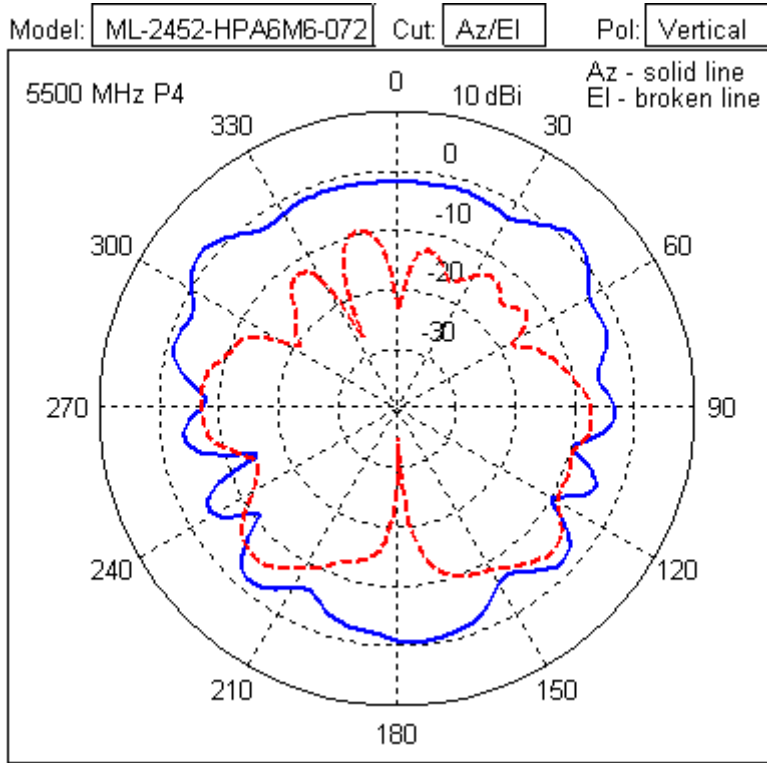



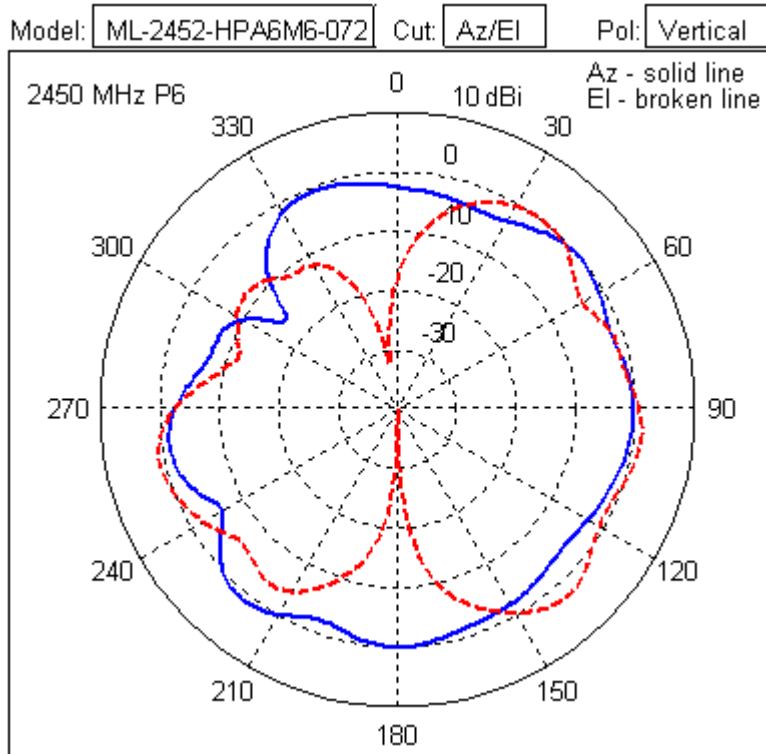
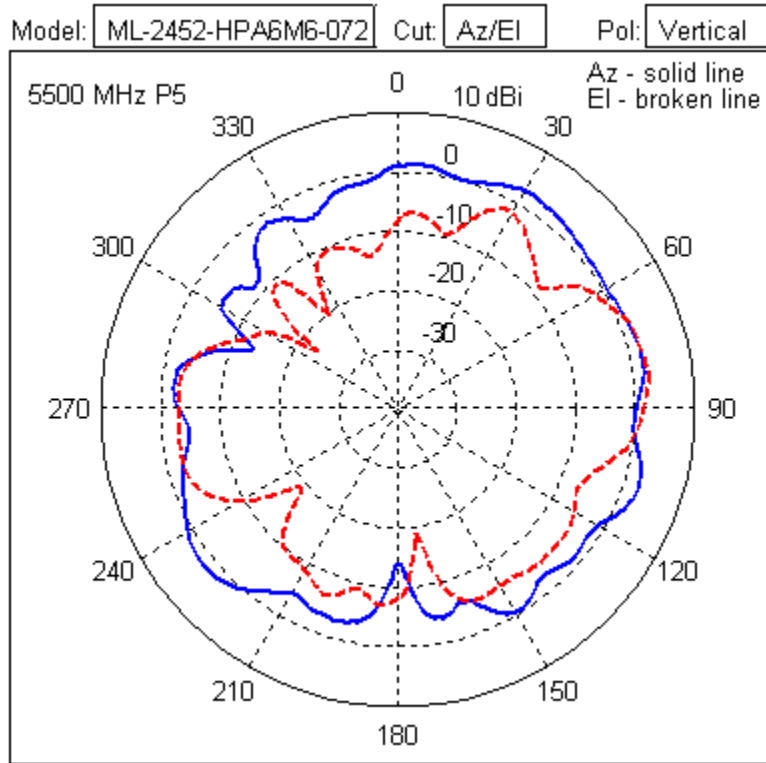

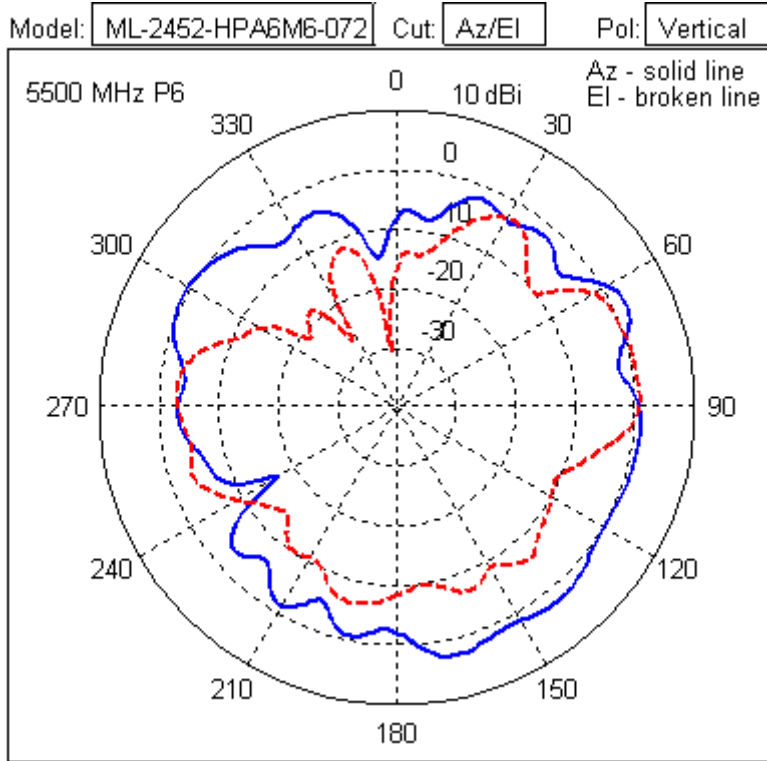

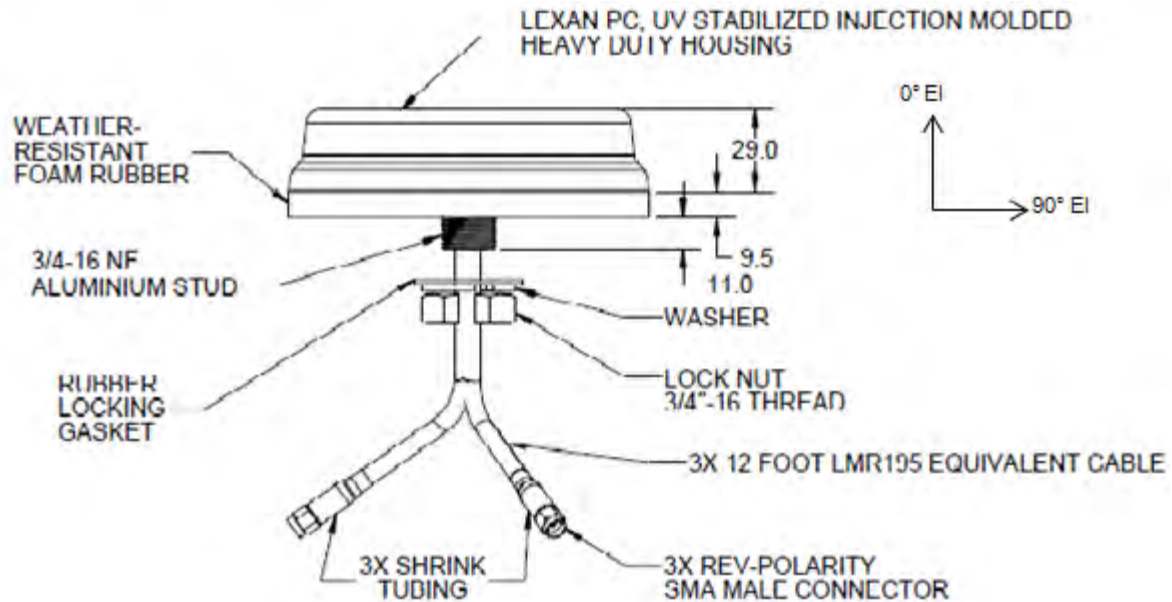
**5.1.17 ML-2452-VMM3M3-036 11ABGN, 3-Port Omni Array, RP-SMA Male x 3**

Type	Dipole
Description	3-Port Omni Array, RP-SMA Male x 3
Frequency	2400-2500/4900-5875 MHz
Max Gain (dBi)	4.5/5.4
Polarization	Linear, Vertical
Azimuth	3 dB Beamwidth: 360 degrees (2.4 GHz) 3 dB Beamwidth: 360 degrees (5 GHz)
Elevation	3 dB Beamwidth: 40 degrees (2.4 GHz) 3 dB Beamwidth: 30 degrees (5 GHz)
Cable Length (inches)	144+/-2.8
Cable Type	LMR195 equiv
Connector Type	RP-SMA Male x 3
Antenna Plenum Rated	N/A
Cable Plenum Rated	No
Outdoor Rated	Yes
Weight	1.34 lbs
Storage Temp Range (C)	-35/ +80
Operation Temp Range (C)	-30/ +80

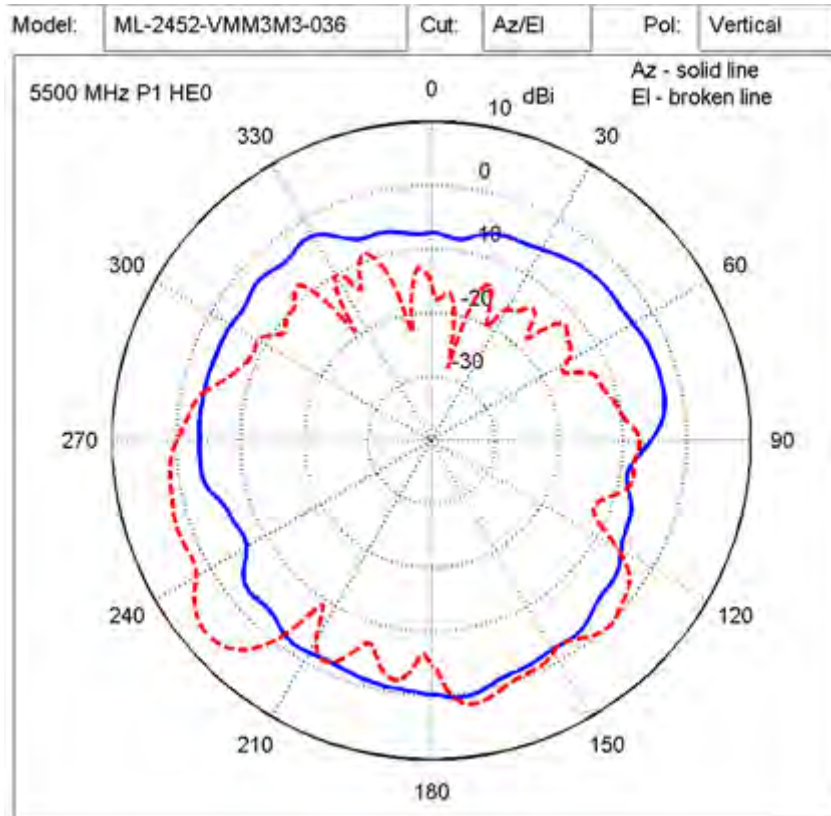
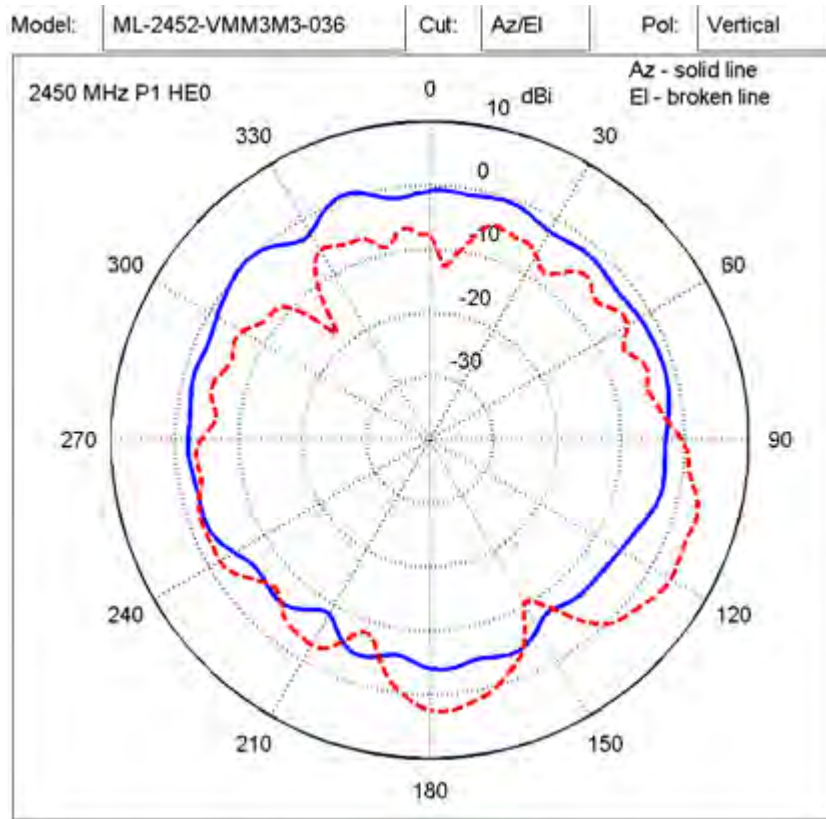

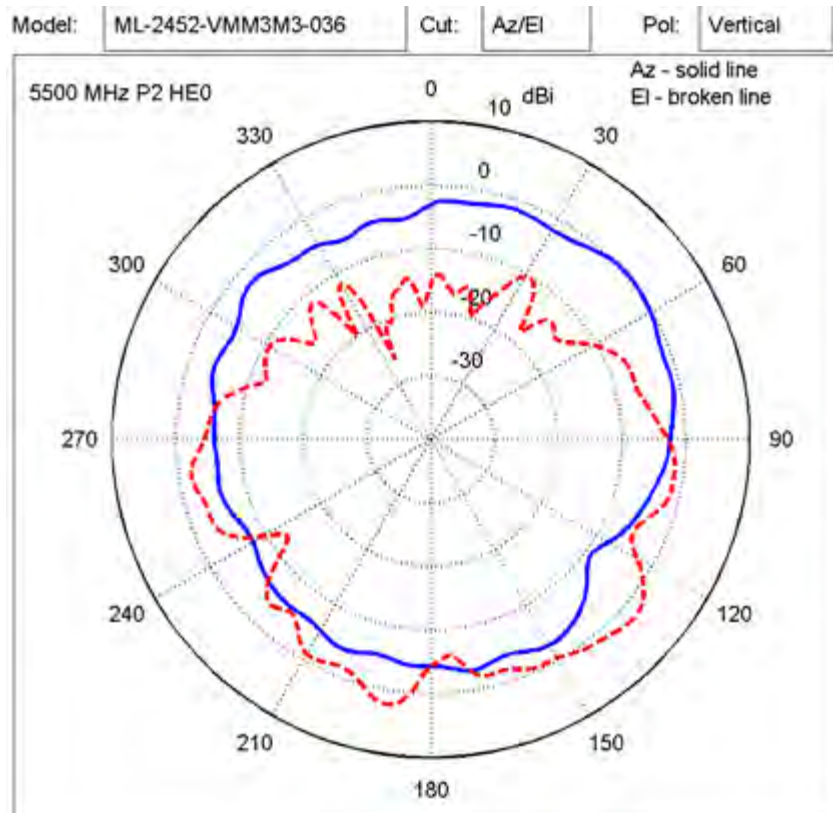
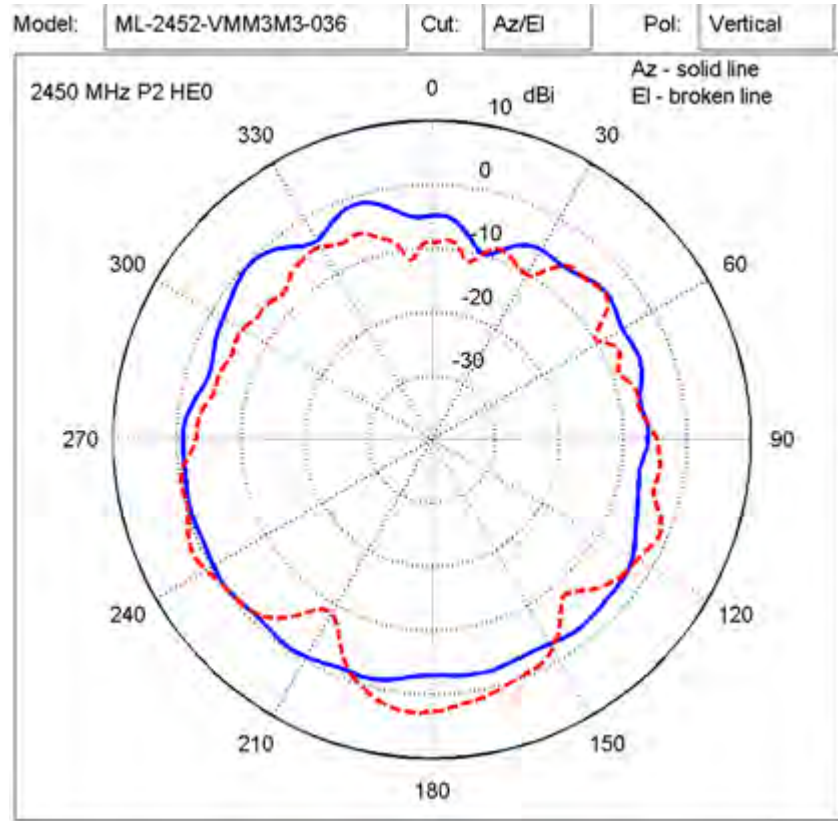

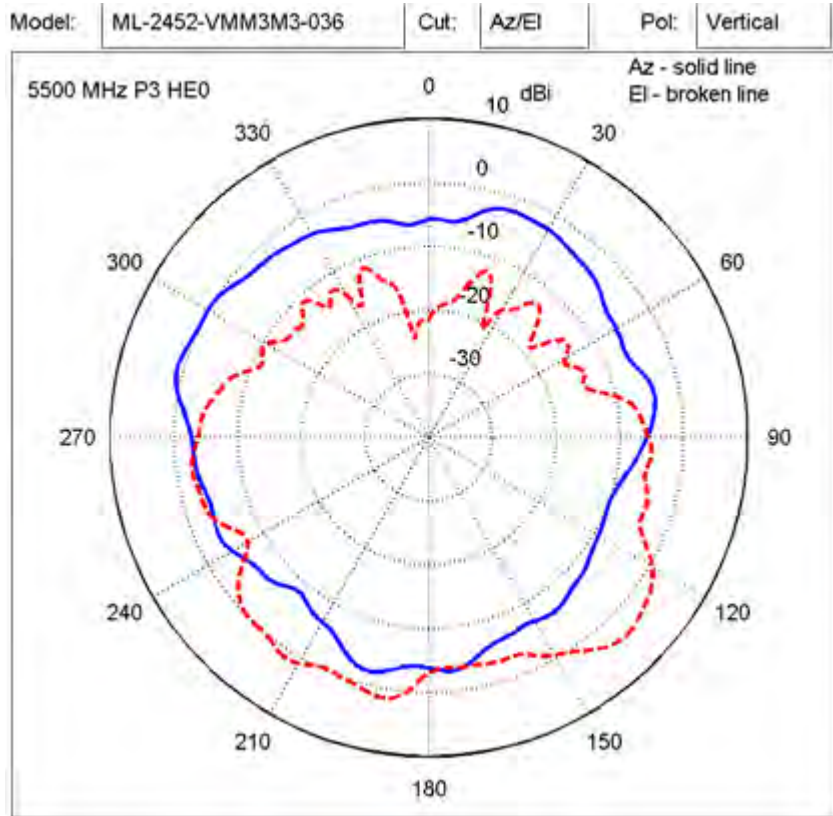
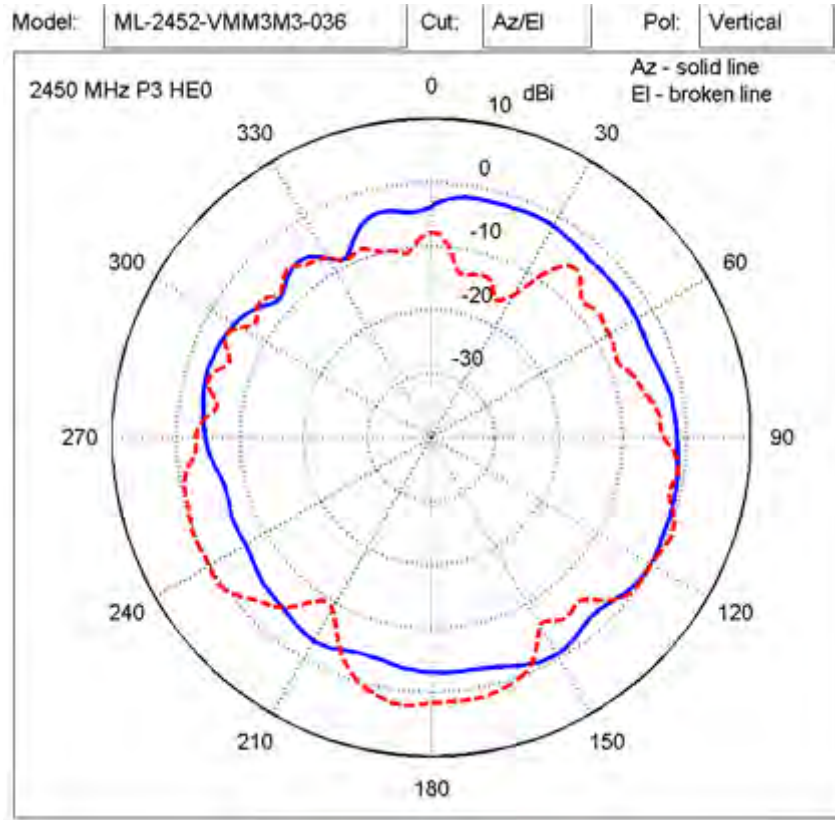

**5.1.18 AP6562 Internal 802.11ABGN, Multi-Element x 2**

<i>Type</i>	AP6562 Internal- Multi-element x 2 Single-band element - 2.4 GHz Dual-band element - 2.4/ 5GHz
<i>Frequency</i>	2412-2485, 5150-5850 MHz
<i>Max Gain (dBi)</i>	7.0/7.0
<i>Polarization</i>	Linear, Linear
<i>Azimuth</i>	3 dB Beamwidth: 120 degrees (5 GHz), 90 degrees (2.4 GHz)
<i>Elevation</i>	3 dB Beamwidth: 90 degrees (5 GHz), 90 degrees (2.4 GHz)
<i>Cable Length (centimeters)</i>	N/A
<i>Cable Type</i>	1.37 mm coax
<i>Connector Type</i>	U.FI x 4
<i>Antenna Plenum Rated</i>	N/A
<i>Cable Plenum Rated</i>	Yes
<i>Outdoor Rated</i>	Yes

Weight	< 4 oz.
Storage Temp Range (C)	-30 / +75
Operation Temp Range (C)	-20 / +65

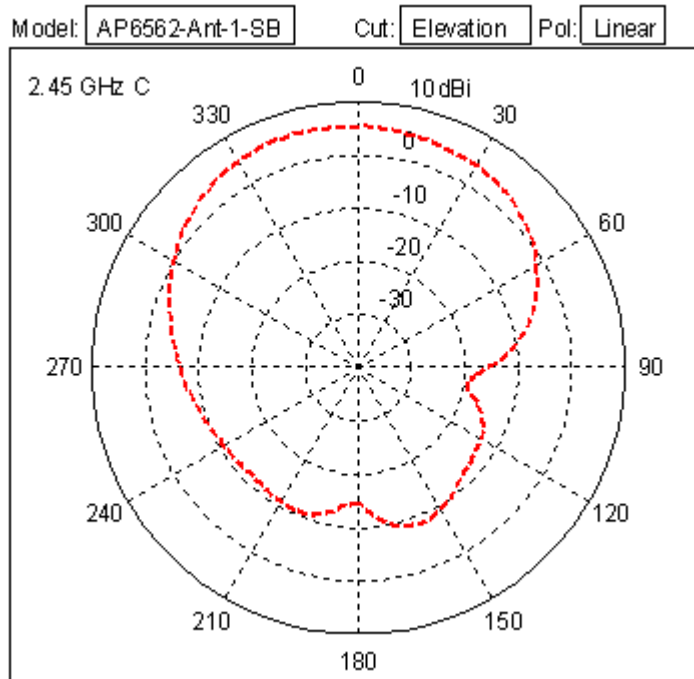
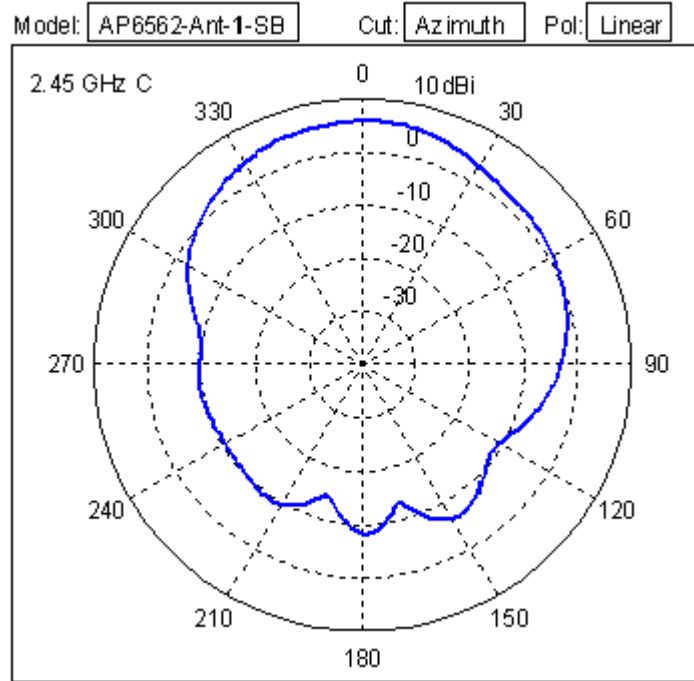



Model: AP6562-Ant-1-DB      Cut: Azimuth      Pol: Linear

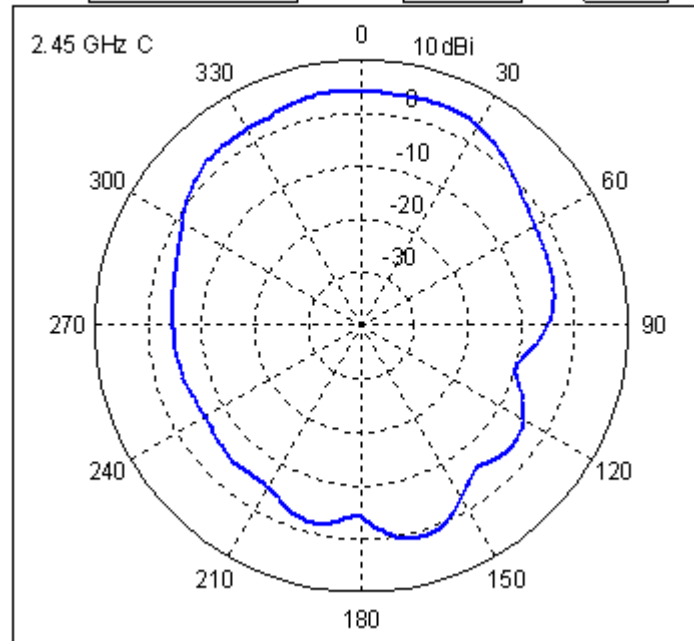

Model: AP6562-Ant-1-DB      Cut: Elevation      Pol: Linear

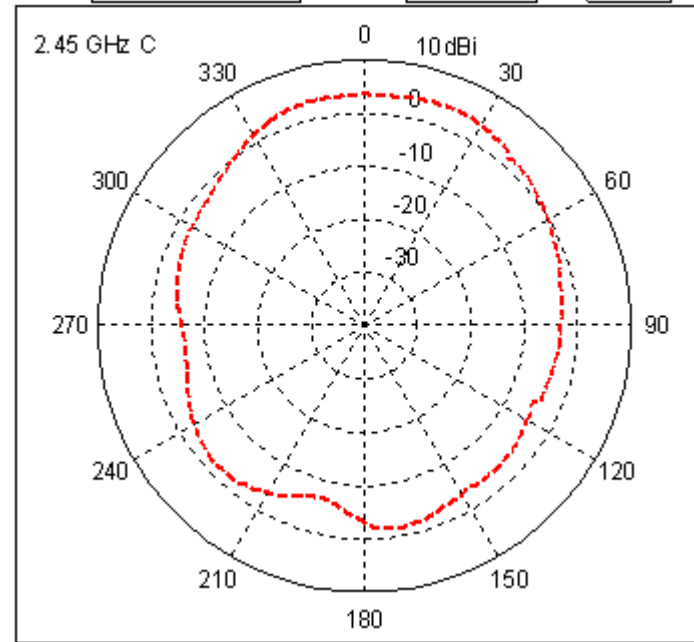

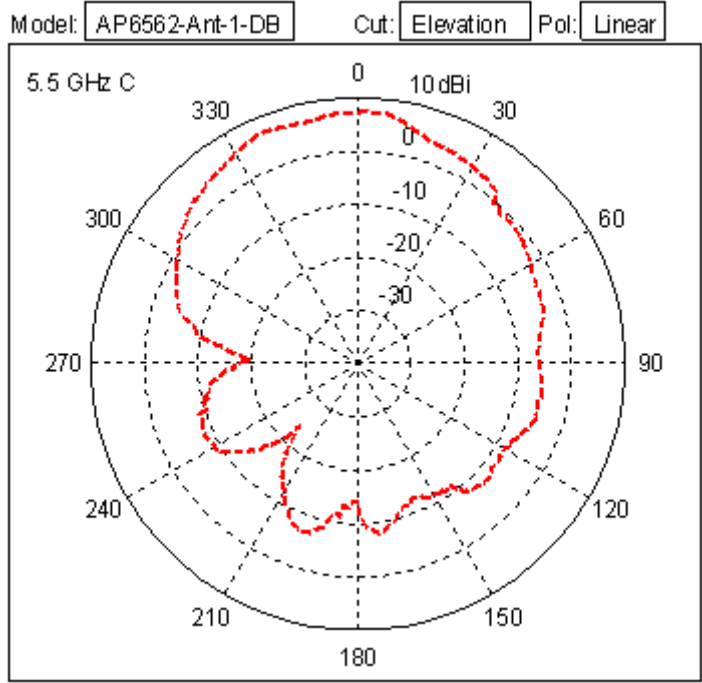
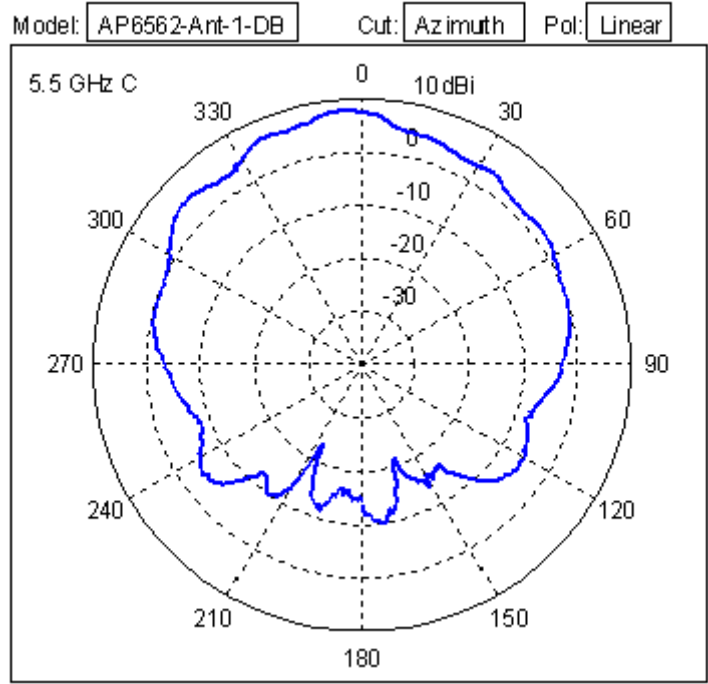

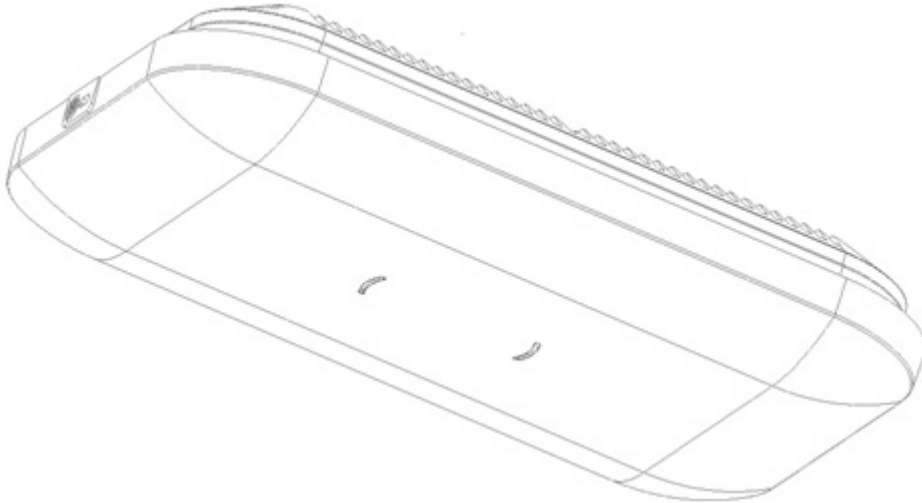
**5.1.19 AP8222 Internal 802.11ABGN, 6 x PIFA, -1.8 dBi, LP, U.FI**

<i>Type</i>	AP8222 Internal - Antennas 1, 2, 3 (3-Element PIFA Array, 5 GHz only)
<i>Frequency</i>	4900-5900 MHz
<i>Max Gain (dBi)</i>	5.3/-1.8
<i>Polarization</i>	Linear, Vertical
<i>Azimuth</i>	3 dB Beamwidth: 360 degrees (5 GHz)
<i>Elevation</i>	3 dB Beamwidth: 180 degrees (5 GHz)
<i>Cable Length (centimeters)</i>	18
<i>Cable Type</i>	N/A
<i>Connector Type</i>	U.FI x 3
<i>Antenna Plenum Rated</i>	N/A
<i>Cable Plenum Rated</i>	No
<i>Outdoor Rated</i>	No
<i>Weight</i>	TBD
<i>Storage Temp Range (C)</i>	-40/ +70
<i>Operation Temp Range (C)</i>	-20/ +70

<i>Type</i>	AP8222 Internal - Antennas 4, 5, 6 (3-Element PIFA Array, 2.4 & 5 GHz)
<i>Frequency</i>	2400-2500/4900-5900 MHz
<i>Max Gain (dBi)</i>	4.3/-1.8 (2 GHz), 4.7/-1.8 (5 GHz)
<i>Polarization</i>	Linear, Vertical
<i>Azimuth</i>	3 dB Beamwidth: 360 degrees (2.4 GHz) 3 dB Beamwidth: 360 degrees (5 GHz)
<i>Elevation</i>	3 dB Beamwidth: 160 degrees (2.4 GHz) 3 dB Beamwidth: 160 degrees (5 GHz)
<i>Cable Length (centimeters)</i>	18
<i>Cable Type</i>	N/A
<i>Connector Type</i>	U.FI x 3
<i>Antenna Plenum Rated</i>	N/A
<i>Cable Plenum Rated</i>	No
<i>Outdoor Rated</i>	No
<i>Weight</i>	TBD
<i>Storage Temp Range (C)</i>	-40/ +70
<i>Operation Temp Range (C)</i>	-20/ +70

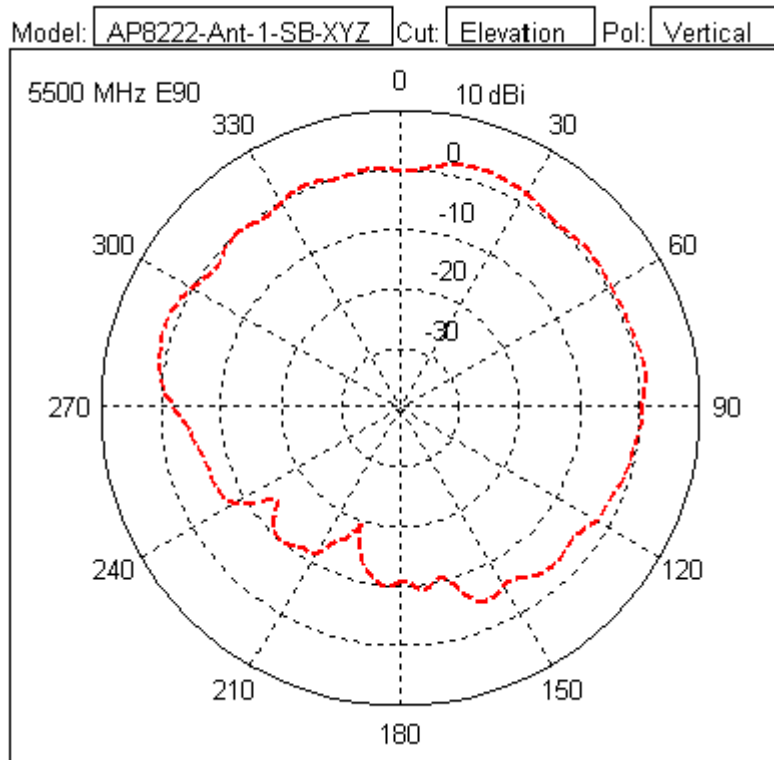
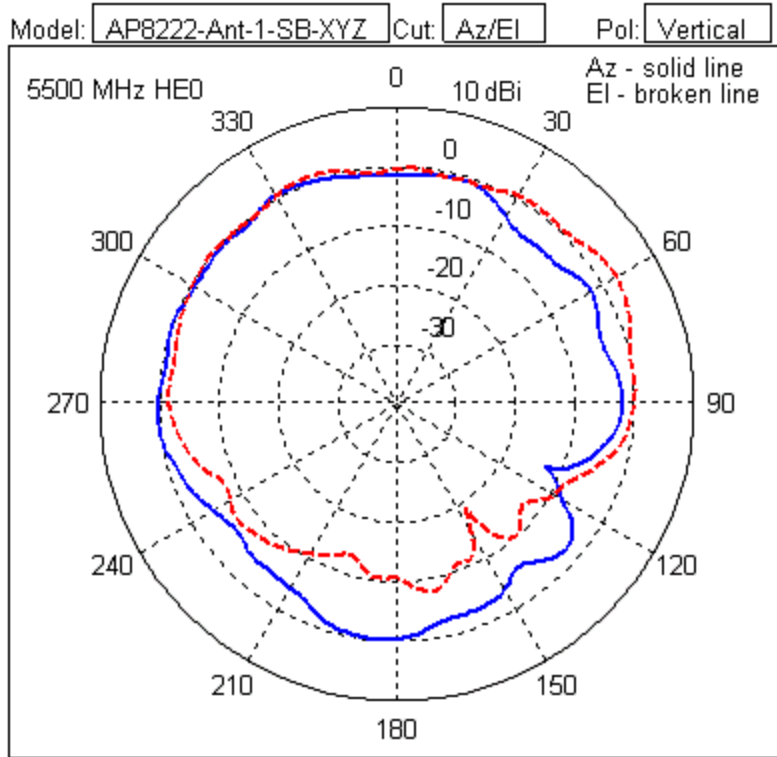

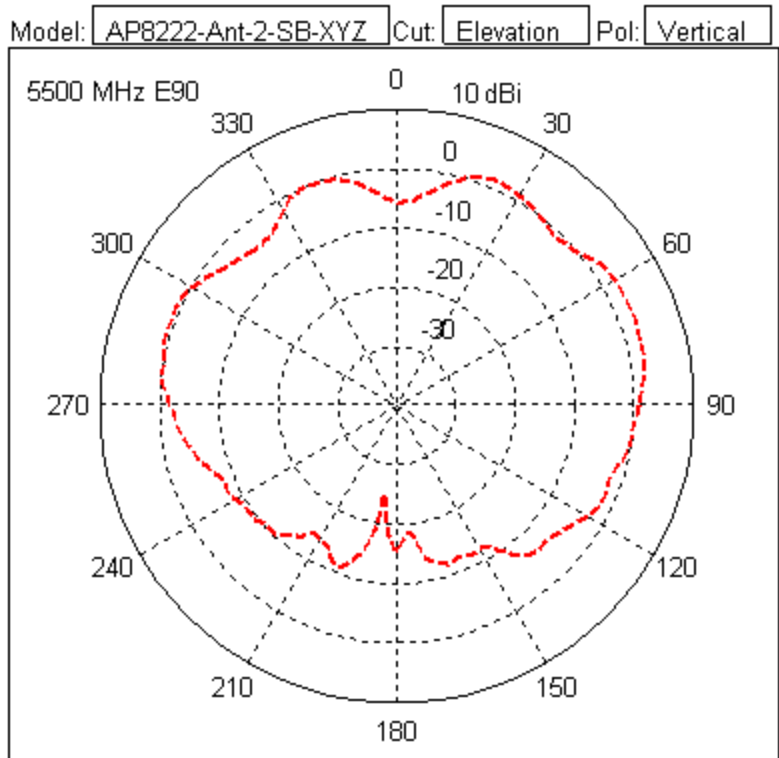
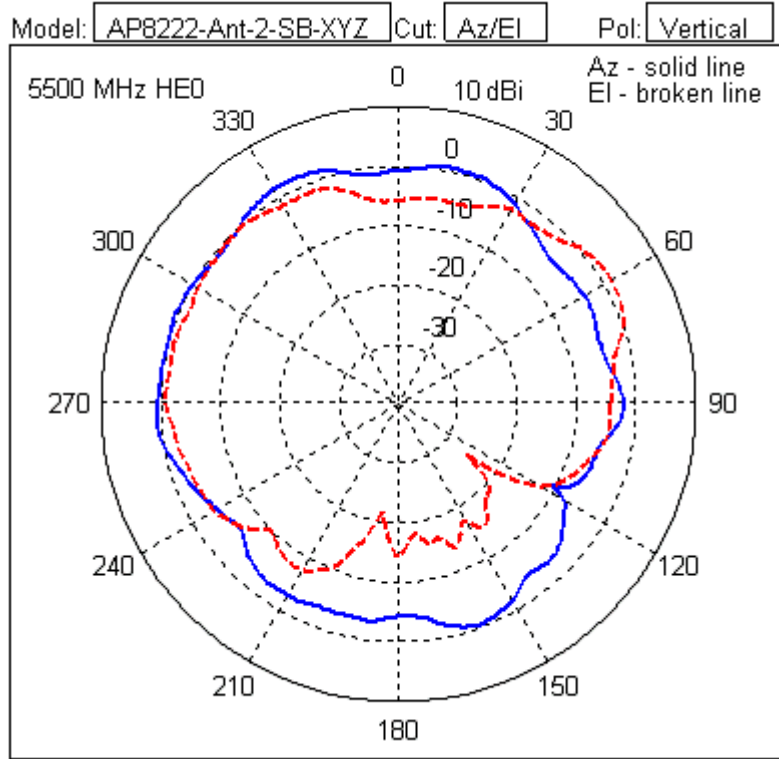

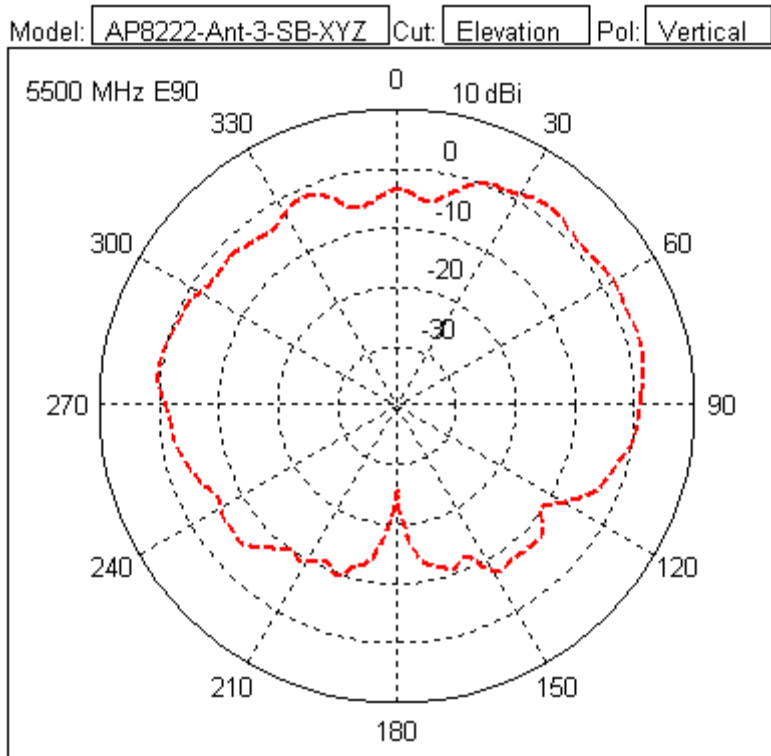
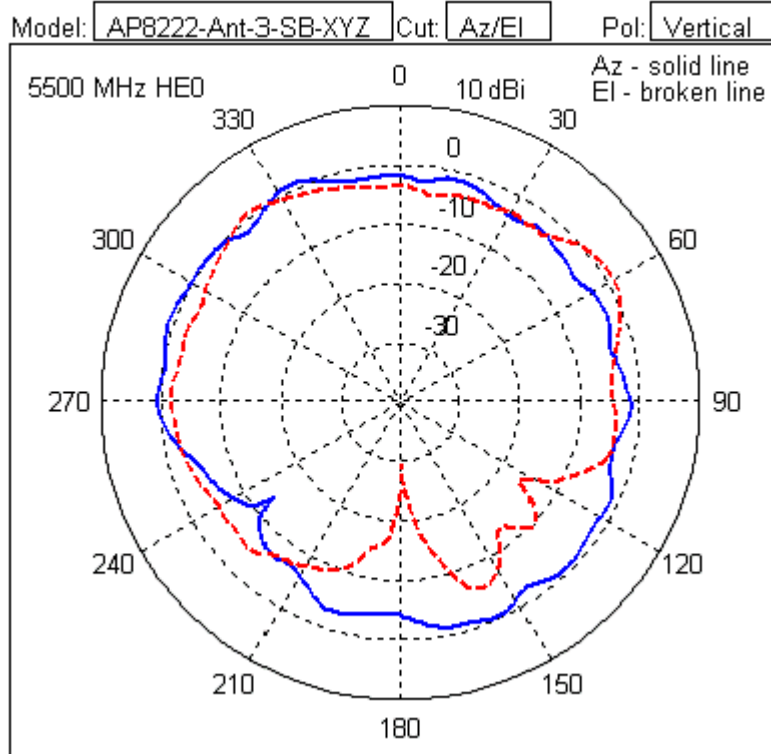

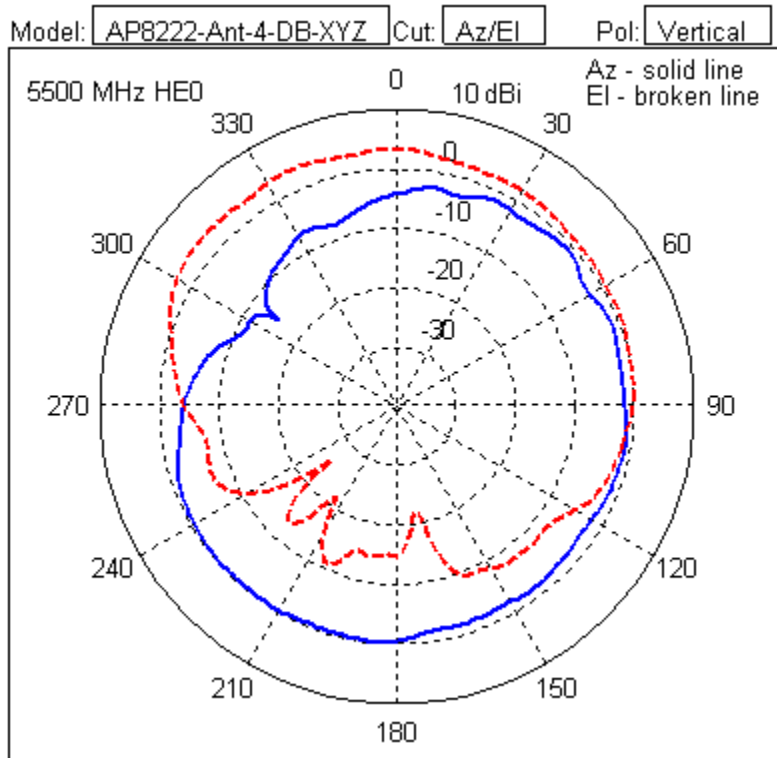
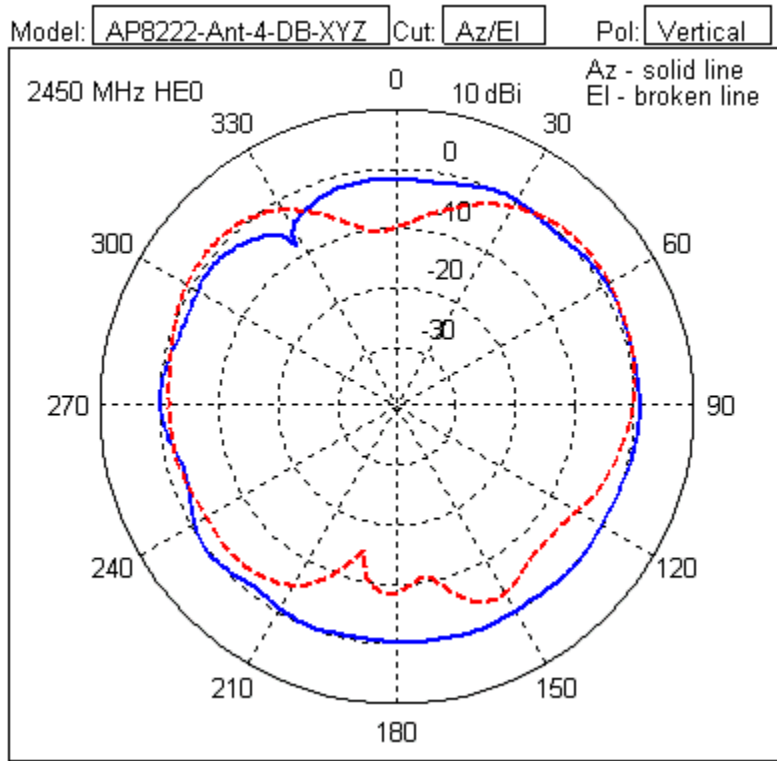



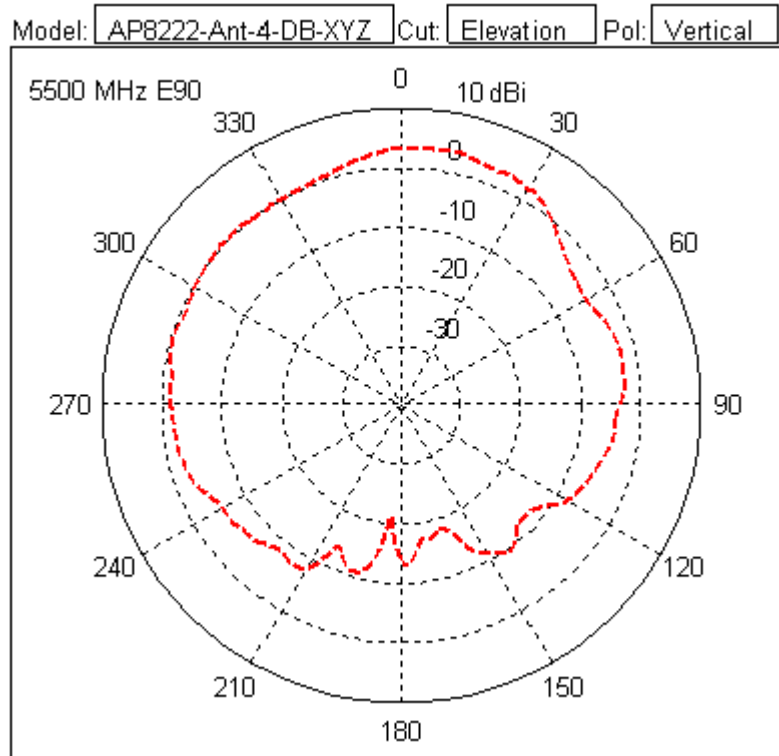
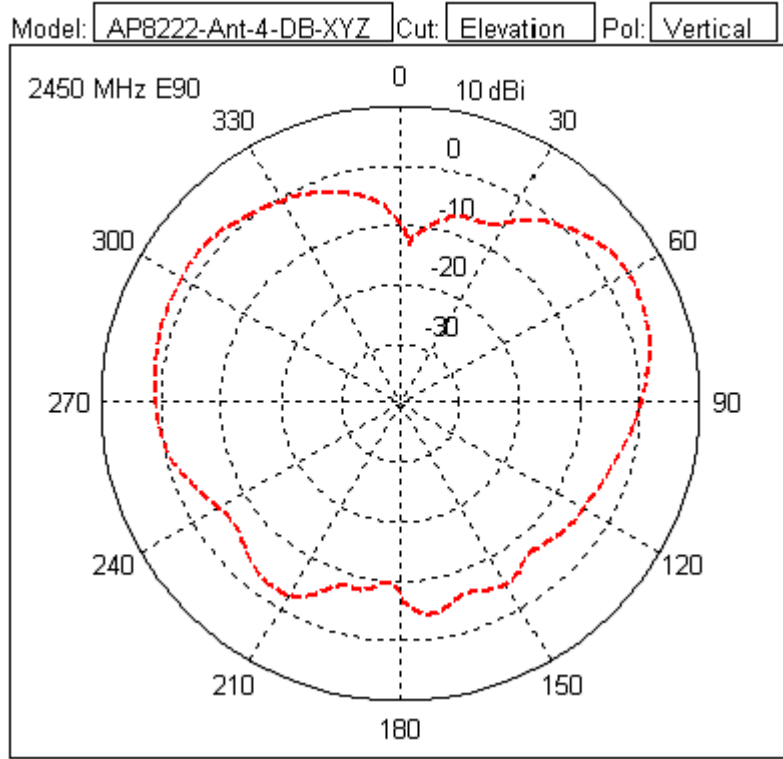

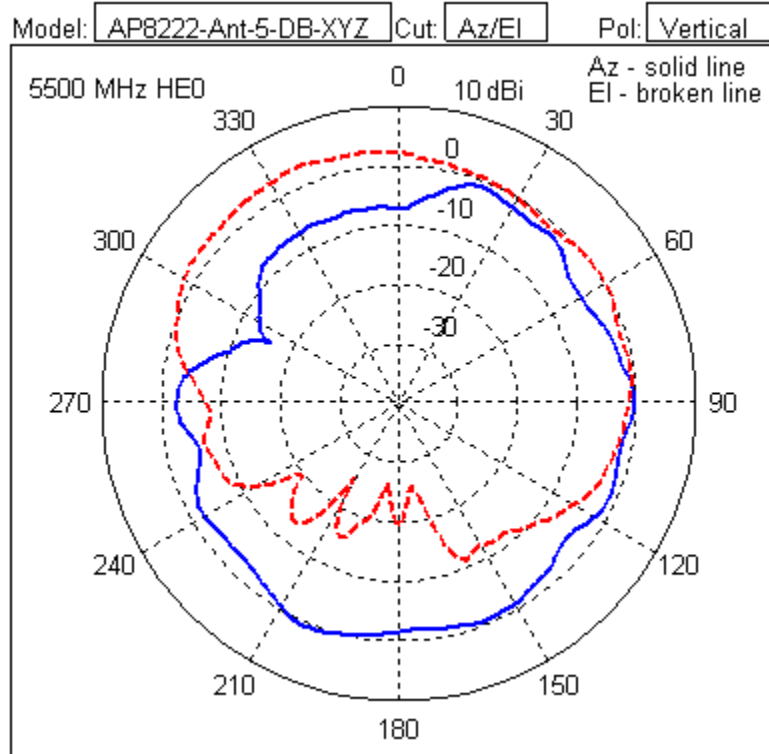
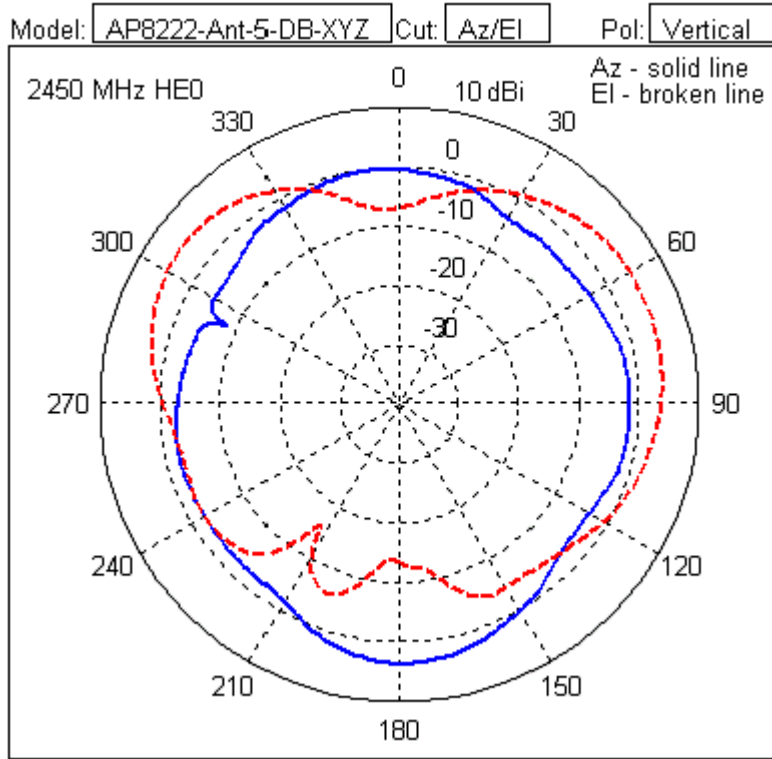

Model: AP8222-Ant-5-DB-XYZ Cut: Elevation Pol: Vertical

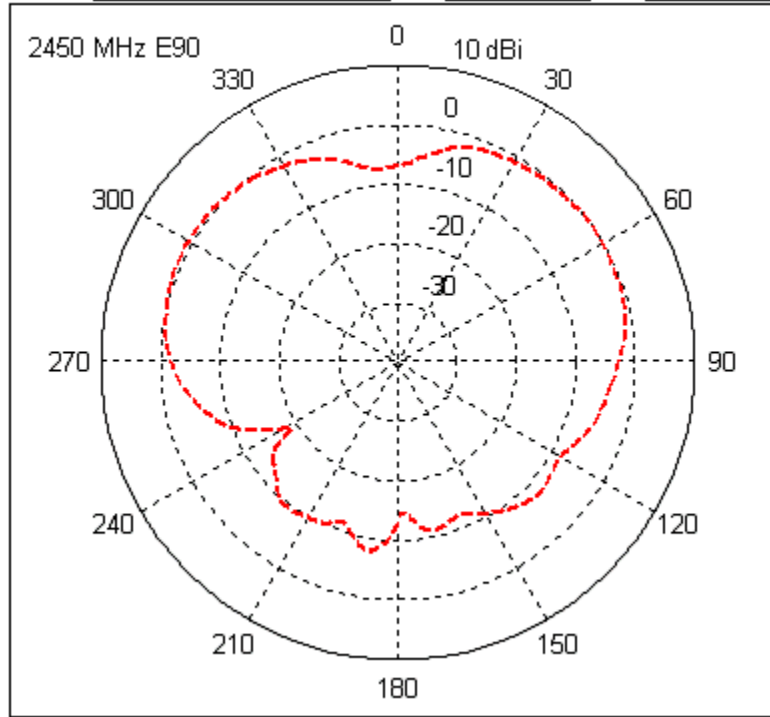

Model: AP8222-Ant-5-DB-XYZ Cut: Elevation Pol: Vertical

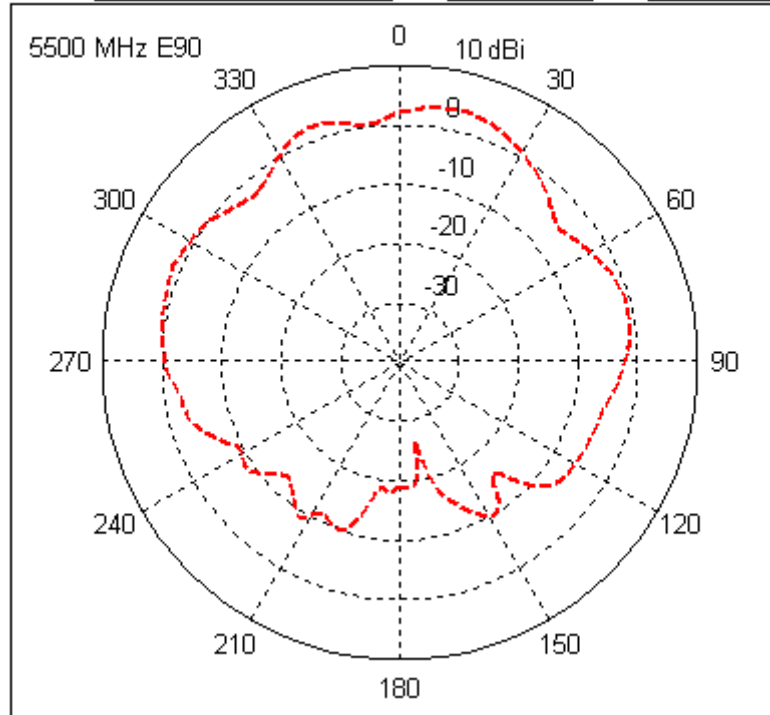

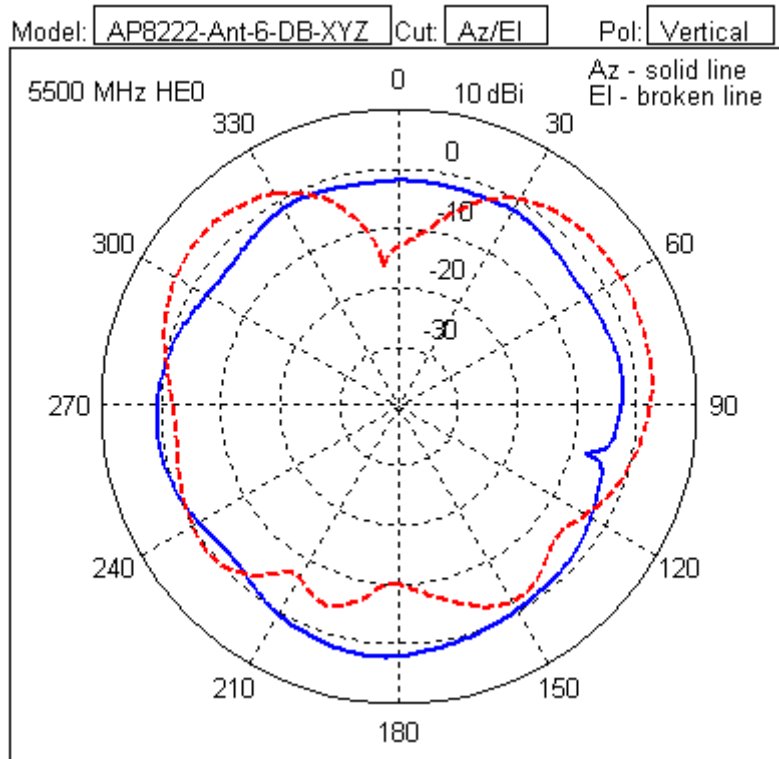
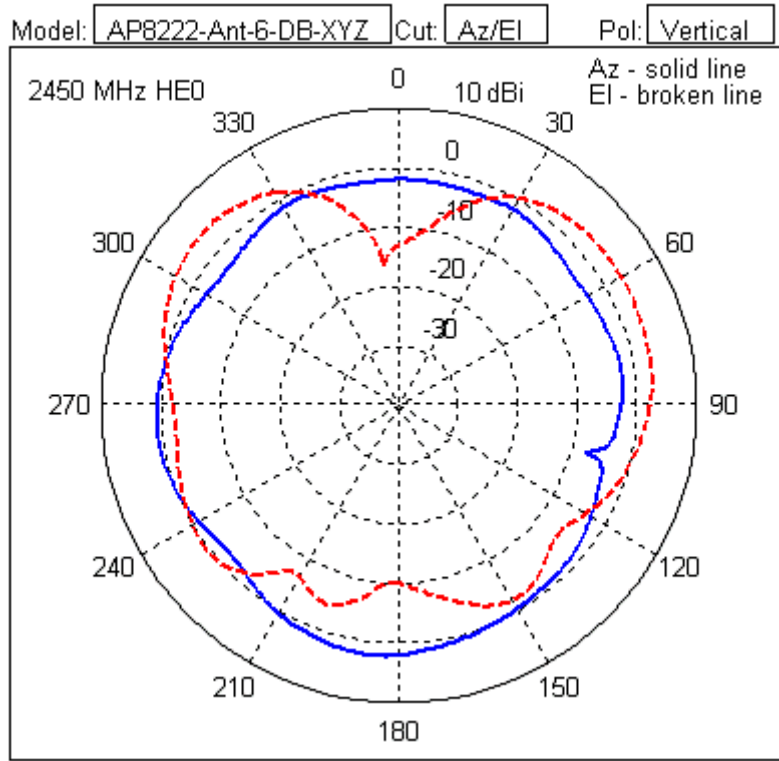

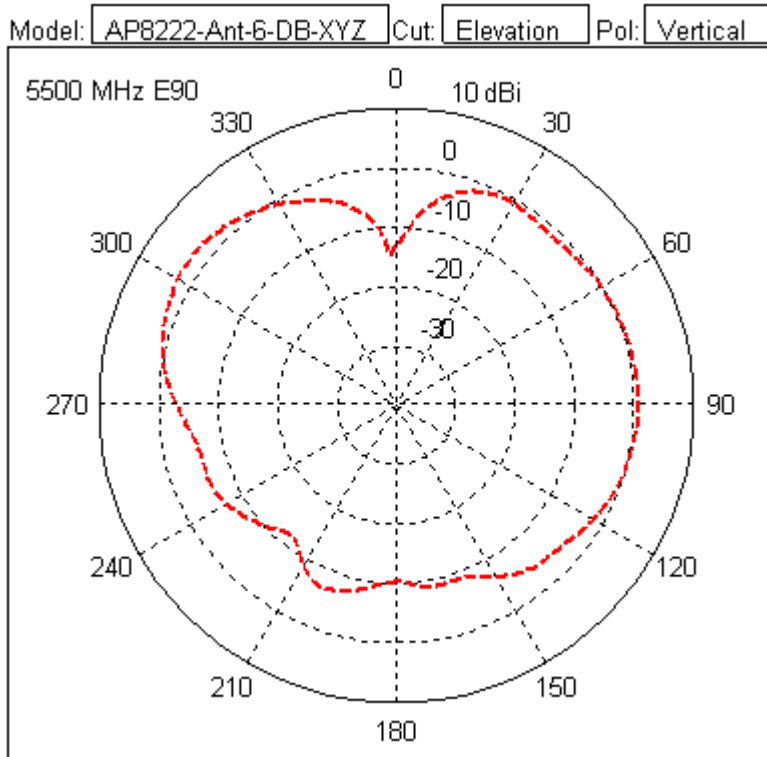
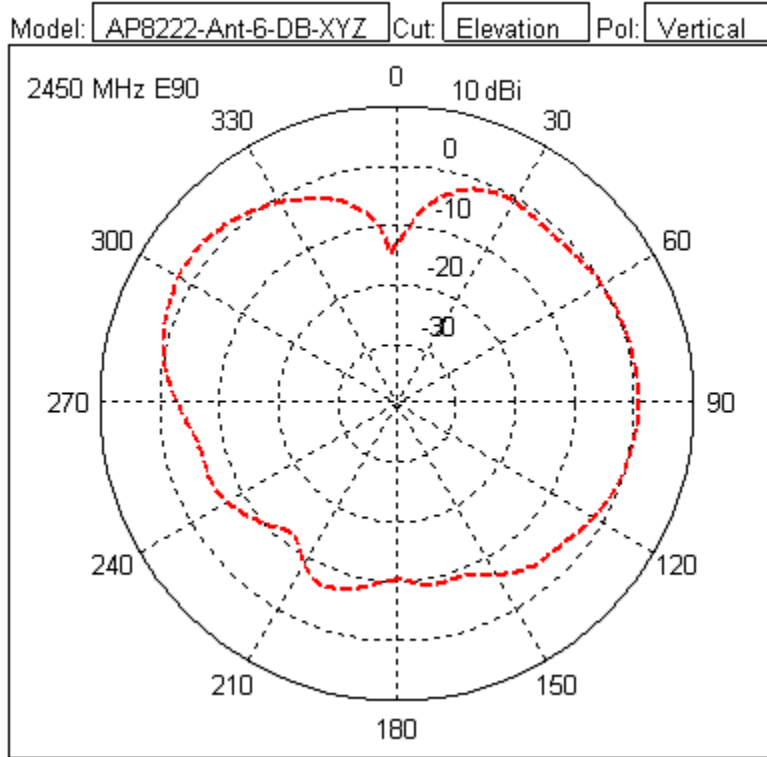

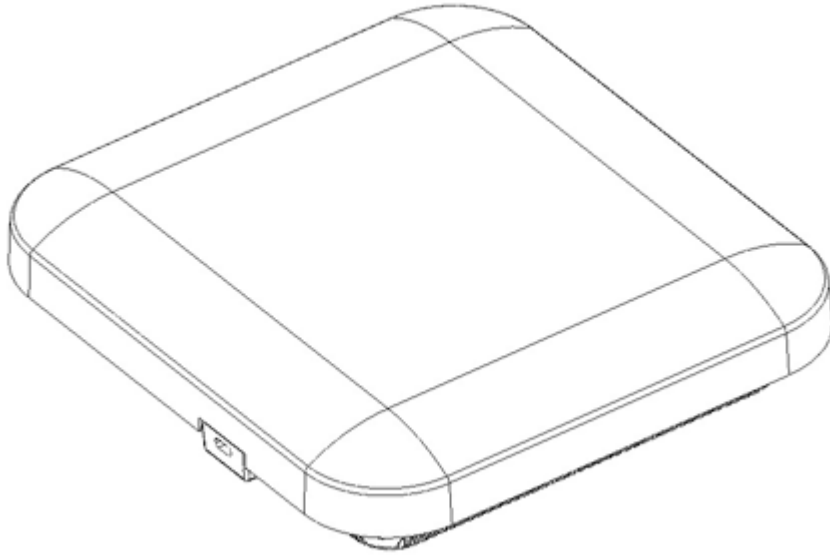
**5.1.20 AP-7522 and AP-7532 Dual-Band Monopole (2.4/5 Ghz)**

<i>Type</i>	AP-7522 and AP-7532 Dual-Band Monopole (2.4/5 Ghz)
<i>Frequency</i>	2400-2500, 5000-6000 MHz
<i>Max Gain (dBi)</i>	4.13/5.92
<i>Polarization</i>	Linear, Vertical
<i>Azimuth</i>	360 degrees
<i>Elevation</i>	160 degrees
<i>Cable Length (centimeters)</i>	N/A
<i>Cable Type</i>	N/A
<i>Connector Type</i>	U.FI
<i>Antenna Plenum Rated</i>	N/A
<i>Cable Plenum Rated</i>	N/A
<i>Outdoor Rated</i>	No
<i>Weight</i>	N/A
<i>Storage Temp Range (C)</i>	-40 / +70
<i>Operation Temp Range (C)</i>	-20 / +70

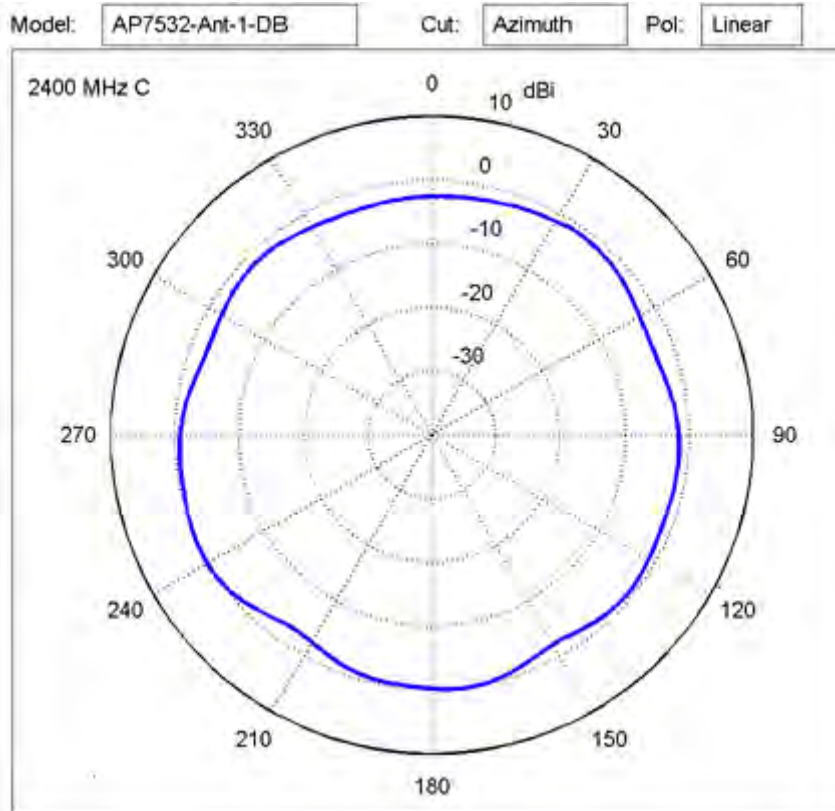
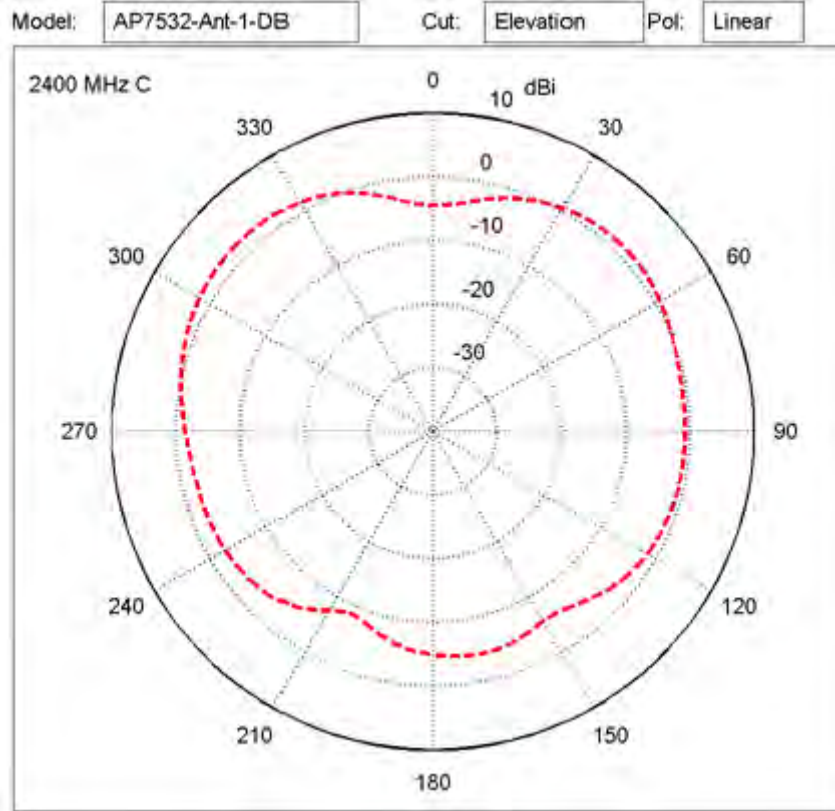

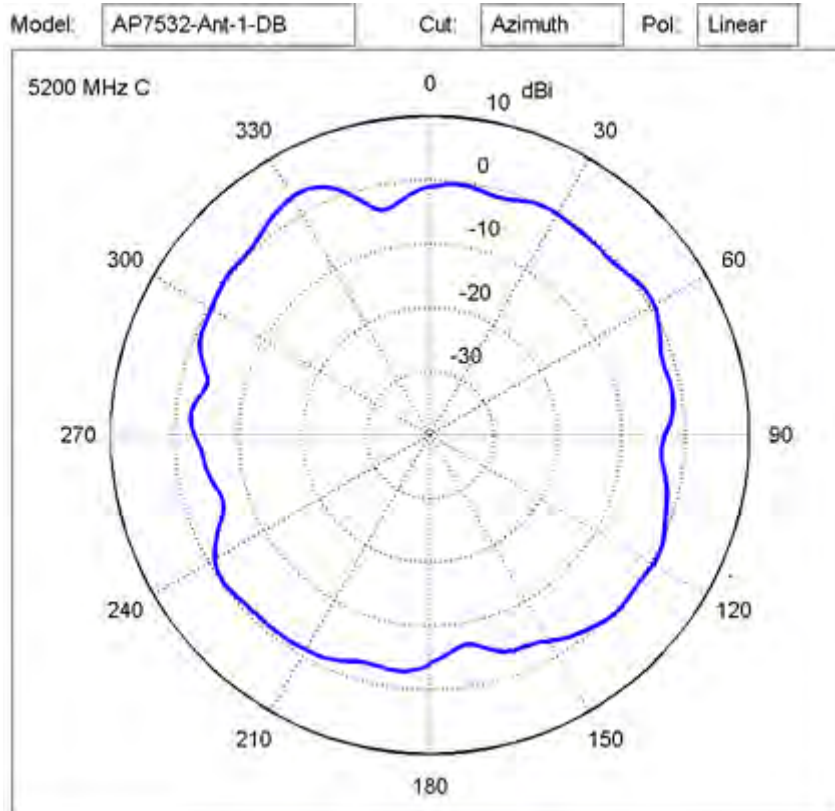
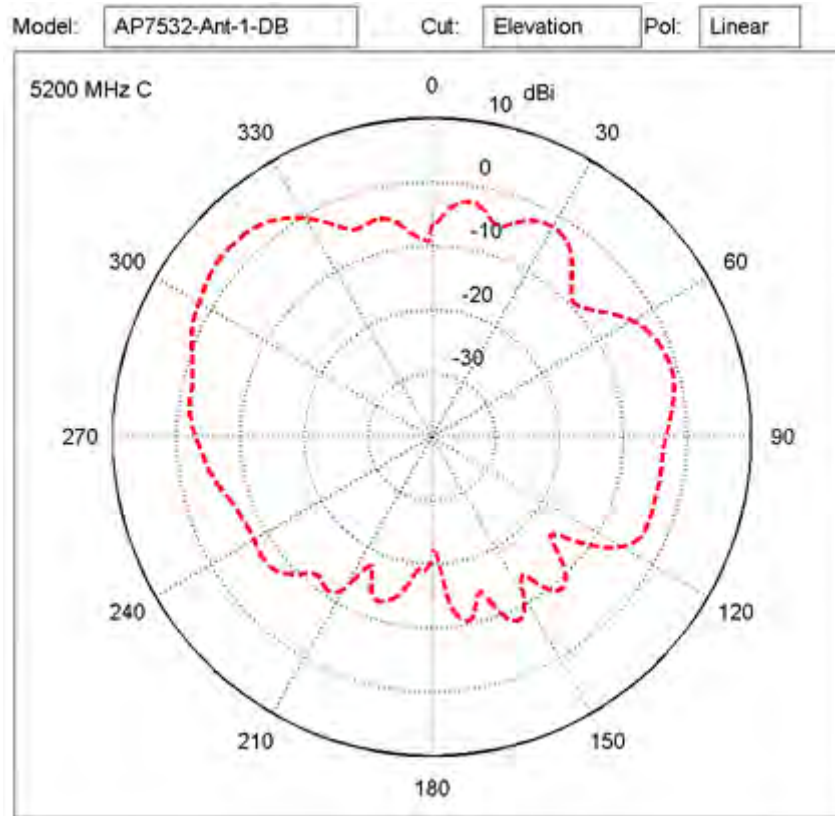



### 5.1.21 ML-2452-PNL3M3-1 11ABGN, 3-Port Directional Panel, 9.7/9.2 dBi, DP, Fixed N-Type Female

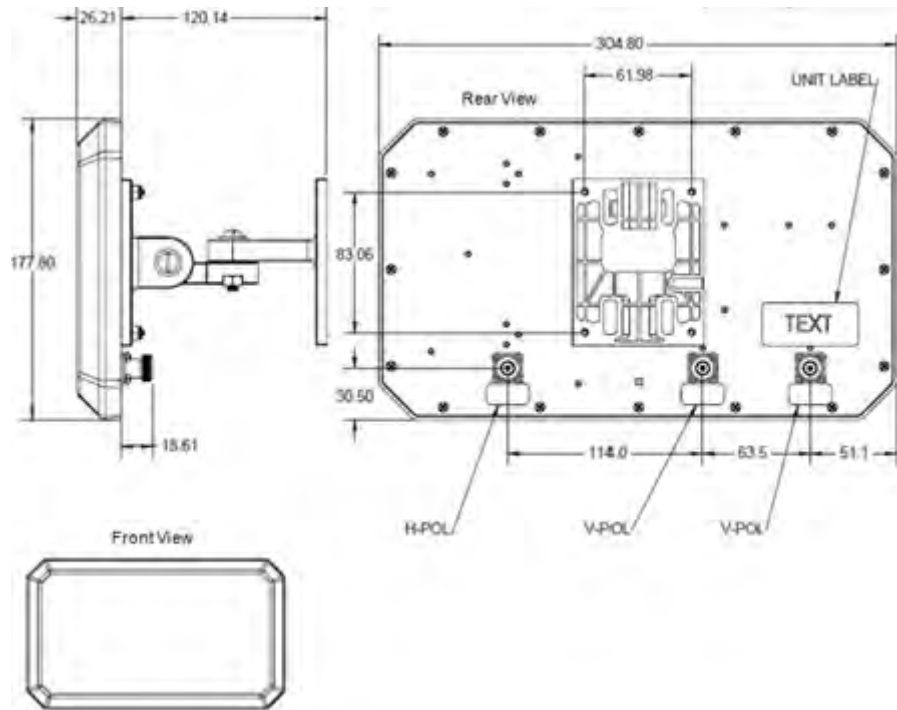

Type	3-Port Dual-Band Dir Panel(2 V-Pol and 1 H-Pol ports)
Frequency	2400-2500, 4900-5900
Max Gain (dBi)	9.5/9.2
Polarization	Linear, Vertical
Azimuth	90/120 degrees
Elevation	45/30 degrees
Cable Length (centimeters)	N/A
Cable Type	N/A
Connector Type	Fixed N-Type Female x 3
Antenna Plenum Rated	No
Cable Plenum Rated	N/A
Outdoor Rated	Yes
Weight	1.5 lbs
Storage Temp Range (C)	-40/+85
Operation Temp Range (C)	-30 / +70

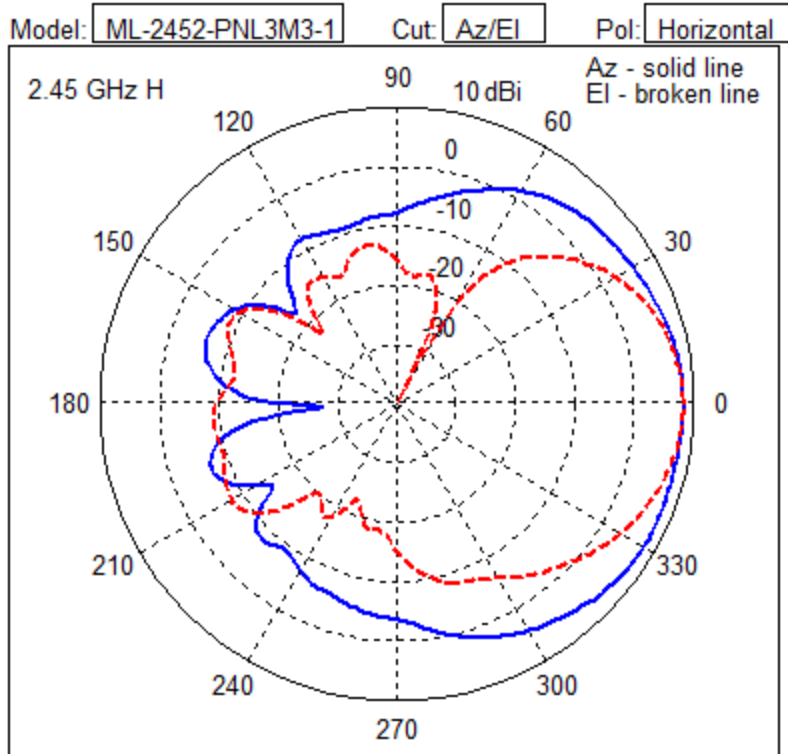
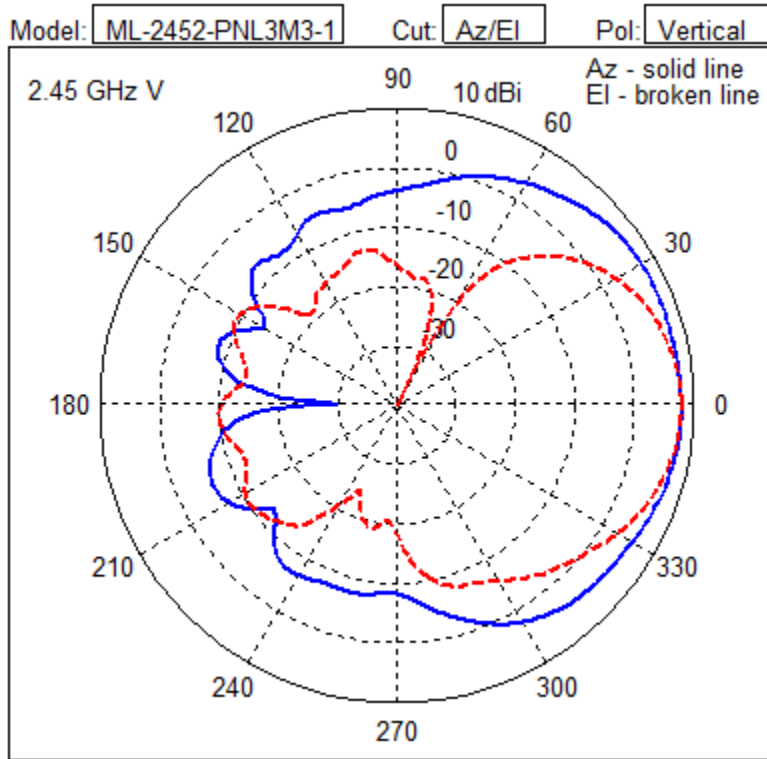

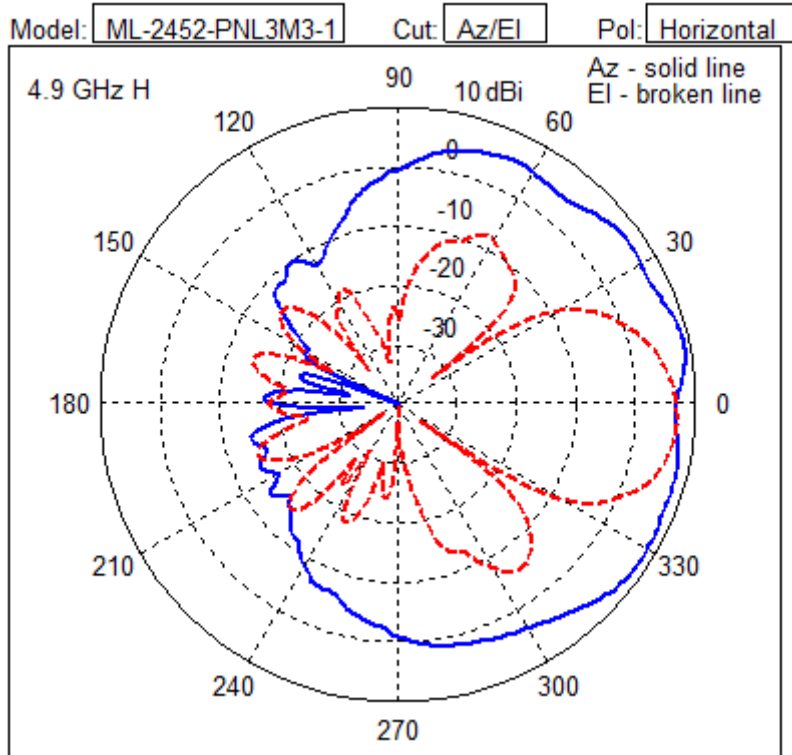
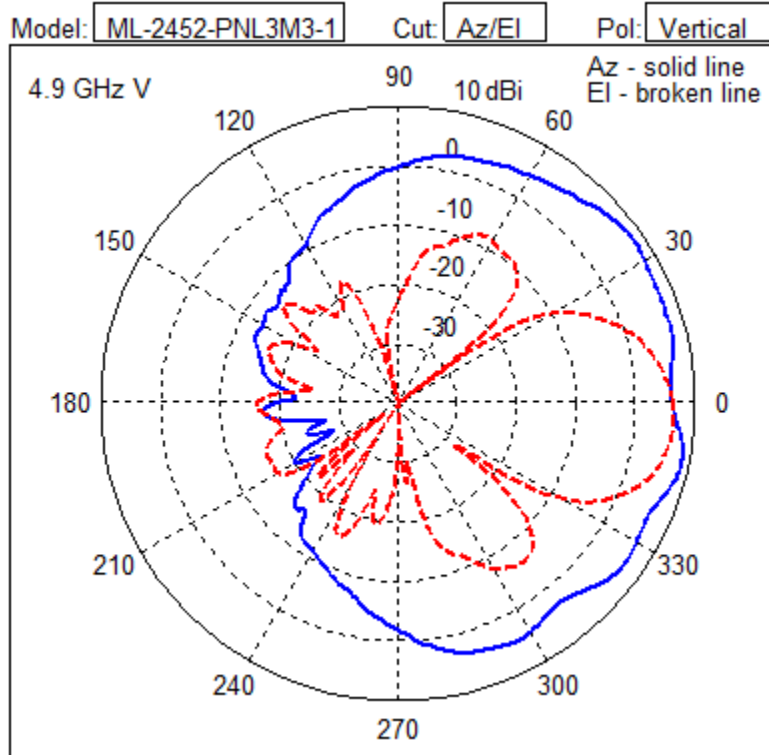

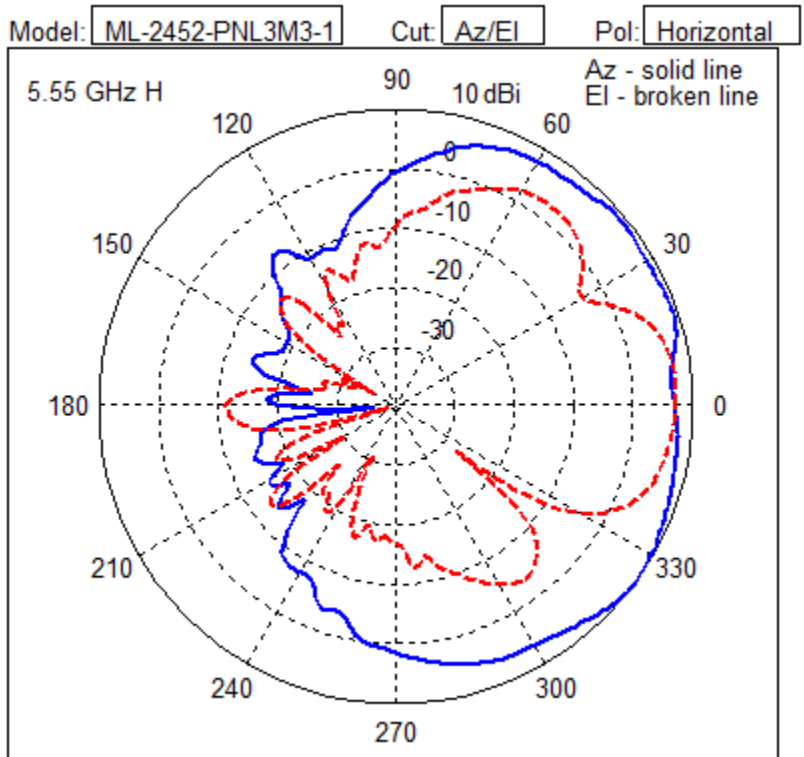
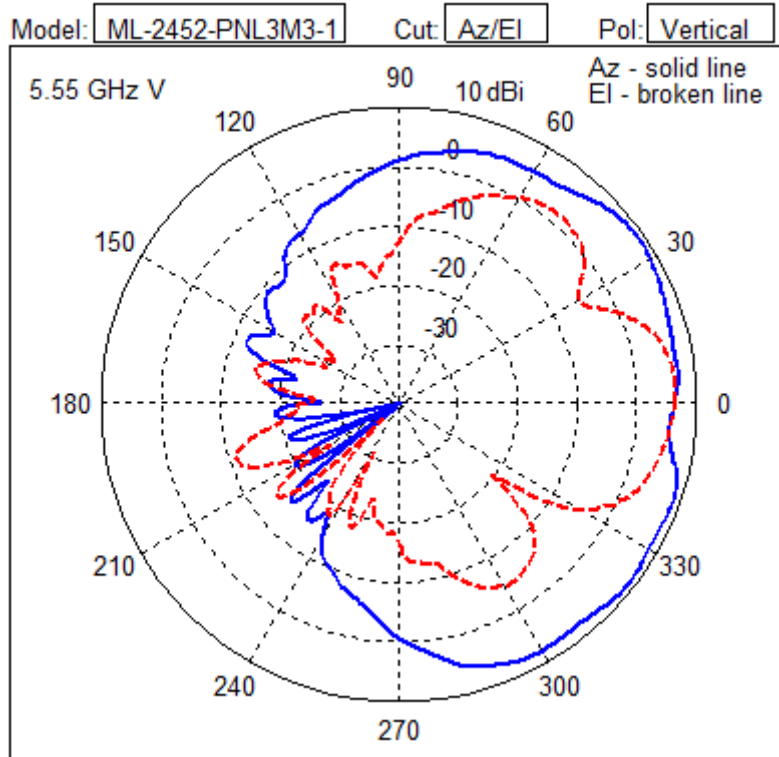

### 5.1.22 ML-2452-HPA6-01, 11ABGN, Dipole, N-Type Male

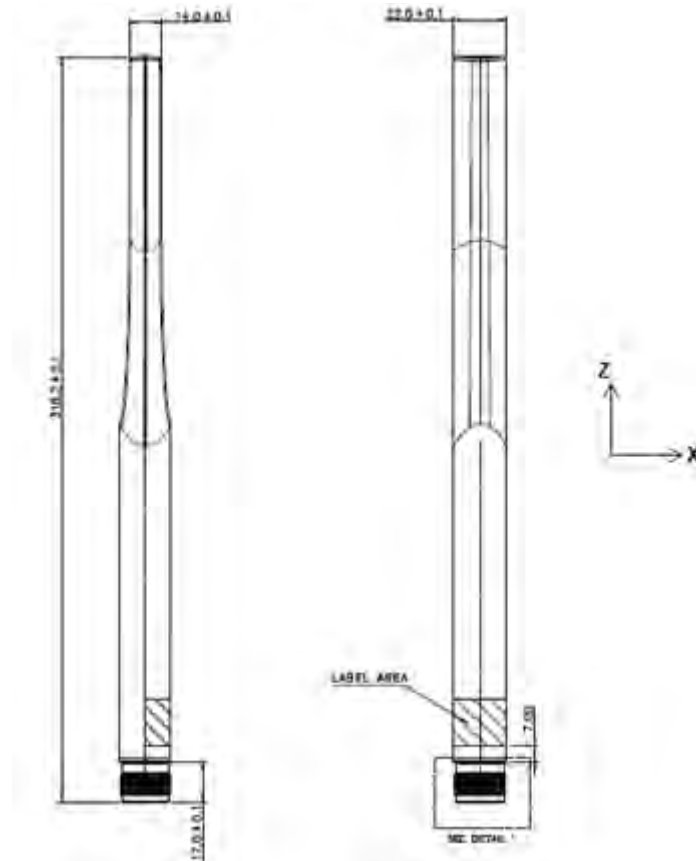

Type	Dipole
Frequency	2400-2500, 4950-4990, 5150-5875
Max Gain (dBi)	5.3/4.6/6.1
Elevation Gain (dBi)	4.1
Polarization	Linear, Vertical
Azimuth	360 degrees
Elevation	30 degrees
Cable Length (centimeters)	N/A
Cable Type	N/A
Connector Type	N-Type Male
Antenna Plenum Rated	N/A
Cable Plenum Rated	N/A
Outdoor Rated	Yes

Weight (lbs)	0.25
Storage Temp Range (C)	-40/+85
Operation Temp Range (C)	-40/+85

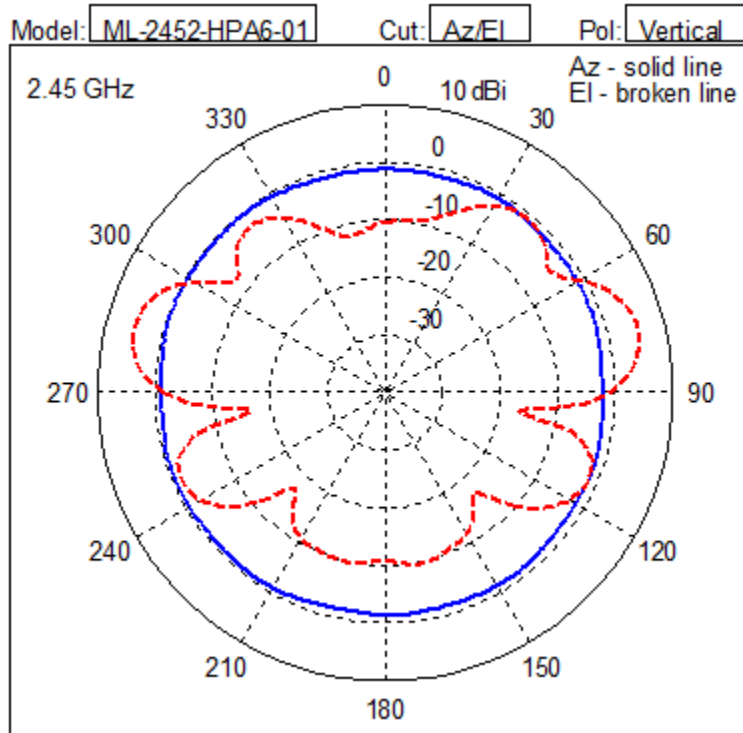

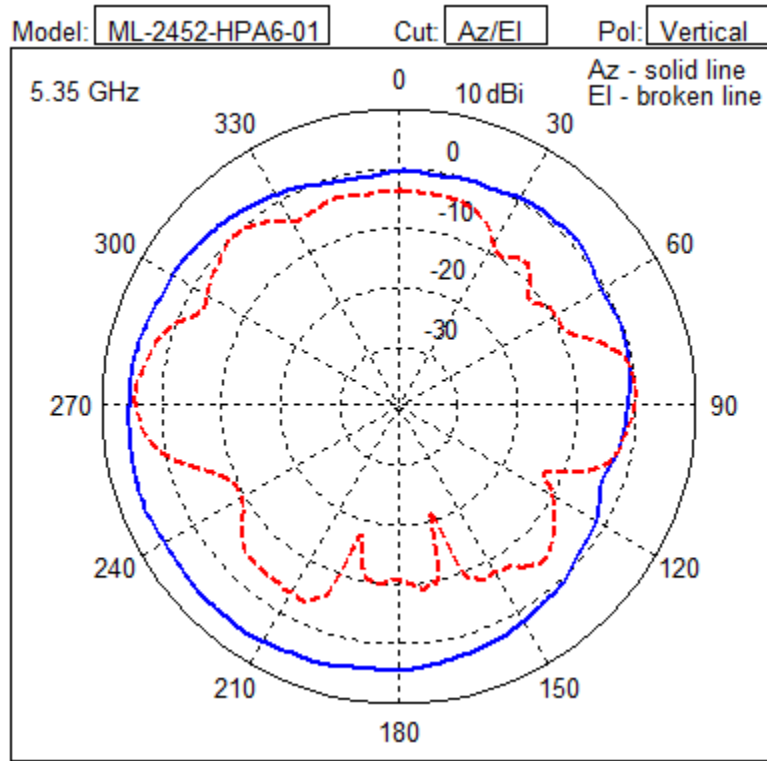

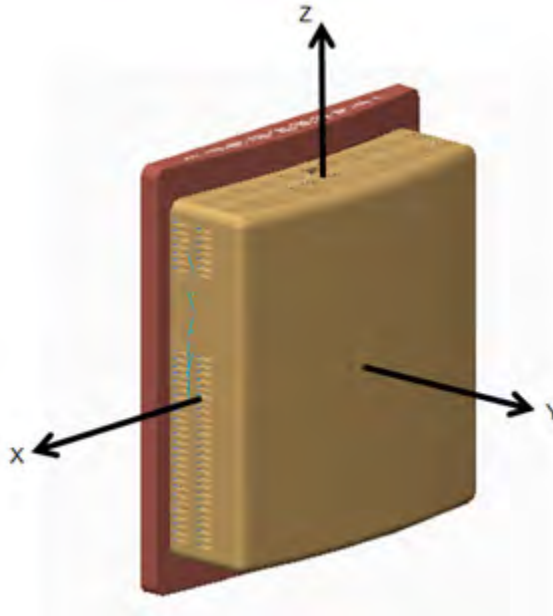
**5.1.23 AP7502 Internal 802.11ABGNac, Dipole Omni x4**

<i>Type</i>	AP7502 Internal- Dipole Omni x4 2.4 GHz Dipole x 2 5GHz Dipole x2
<i>Frequency</i>	2400-2500, 5150-5850 MHz
<i>Max Gain (dBi)</i>	5.8, 7.3 (2.4GHz/5GHz)
<i>Polarization</i>	Linear, Vertical
<i>Azimuth 3 dB Beamwidth:</i>	120°/90° (2.4GHz/5GHz)
<i>Elevation 3 dB Beamwidth:</i>	90°/90° (2.4GHz/5GHz)
<i>Cable Length (centimeters)</i>	N/A
<i>Cable Type</i>	1.37 mm coax
<i>Connector Type</i>	U.FI x 4
<i>Antenna Plenum Rated</i>	N/A
<i>Cable Plenum Rated</i>	N/A
<i>Outdoor Rated</i>	No
<i>Weight</i>	N/A
<i>Storage Temp Range (C)</i>	0°/40°
<i>Operation Temp Range (C)</i>	0°/40°



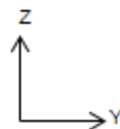
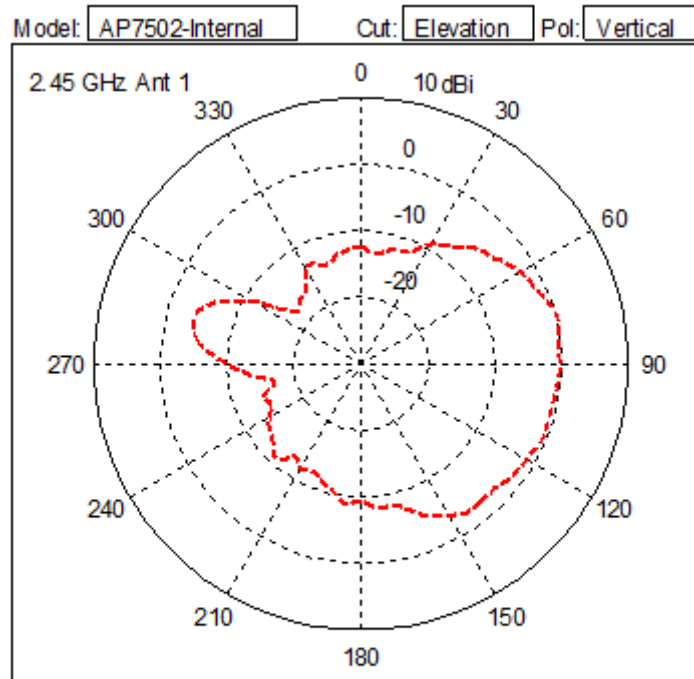
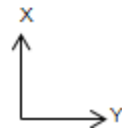
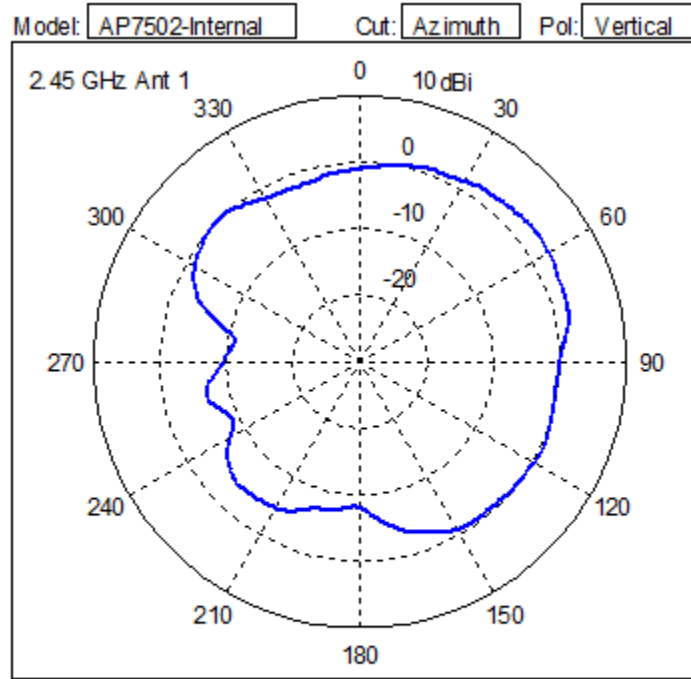

Model:  Cut:  Pol:

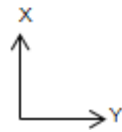
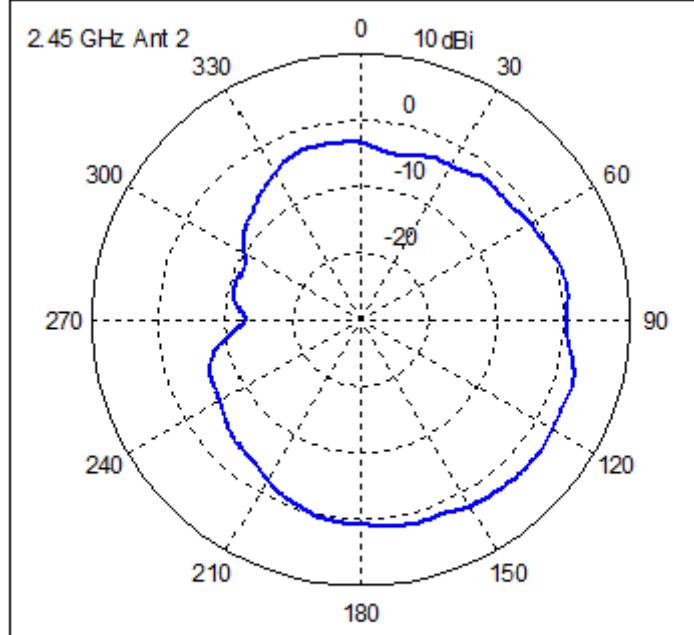

Model:  Cut:  Pol:

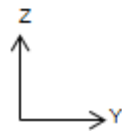
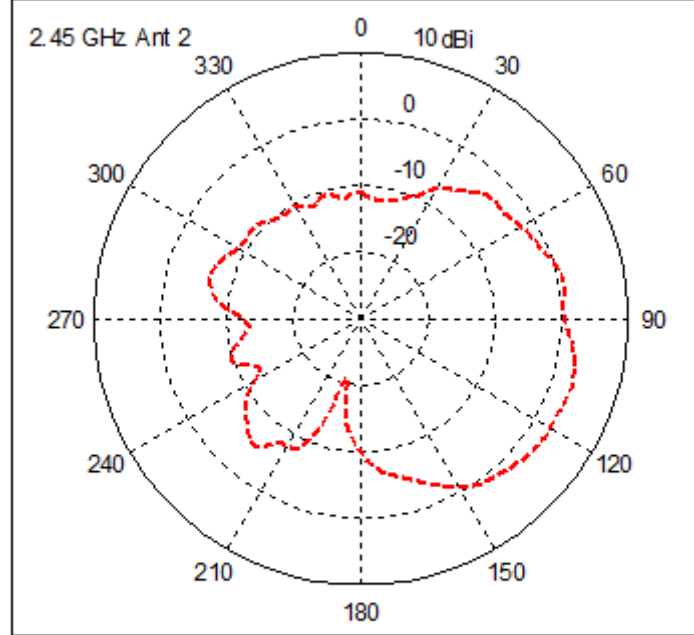

Model: AP7502-Internal    Cut: Azimuth    Pol: Vertical

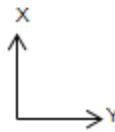
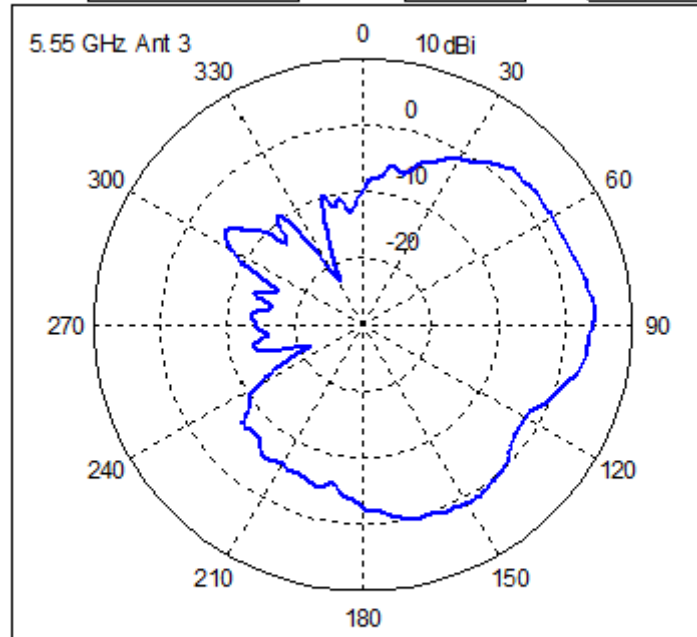

Model: AP7502-Internal    Cut: Elevation    Pol: Vertical

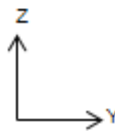
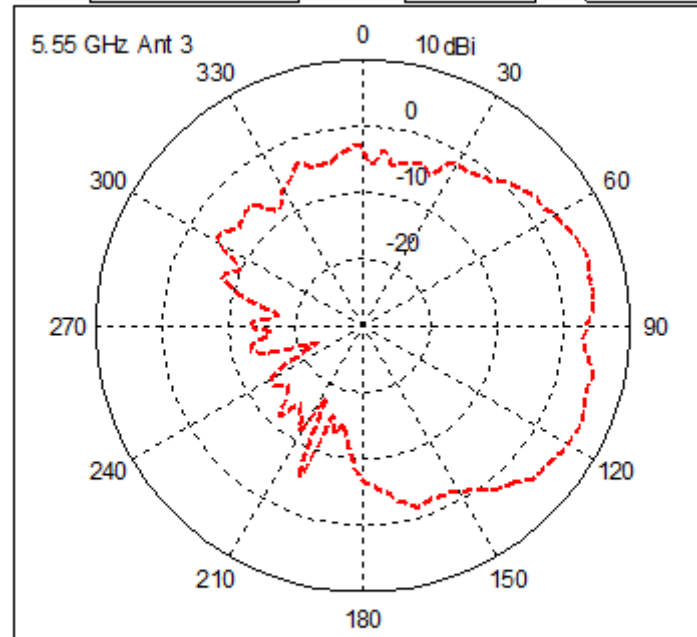

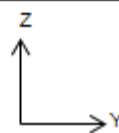
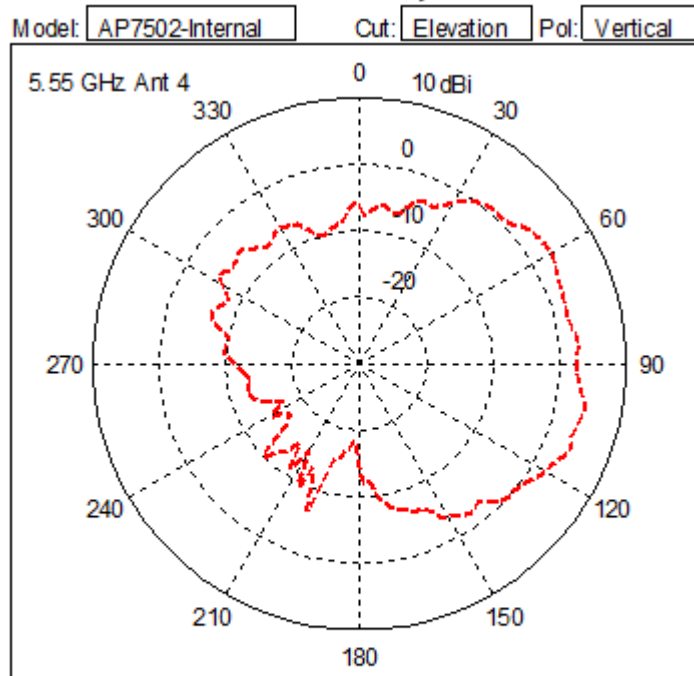
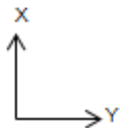
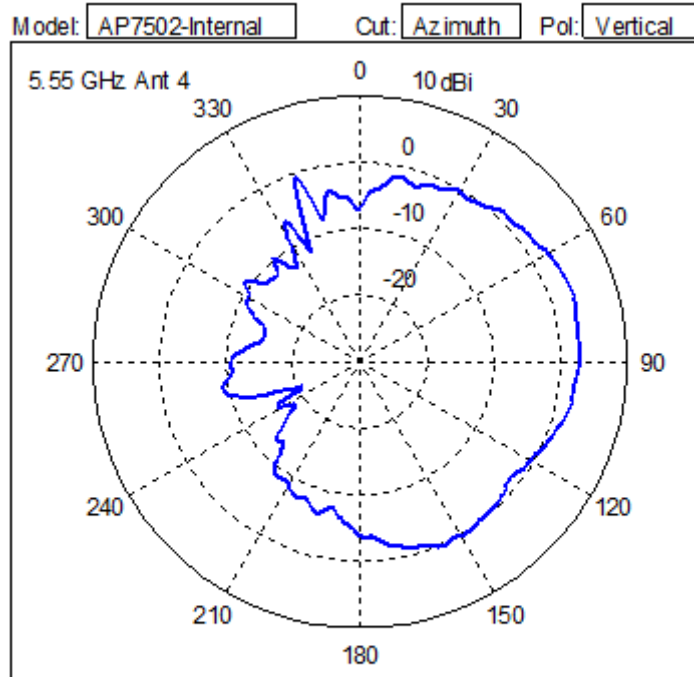

### 5.1.24 ML-2452-PNL6M3-N36, 11ABGN, 120° Sector, 3-Port, 6/6 dBi, LP, CBL 36, N-Type-M

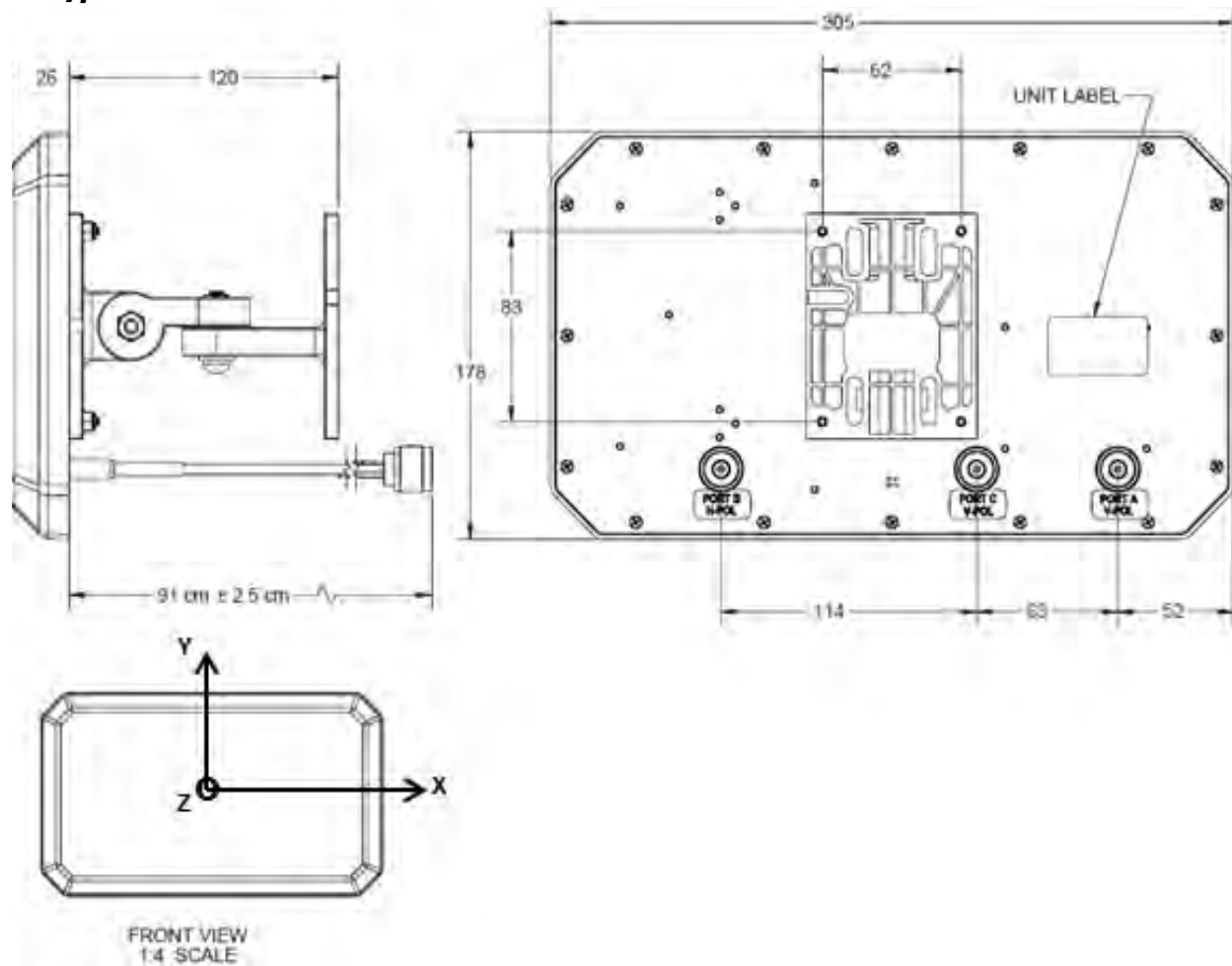

Type	Polarized Panel
Frequency	2400-2500, 4900-5900 MHz
Max Gain (dBi)	6.0 (2.4GHz/5GHz)
Polarization	Port A -Linear, Vertical Port B -Linear, Horizontal Port C -Linear, Vertical
Azimuth 3 dB Beamwidth:	110°/110° (2.4GHz/5GHz)
Elevation 3 dB Beamwidth:	75°/45° (2.4GHz/5GHz)
Cable Length (centimeters)	91
Cable Type	LMR195 equivalent
Connector Type	N-Type Male x 3
Antenna Plenum Rated	No

Cable Plenum Rated	N/A
Outdoor Rated	Yes
Weight (kgs)	0.69
Storage Temp Range (C)	-40°/85°
Operation Temp Range (C)	-30°/70°

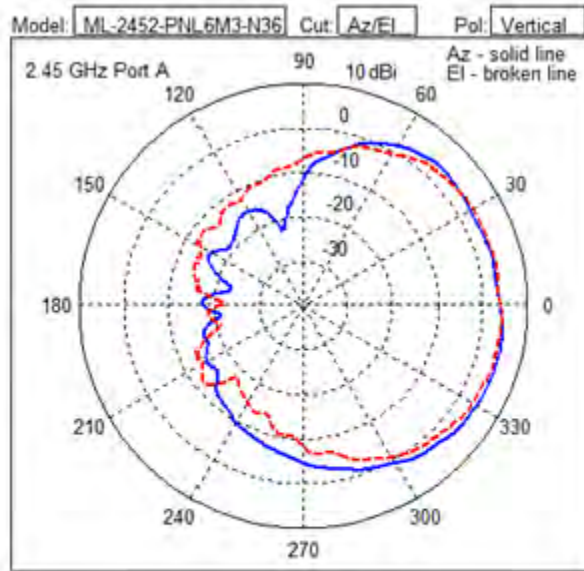

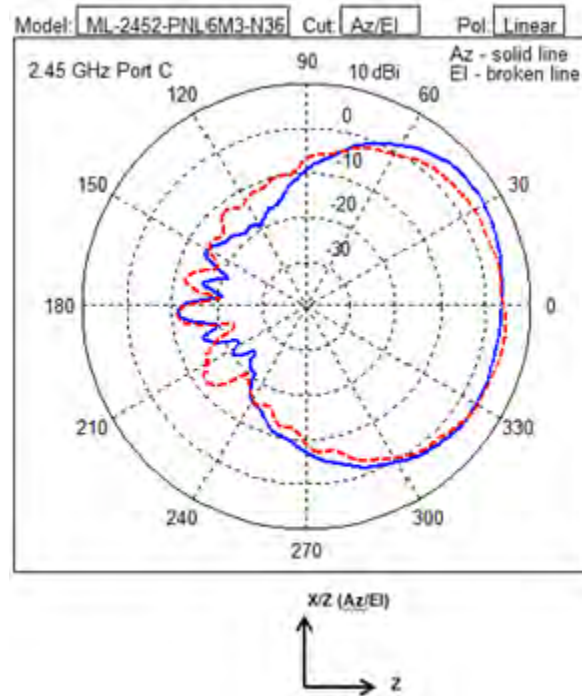
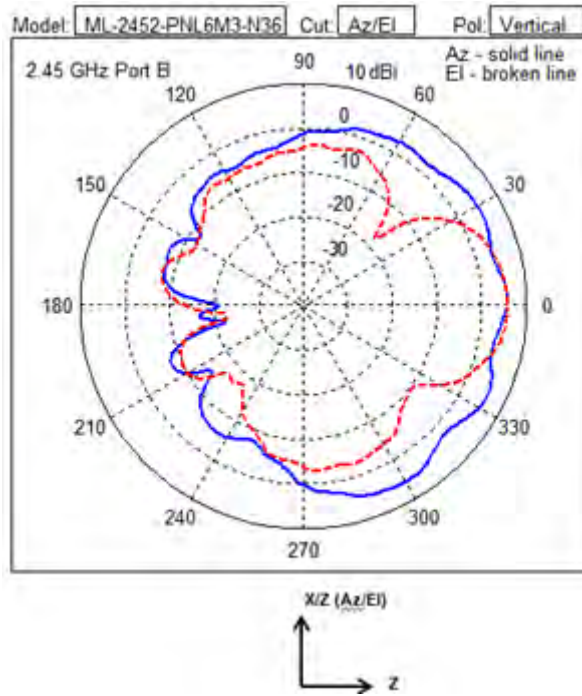

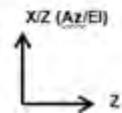
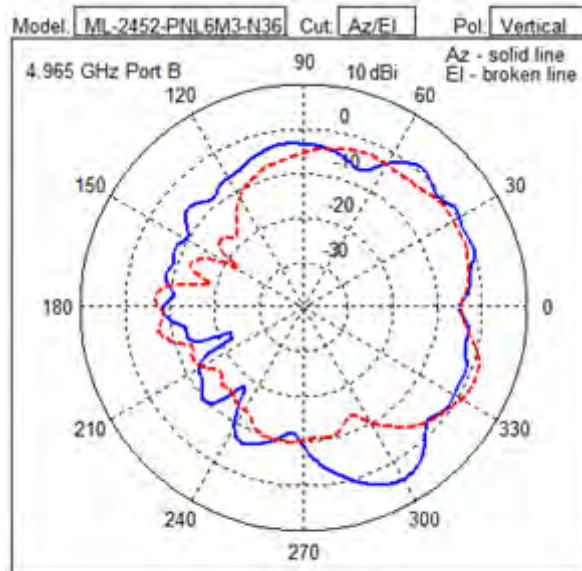
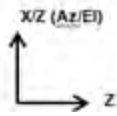
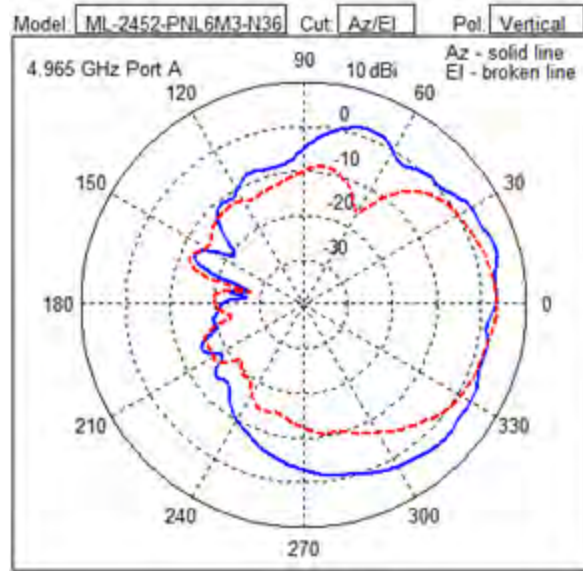



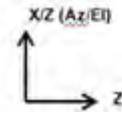
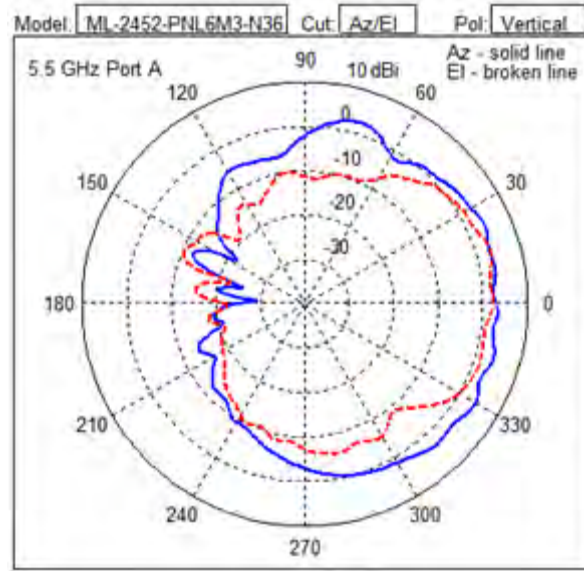
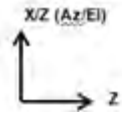
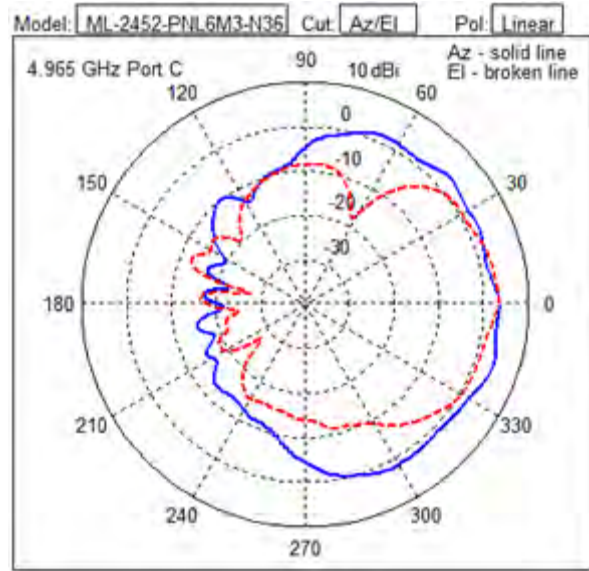

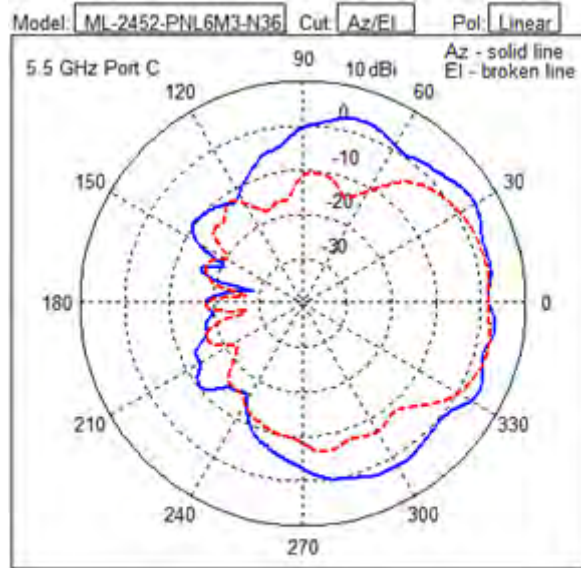
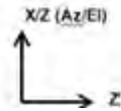
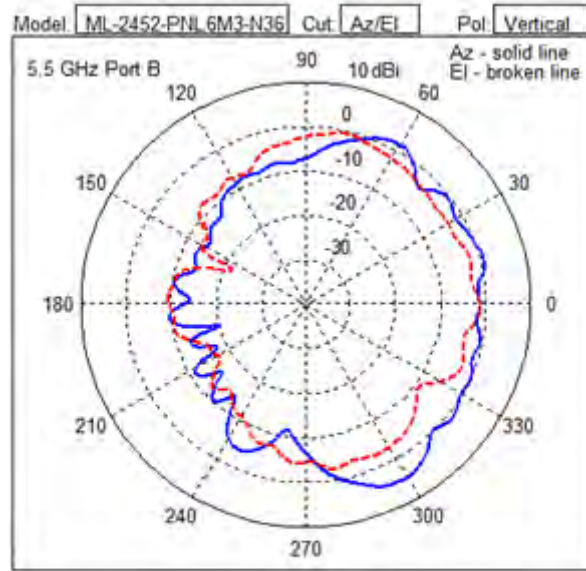

**5.1.25 ML-2452-SEC6M3-N36, 11ABGN, 3-Port, Multi-Pol, Dir Panel, 6.5/5.0 dBi, LP, CBL 36, N-Type-M**

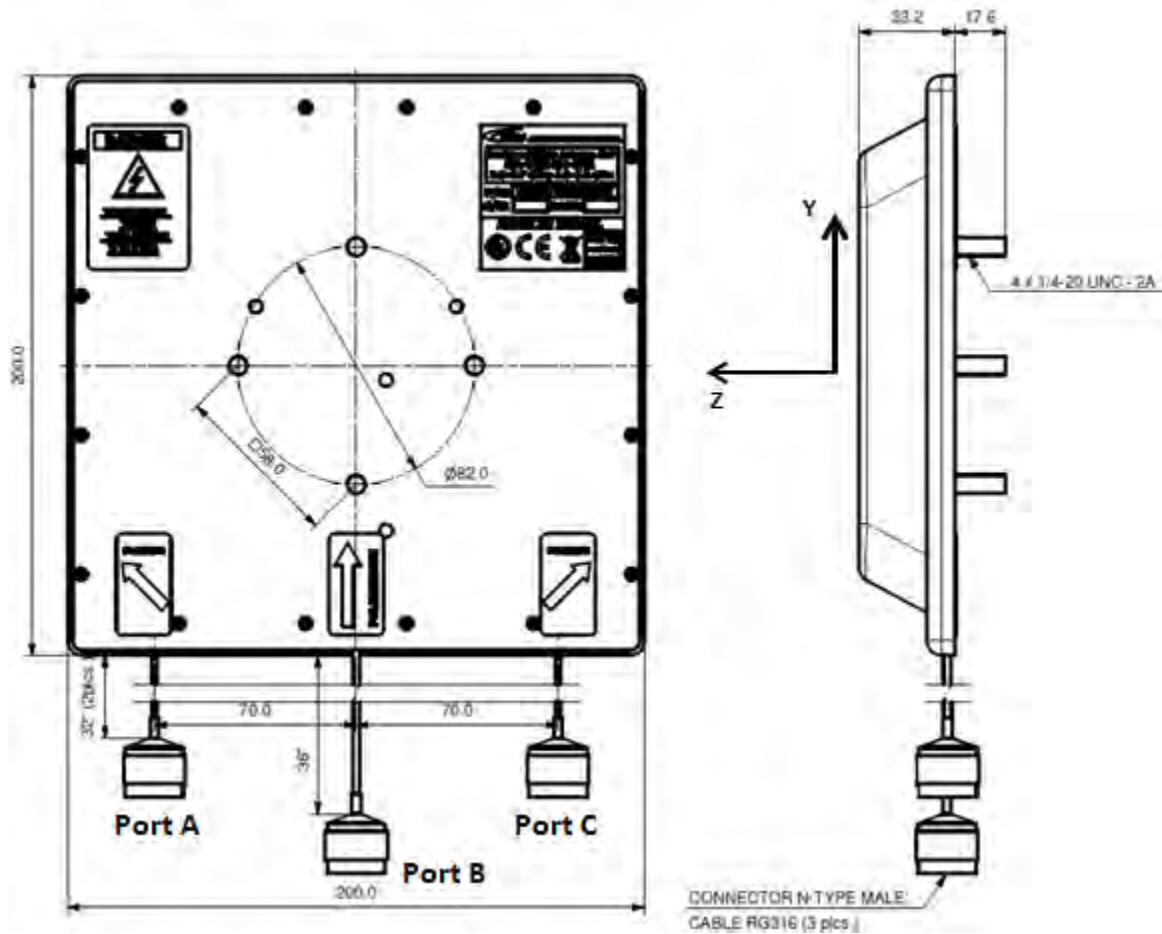

Type	Polarized Panel
Frequency	2300-2700, 4900-6100 MHz
Max Gain (dBi)	6.5/5.0 (2.4GHz/5GHz)
Polarization	Port A -Slant Linear Port B -Vertical, Linear Port C -Slant Linear
Azimuth 3 dB Beamwidth:	Port A - 90°/90° Port B - 120°/140° Port C - 90°/90°
Elevation 3 dB Beamwidth:	Port A - 90°/90° Port B - 70°/80° Port C - 90°/90°
Cable Length (centimeters)	98
Cable Type	RG316, 98

Connector Type	N-Type Male x 3
Antenna Plenum Rated	Yes
Cable Plenum Rated	N/A
Outdoor Rated	Yes
Weight (kgs)	0.88
Storage Temp Range (C)	-40°/70°
Operation Temp Range (C)	-40°/70°

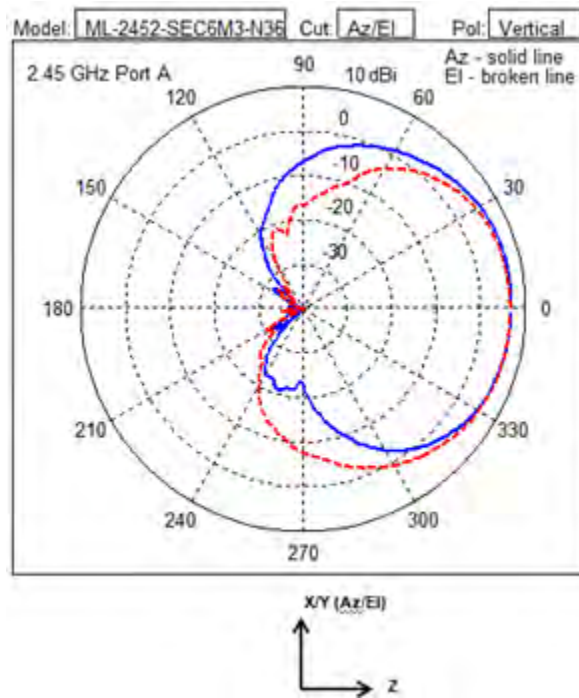

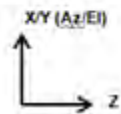
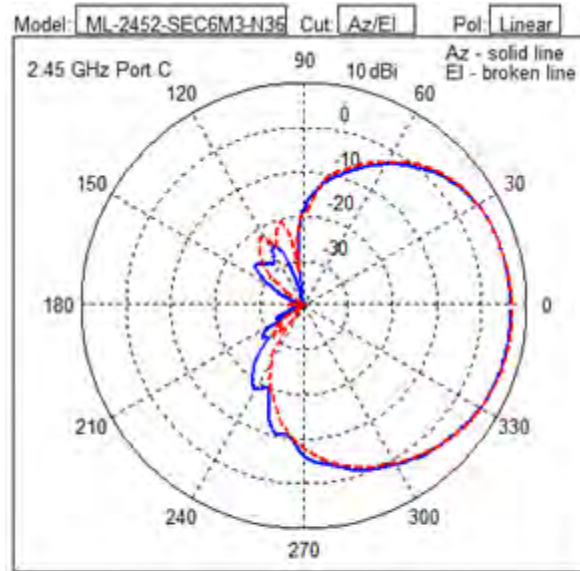
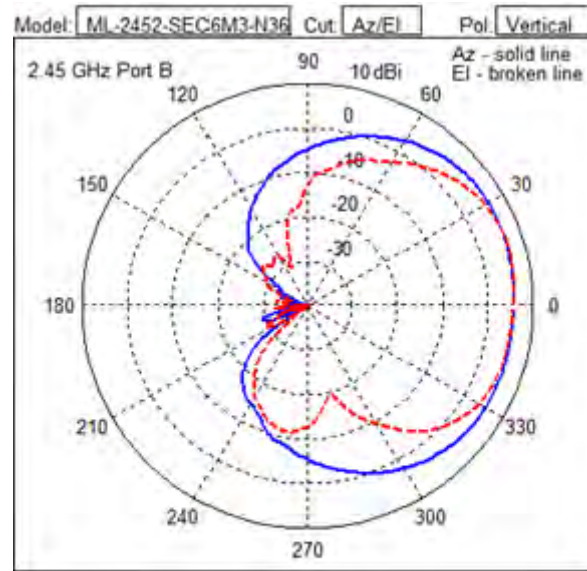

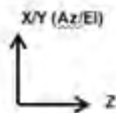
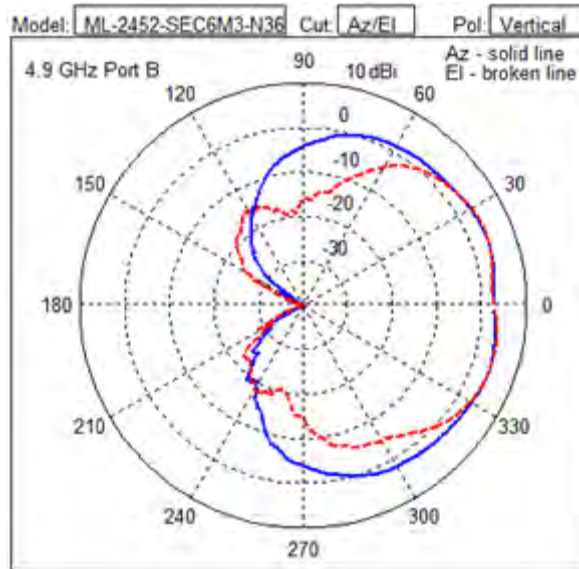
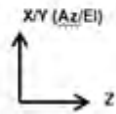
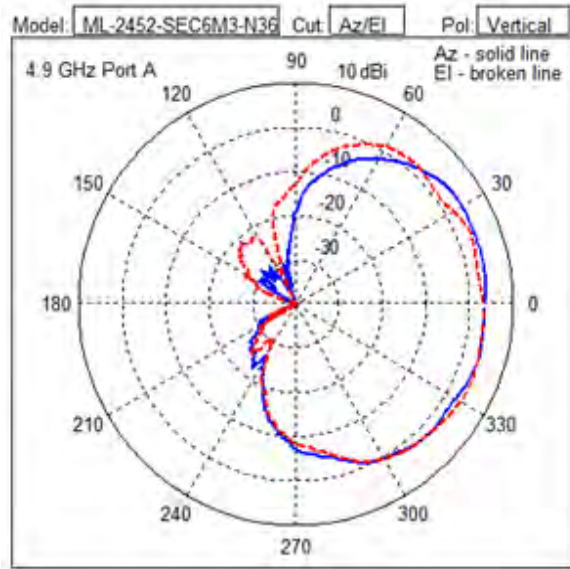

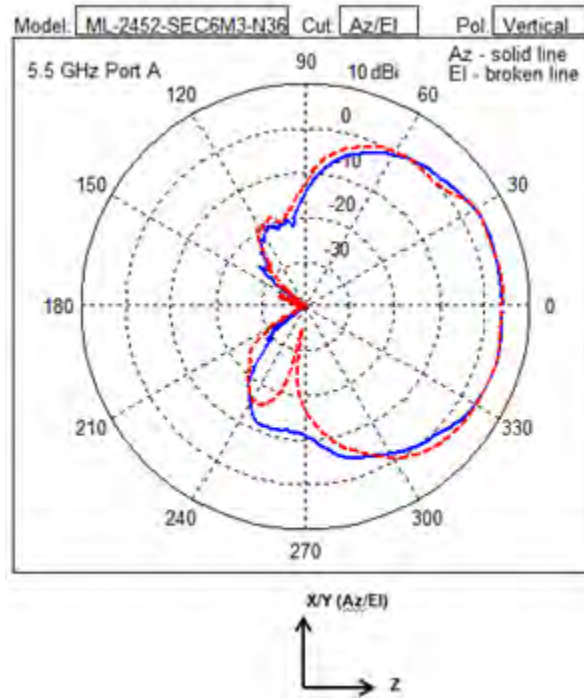
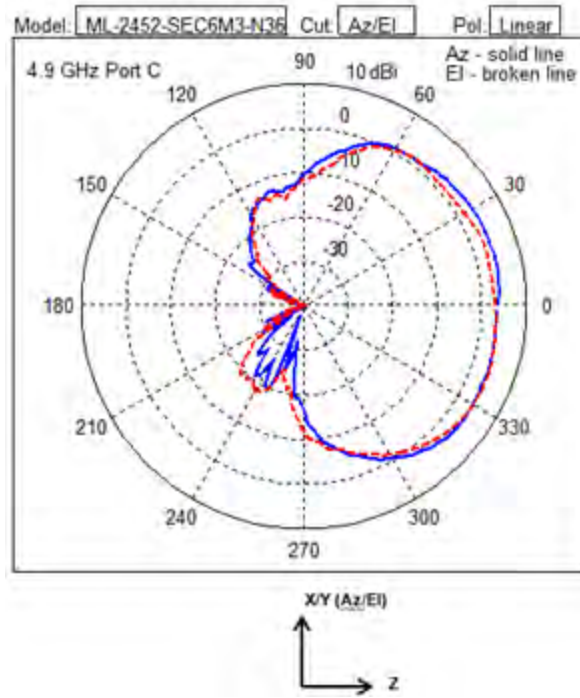

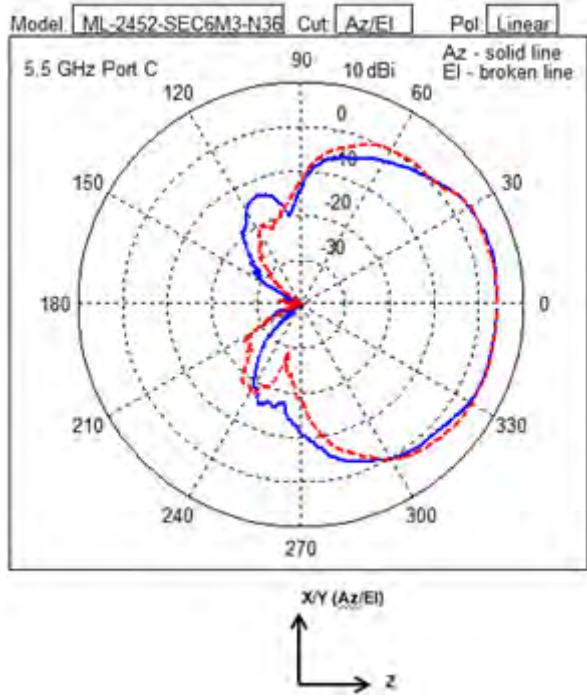
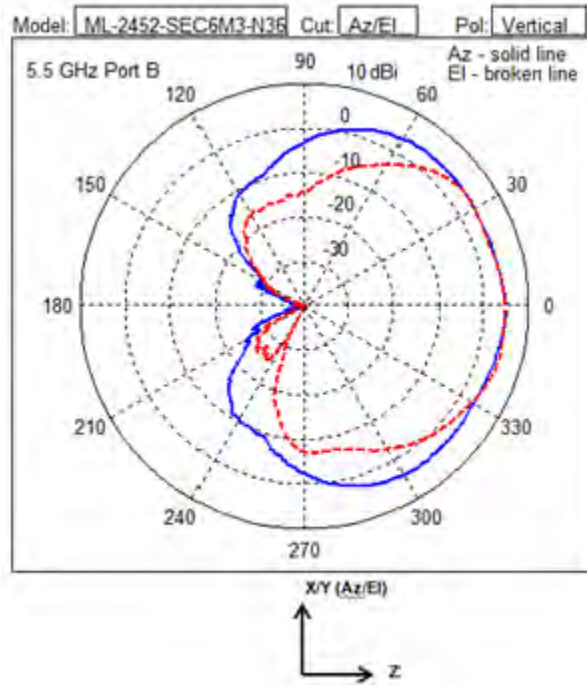



**5.1.26 ML-2452-VMM5M3-N72, 11ABGN, 3-Port Dual-Band, Vertical Polarization Omni Array**

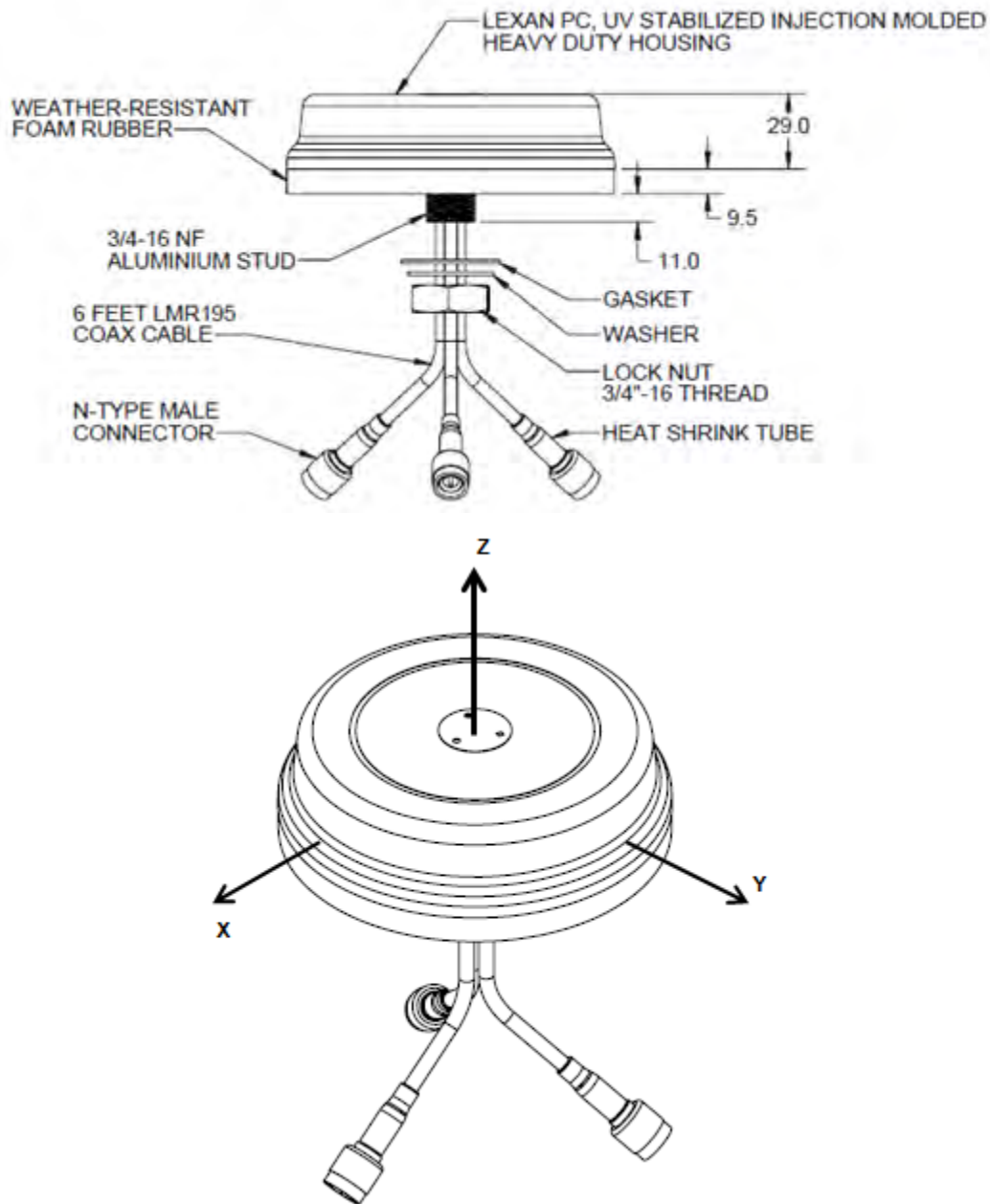

Type	Dipole
Frequency	2400-2500, 4900-5875 MHz
Max Gain (dBi)	4.5/5.4 (2.4GHz/5GHz)
Polarization	Port A -Linear, Vertical Port B -Linear, Vertical Port C -Linear, Vertical

<i>Azimuth</i> 3 dB Beamwidth:	Port A - 360°/360° Port B - 360°/360° Port C - 360°/360°
<i>Elevation</i> 3 dB Beamwidth:	Port A - 40°/30° Port B - 40°/30° Port C - 40°/30°
<i>Cable Length (centimeters)</i>	182.8
<i>Cable Type</i>	LMR195 equivalent
<i>Connector Type</i>	N-Type Male x 3
<i>Antenna Plenum Rated</i>	No
<i>Cable Plenum Rated</i>	N/A
<i>Outdoor Rated</i>	Yes
<i>Weight (kgs)</i>	0.61
<i>Storage Temp Range (C)</i>	-35°/80°
<i>Operation Temp Range (C)</i>	-35°/80°

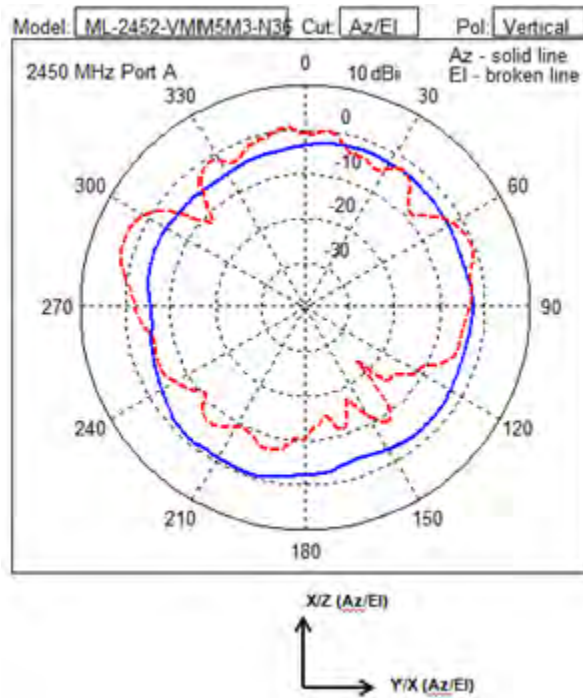

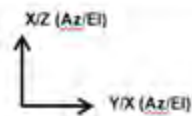
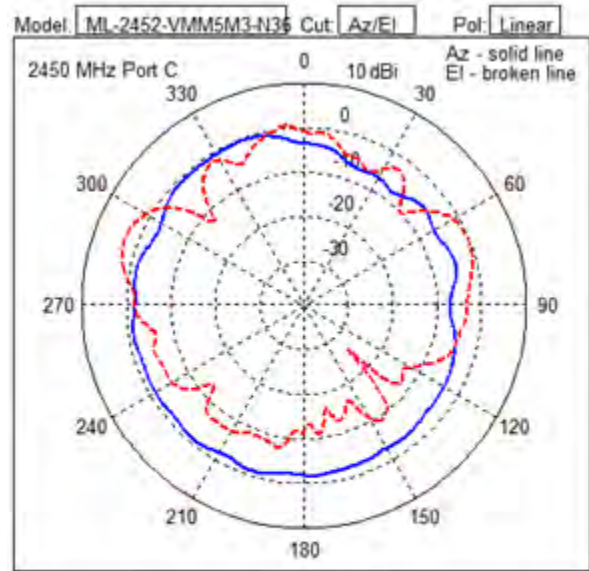
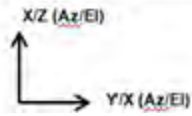
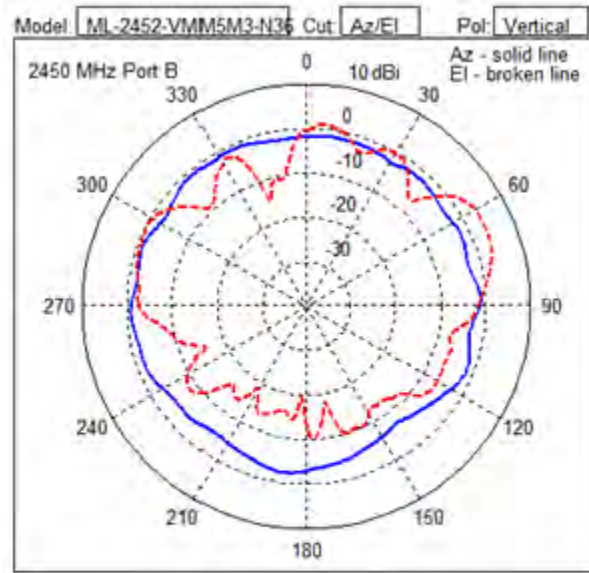

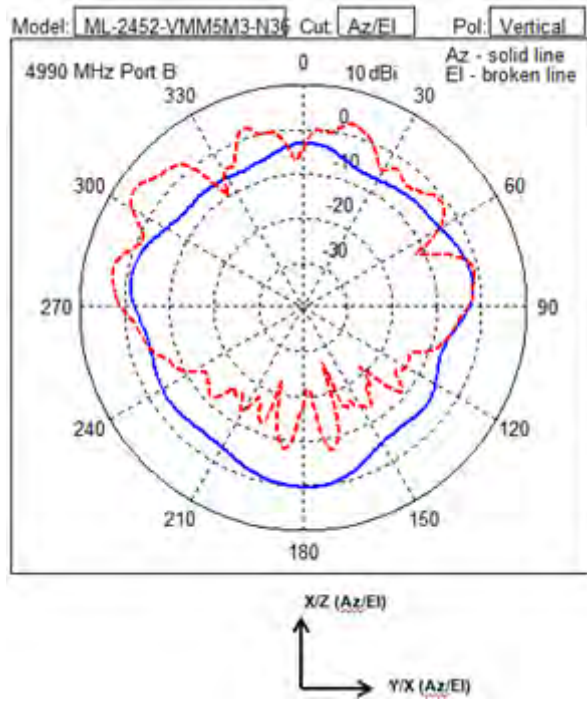
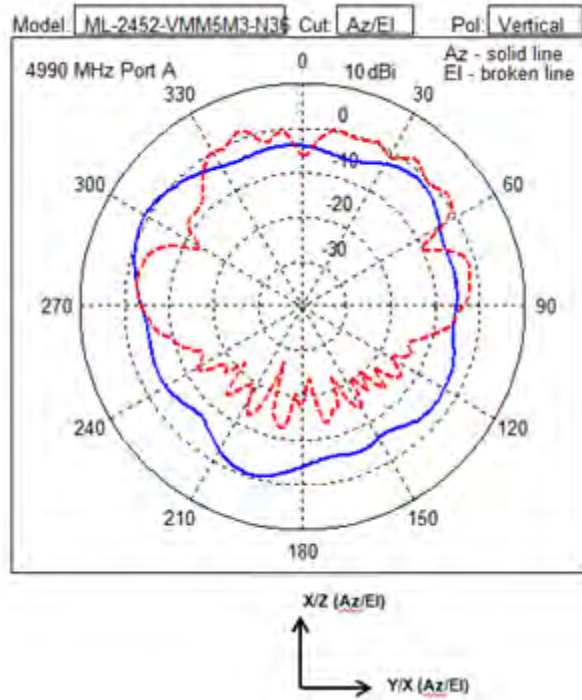

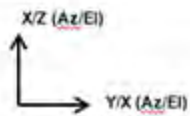
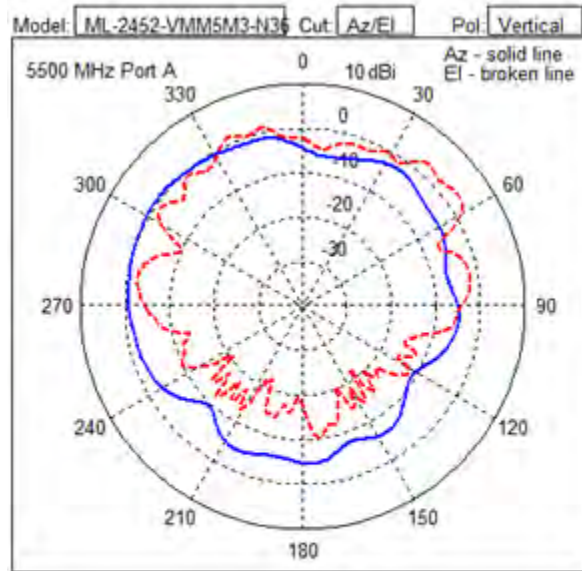
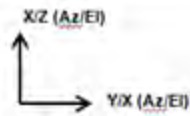
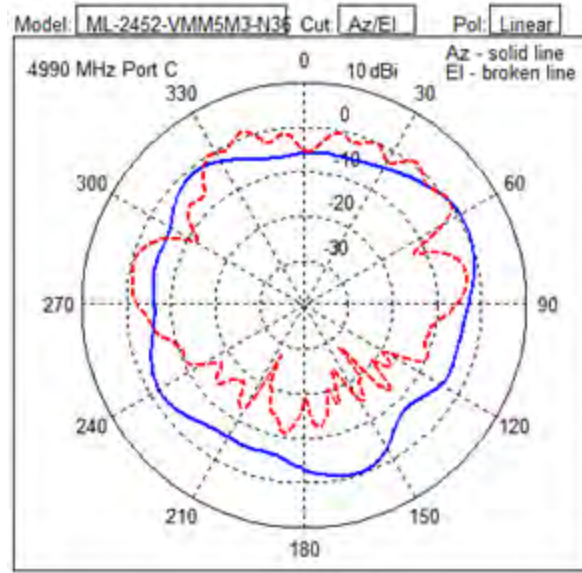

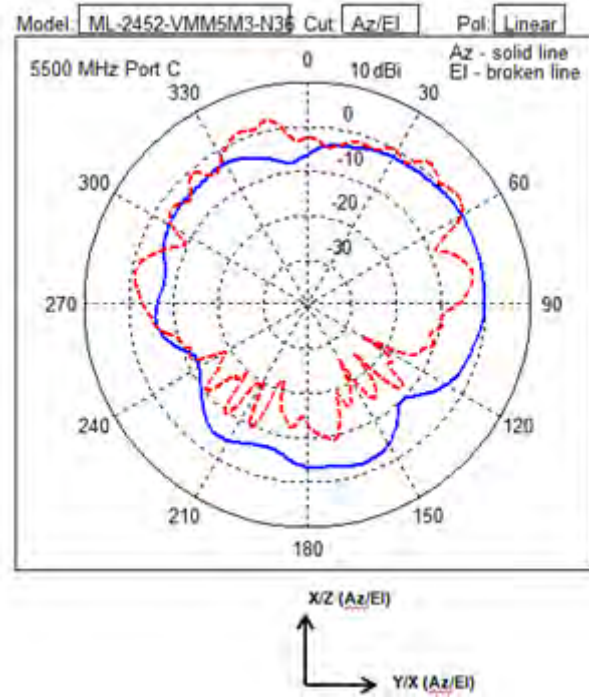
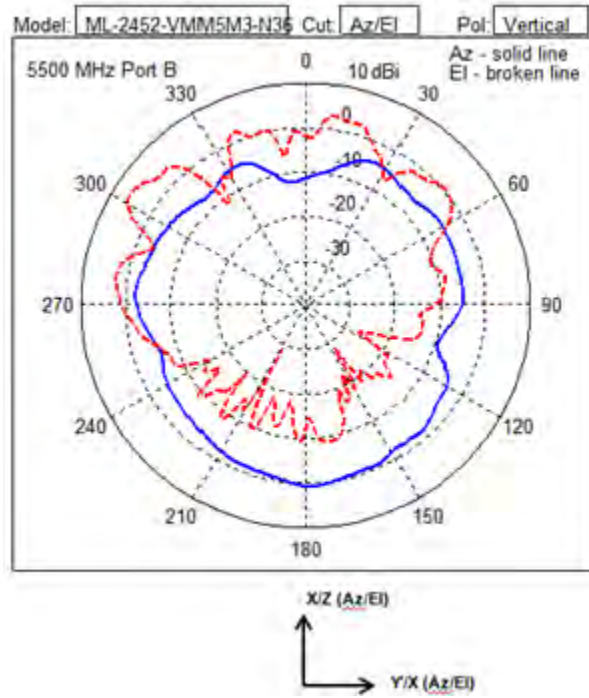

**5.1.27 ML-2452-PNL9M3-N36, 11ABGN, 3-Port Dual-Band, Dual Polarization Dir Panel 2 V-Pol and 1 H-Pol ports**

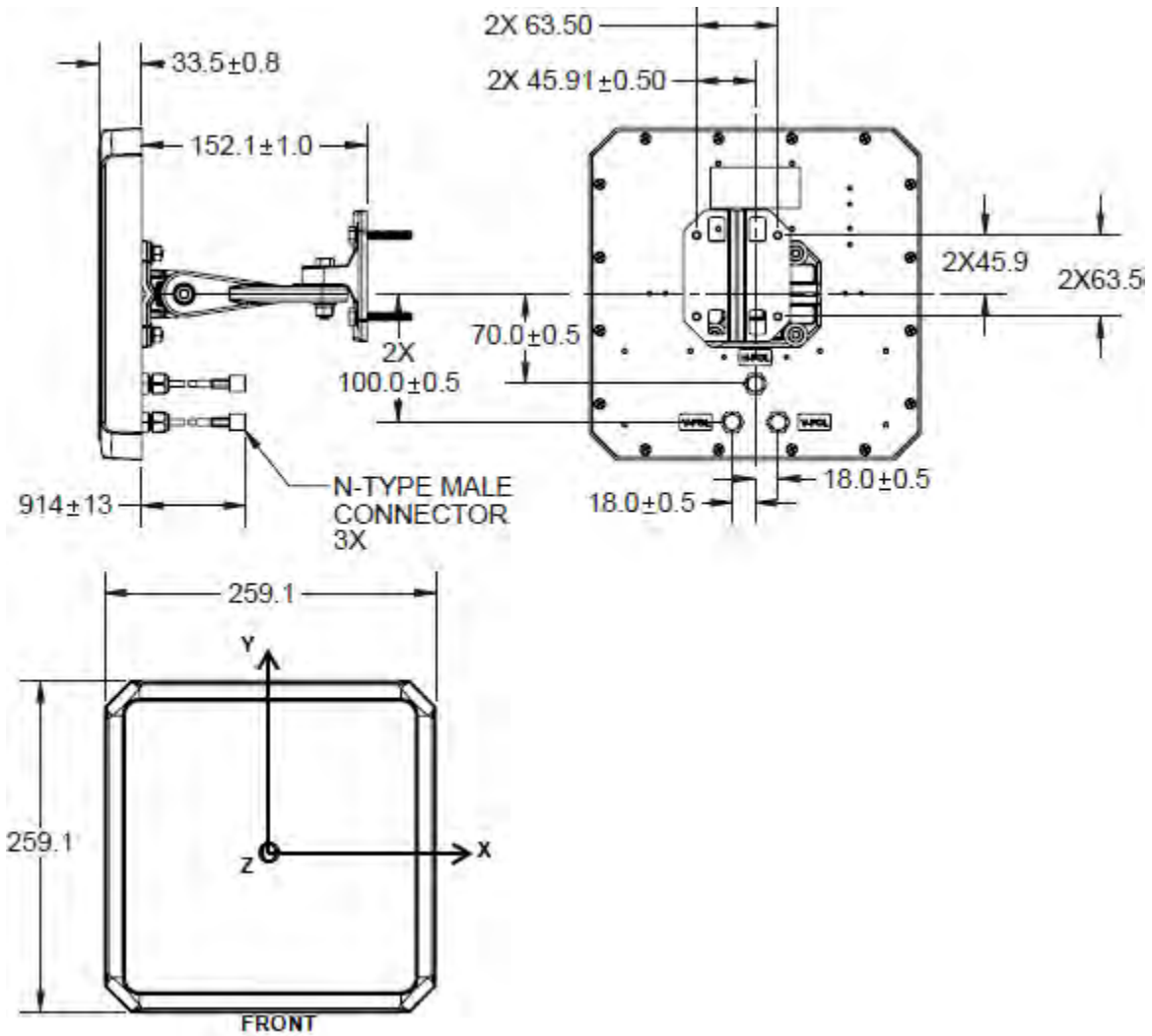

Type	Polarized Panel
Frequency	2400-2500, 5150-5875 MHz
Max Gain (dBi)	11.0/10.7 (2.4GHz/5GHz)
Polarization	Port A -Linear, Vertical Port B -Linear, Horizontal Port C -Linear, Vertical
Azimuth 3 dB Beamwidth:	Port A - 75°/55° Port B - 75°/55° Port C - 75°/55°

<i>Elevation 3 dB Beamwidth:</i>	Port A - 70°/60° Port B - 70°/60° Port C - 70°/60°
<i>Cable Length (centimeters)</i>	91
<i>Cable Type</i>	LMR195 equivalent
<i>Connector Type</i>	N-Type Male x 3
<i>Antenna Plenum Rated</i>	No
<i>Cable Plenum Rated</i>	N/A
<i>Outdoor Rated</i>	Yes
<i>Weight (kgs)</i>	0.80
<i>Storage Temp Range (C)</i>	-40°/70°
<i>Operation Temp Range (C)</i>	-30°/65°

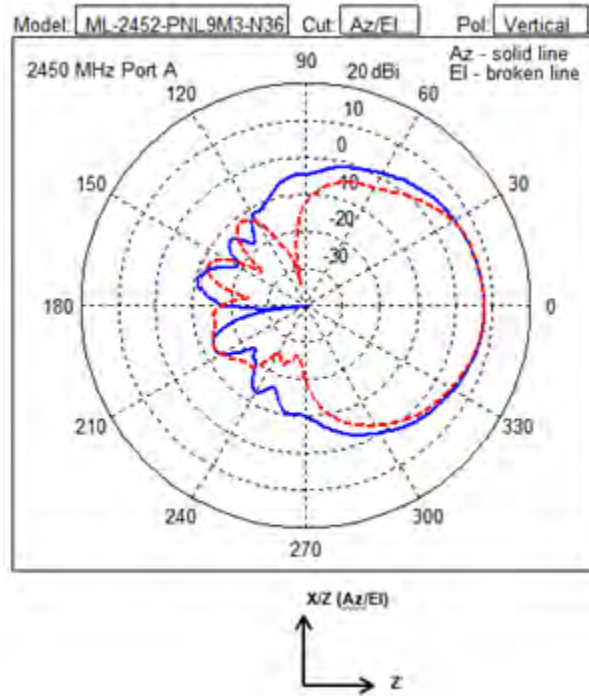



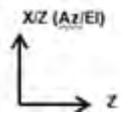
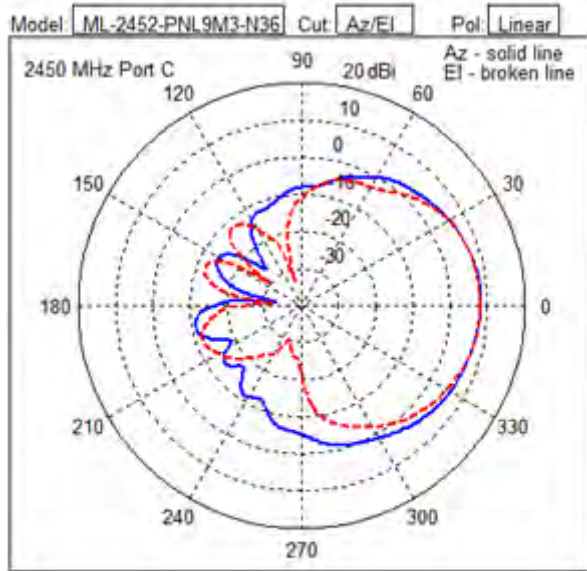
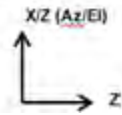
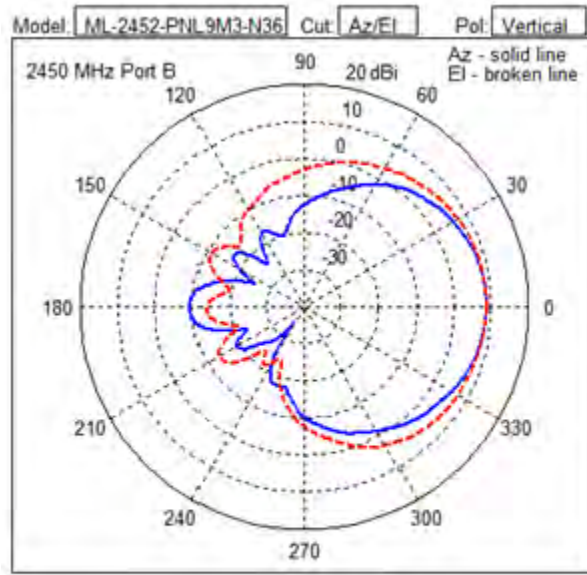

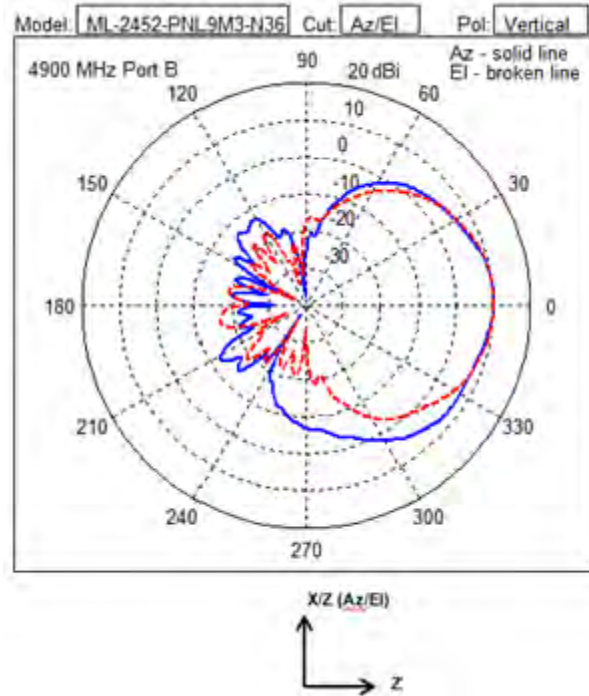
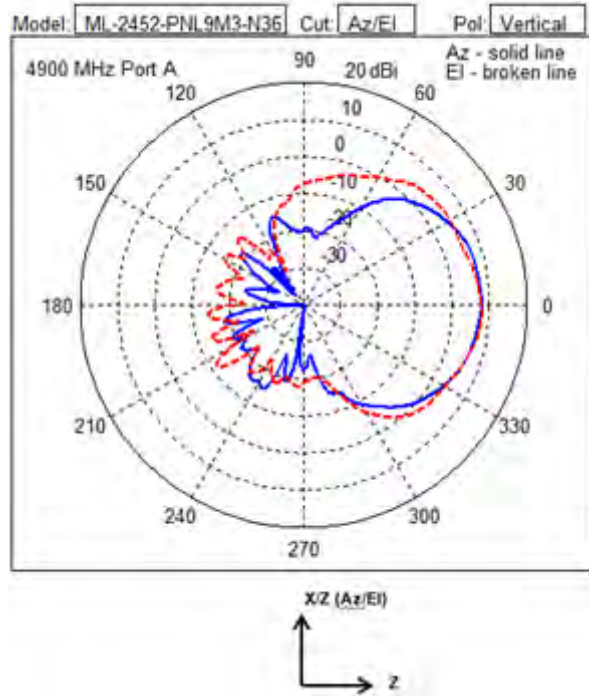

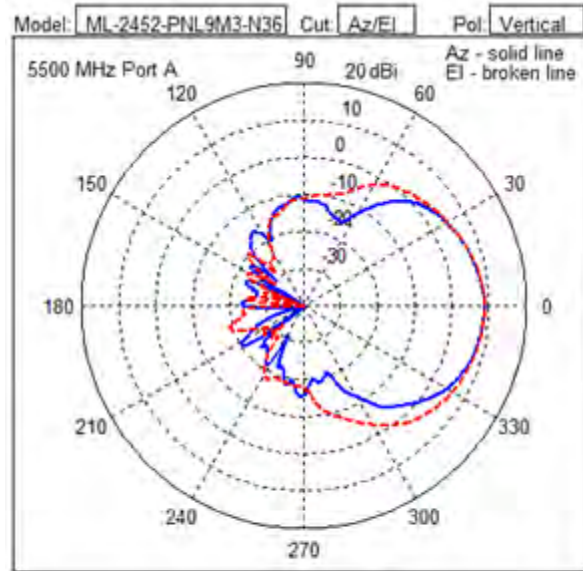
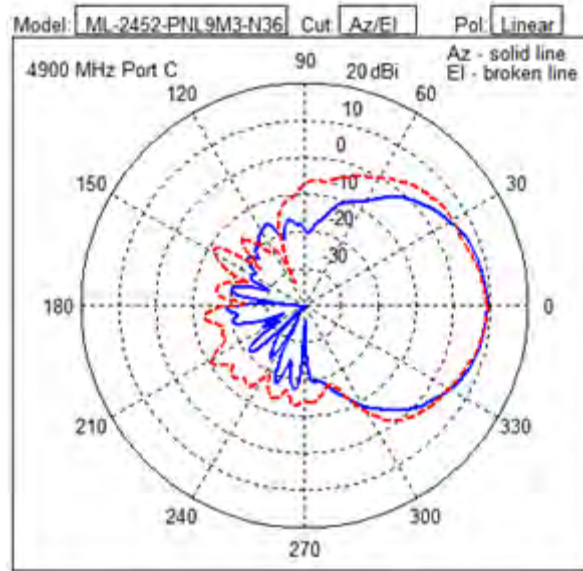

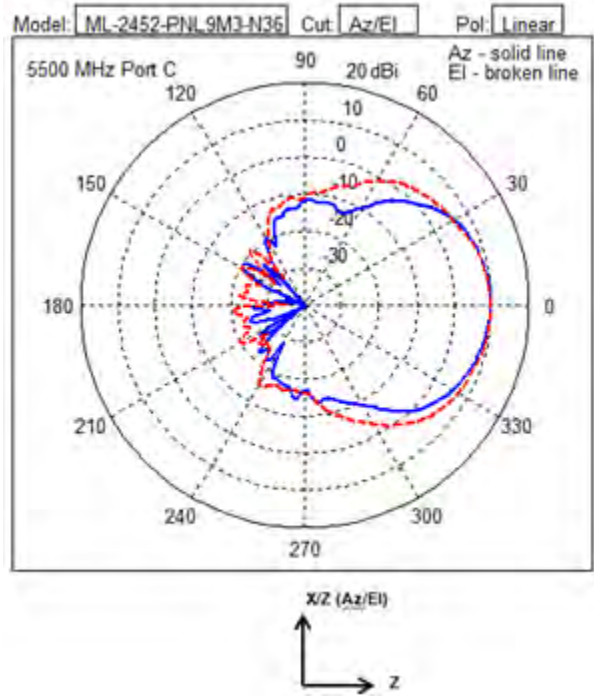
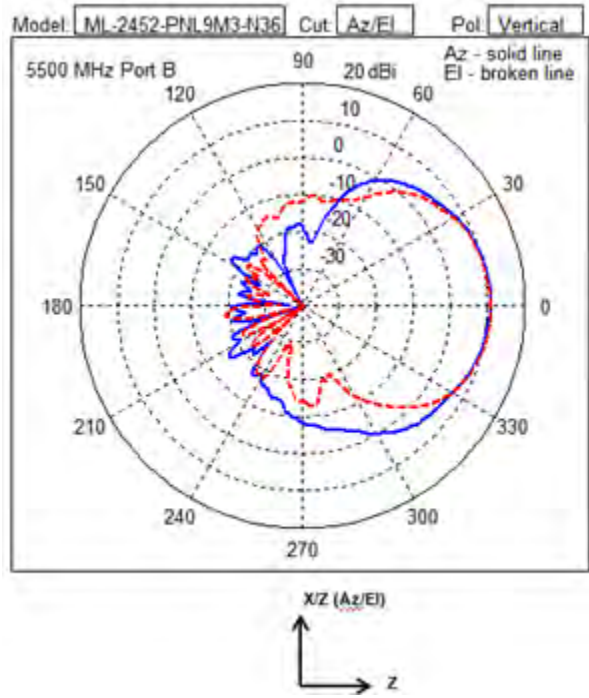

# 6

## ***Antenna Cables***

### **6.1 Supported Antenna Cables**

Numerous cables are supported to suit your unique access point or access port deployment. Check the Support site periodically, as new cables will be added to this document as they are released.

For detailed information on supported cables, refer to:

- *ML-1499-10JK-01R 10 ft. Low-Loss Coaxial Cable Jumper: N Male to N Male*
- *ML-1499-25JK-01R 25 ft. Low-Loss Coaxial Cable Jumper: N Male to N Male with 2 Connector Seal Kits*

**6.1.1 ML-1499-10JK-01R 10 ft. Low-Loss Coaxial Cable Jumper: N Male to N Male**

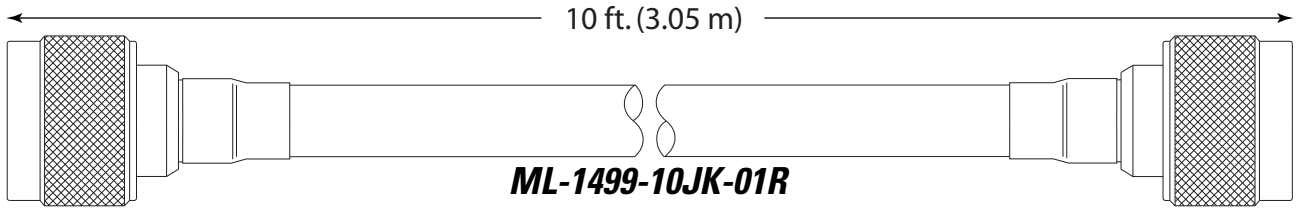

Type	Ultralink TL 93605
RF Connectors	N (m) to N (m)
Cable Attenuation (dB)	2.0 @ 2.4 GHz; 2.9 @ 5.8 GHz
Frequency	2 - 6 GHz

**6.1.2 ML-1499-25JK-01R 25 ft. Low-Loss Coaxial Cable Jumper: N Male to N Male with 2 Connector Seal Kits**

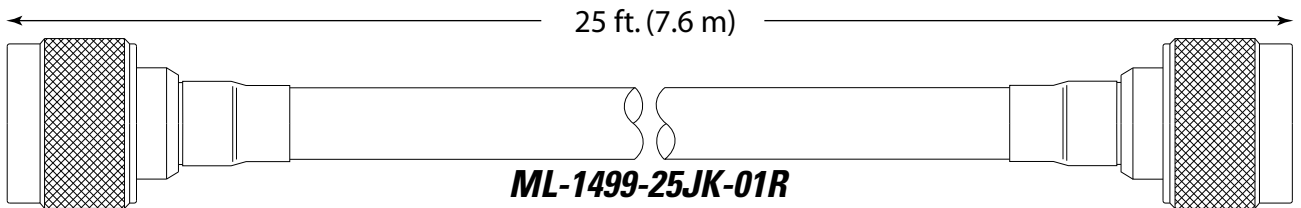

Type	Ultralink TL 93605
RF Connectors	N (m) to N (m)
Cable Attenuation (dB)	2.5 @ 2.4 GHz; 4.0 @ 5.8 GHz
Frequency	2 - 6 GHz

## ***Supported Antenna Adapters***

### **7.1 Supported Adapters**

Numerous adapters are supported to suit your unique access point deployment. Check the Support site periodically, as new adapters will be added to this document as they are released.

For detailed information on supported antenna adapters, refer to:

- *25-85391-01R 3.5 in. Jumper Cable, RP-SMA (Male) to Type N (Male) Adaptor*
- *25-85392-01R 3.5 in. Jumper Cable, RP-SMA (Male) to Type N (Female) Adaptor*
- *25-72178-01 Jumper, RP-SMA(M) to RP-BNC(F)*
- *25-90262-01R RP-SMA (Female) to Type N (Female) Adapter*
- *25-90263-01R Type N (Male) to RP-SMA (Female) Bulkhead Adapter*
- *25-99175-01R Type N, Female to Female Adaptor*

**7.1.1 25-85391-01R 3.5 in. Jumper Cable, RP-SMA (Male) to Type N (Male) Adaptor**

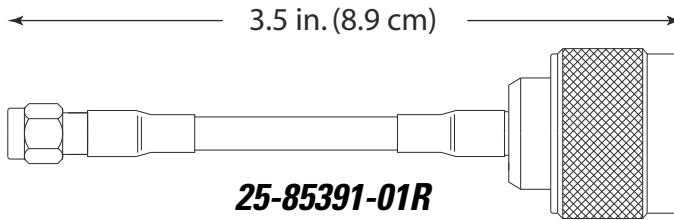

Type	Clear Jacket, RG-316
Connector 1	RP-SMA, Male
Connector 2	Type N, Male
Insertion Loss	2.4 GHz: 0.2 dB MIN
Insertion Loss	5.2 GHz: 0.3 dB MIN

**7.1.2 25-85392-01R 3.5 in. Jumper Cable, RP-SMA (Male) to Type N (Female) Adaptor**

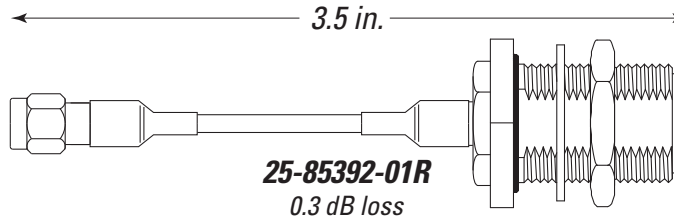

Type	Clear Jacket, RG-316
Connector 1	RP-SMA, Male
Connector 2	Type N, Female, Bulkhead
Insertion Loss	2.4 GHz: 0.2 dB MIN
Insertion Loss	5.2 GHz: 0.3 dB MIN

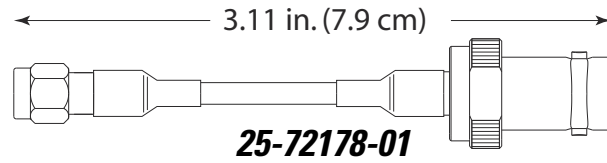

**7.1.3 25-72178-01 Jumper, RP-SMA(M) to RP-BNC(F)**

Type	RG-316
Connector 1	RP-SMA, Male
Connector 2	RP-BNC, Female
Insertion Loss	2.4 GHz: .2 dB
Insertion Loss	5.2 GHz: .3 dB

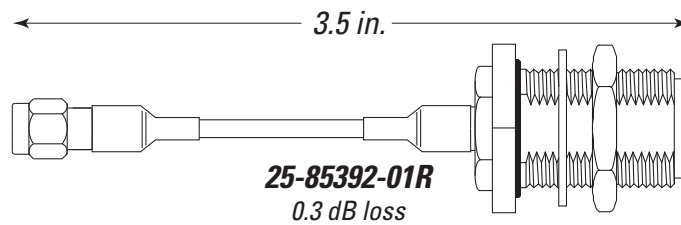
**7.1.4 25-90262-01R RP-SMA (Female) to Type N (Female) Adapter**

Type	RG-316
Connector 1	RP-SMA, Female, Bulkhead
Connector 2	Type N, Female, Bulkhead
Insertion Loss	2.4 GHz: .2 dB
Insertion Loss	5.2 GHz: .3 dB

### 7.1.5 25-90263-01R Type N (Male) to RP-SMA (Female) Bulkhead Adapter

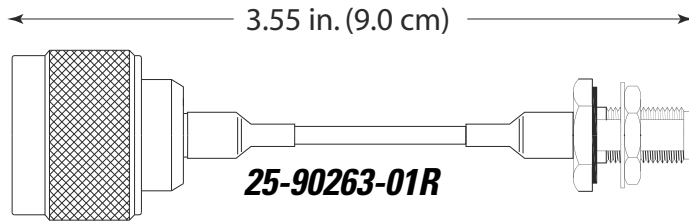

Type	RG-316
Connector 1	Type N, Male
Connector 2	RP-SMA, Female, Bulkhead
Insertion Loss	2.4 GHz: 0.2 dB MIN
Insertion Loss	5.2 GHz: 0.3 dB MIN

### 7.1.6 25-99175-01R Type N, Female to Female Adaptor

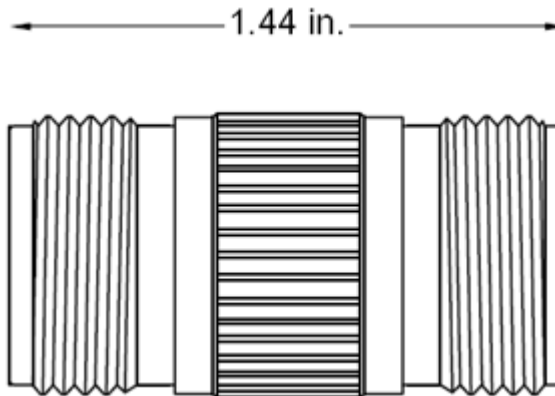

Connector 1	Type N, Female
Connector 2	Type N, Female
Cable Loss (dB)	0.3
Cable Length (inches)	1.44

## *Supported Lightning Arrestors*

### 8.1 Lightning Arrestors

Several lightning arrestors are available to support your unique access point deployment safety requirements. Check the Support site periodically, as new lightning arrestors will be added to this document as they are released.

For detailed information on supported lightning arrestors refer to:

- [\*ML-1499-LAK1-01R 1 ft. N Male to RP BNC Male Lightning Arrestor with Connector Seal Kit\*](#)
- [\*ML-2452-LAK1-01R Lightning Arrestor \(N Female to N Female\) with N Male to RP-SMA Male Adapter\*](#)
- [\*ML-2452-LAK1-02R Type N, Male-Female\*](#)



**WARNING!** The grounding lug on a lightning arrestor must be grounded in compliance with local electrical codes.

---

**8.1.1 ML-1499-LAK1-01R 1 ft. N Male to RP BNC Male Lightning Arrestor with Connector Seal Kit**

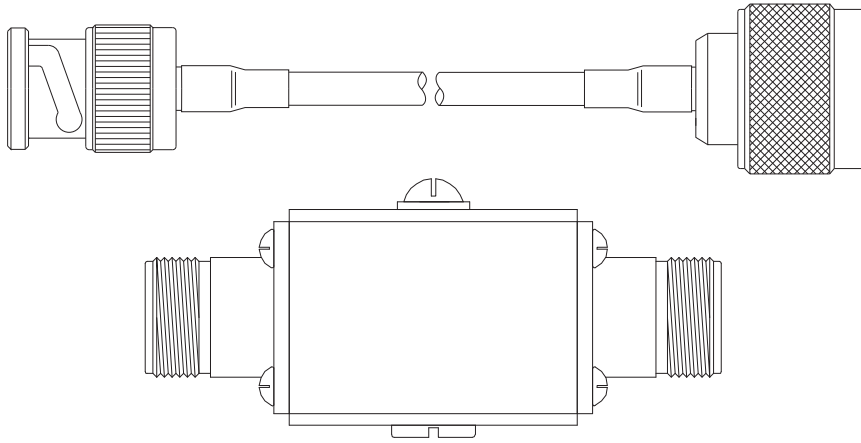

**ML-1499-LAK1-01R**

<i>Cable</i>	Black, Ultralink, RG-58
<i>RF Connectors</i>	N (m) to RP. BNC (m)
<i>Arrestor RF Connectors</i>	N (f) to N (f)
<i>Frequency</i>	2400-2500 MHz
<i>Insertion Loss - Lightning Arrestor</i>	0.25 dB @ 2.4 GHz
<i>Insertion Loss - Cable</i>	0.6 dB @ 2.4 GHz



**NOTE:** Not for use above 2500 MHz.

### 8.1.2 ML-2452-LAK1-01R Lightning Arrestor (N Female to N Female) with N Male to RP-SMA Male Adapter

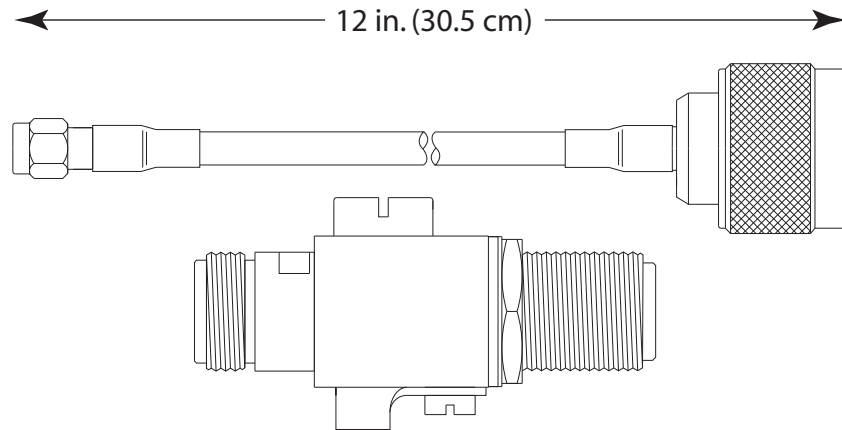

**ML-2452-LAK1-01R**

<i>Cable</i>	Black, Ultralink, RG-58
<i>Connectors - Cable</i>	N (m) to RP. SMA (m)
<i>Frequency</i>	100-6000 MHz
<i>Insertion Loss - Cable</i>	0.6 @ 2.4 GHz, 1.4 @ 5.5 GHz
<i>Insulation Resistance</i>	50 M-ohms
<i>Connectors - Lightning Arrestor</i>	Type N (f) to N (f)
<i>Weight</i>	4.5 oz
<i>Operating Temperature</i>	- 40° to 85°C
<i>Insertion Loss - Lightning Arrestor</i>	0.14 @ 2.4 GHz, 0.35 @ 5.5 GHz

### 8.1.3 ML-2452-LAK1-02R Type N, Male-Female

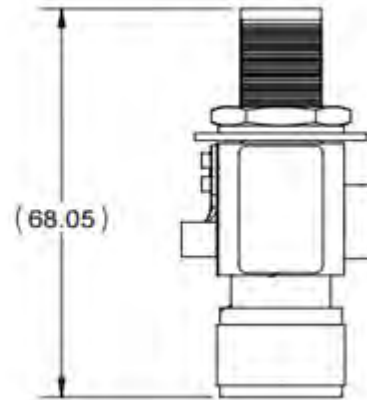
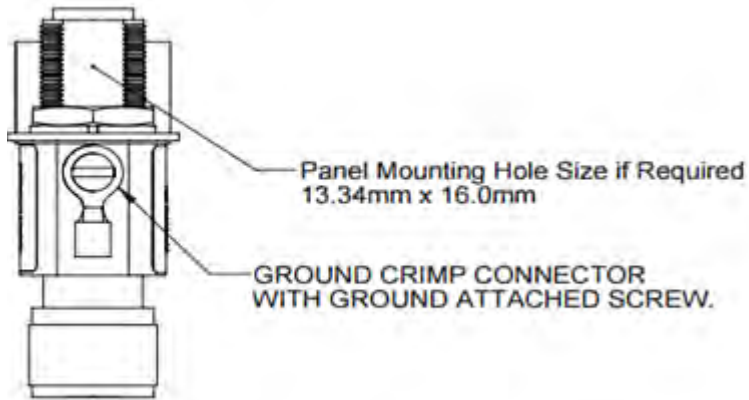

<i>RF Connector</i>	Type N, Male-Female
<i>Frequency</i>	100-6000 MHz
<i>Insertion Loss</i>	0.4dB Max

# 9

## ***Mounting Kits***

### **9.1 Mounting Kit Support**

Mounting kits are available to support your unique access point deployment. Check the Support site periodically, as new kits will be added to this document as they are released.

For detailed information on supported mounting kits refer to:

- [\*ML-1499-SD3MK-01R Articulating I-Beam Mount Kit for ML-2499-SD3-01 Omni Antenna\*](#)

### 9.1.1 ML-1499-SD3MK-01R Articulating I-Beam Mount Kit for ML-2499-SD3-01 Omni Antenna

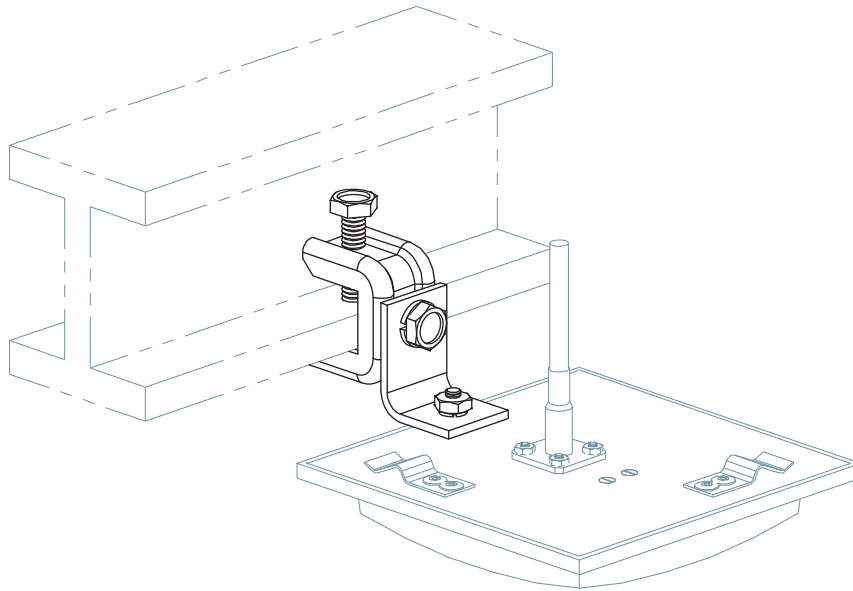

<i>Functionality</i>	Mounts Part No. ML-2499-SD3-01 to an I-beam.
----------------------	--



## ***AP7131 Regulatory Domains***

### **10.1 Supported Antennas by Band, Model, Rate and Transmit Power**

Refer to the following AP7131 supported antennas for their US Regulatory Domain transmit power (in both the 2.4 and 5.2 GHz bands), rates and supported channels.

#### *US Regulatory Domain 2.4 GHz Band*

- *Yagi Antenna Models*
  - *Yagi Antenna Maximum Conducted Transmit Power Settings*
- *Panel Antenna Models*
  - *Panel Antenna Maximum Conducted Transmit Power Settings*
- *Embedded Antenna Models*
  - *Embedded Antenna Maximum Conducted Transmit Power Settings*
- *Dipole Antenna Models*
  - *Dipole Antenna Maximum Conducted Transmit Power Settings*
- *Patch Antenna Models*
  - *Patch Antenna Maximum Conducted Transmit Power Settings*

#### *US Regulatory Domain 5.2 GHz Band*

- *Yagi Antenna Models*
  - *Yagi Antenna Maximum Conducted Transmit Power Settings*
- *Panel Antenna Models*
  - *Panel Antenna Maximum Conducted Transmit Power Settings*
- *Embedded Antenna Models*
  - *Embedded Antenna Maximum Conducted Transmit Power Settings*
- *Dipole Antenna Models*
  - *Dipole Antenna Maximum Conducted Transmit Power Settings*
- *Patch Antenna Models*
  - *Patch Antenna Maximum Conducted Transmit Power Settings*

## 10.2 US Regulatory Domain 2.4 GHz Band

### 10.2.1 2.4 GHz Mode Versus Data Rate

When setting 2.4 GHz data rates using the access point's GUI applet, use the following chart to cross reference data rates to the radio's selected operational mode.

	<i>B, G and N</i>	<i>G and N</i>	<i>N Only</i>	<i>B and G</i>	<i>G Only</i>	<i>B Only</i>
<b>LEGACY DSSS RATES (1, 2, 5.5, 11 MBPS)</b>	X			X		X
<b>LEGACY OFDM RATES (6,9,12,18,24,36,48,54 MBPS)</b>	X	X		X	X	
<b>802.11n HT20 RATES (MCS 0 MCS 15)</b>	X	X	X			
<b>802.11n HT40 RATES (MCS 0 MCS15)</b>	X	X	X			

### 10.2.2 Yagi Antenna Models

The following is the Yagi antenna model for 2.4 GHz:

<i>Part Number</i>
ML-2499-BYGA2-01R

#### 10.2.2.1 Yagi Antenna Maximum Conducted Transmit Power Settings

The following is a transmit power table (US domain) per Yagi antenna in the 2.4 GHz band:

<i>20 MHZ CHANNEL</i>	<i>40 MHZ CHANNEL</i>	<i>LEGACY DSSS RATES (1, 2, 5.5, 11 MBPS)</i>	<i>LEGACY OFDM RATES (6,9,12,18,24,36, 48,54 MBPS)</i>	<i>802.11n HT20 RATES (MCS 0 MCS 15)</i>	<i>802.11n HT40 RATES (MCS 0 MCS15)</i>
1		13	7	7	
2		13	7	7	
3	(1, 5)	13	7	7	2
4	(2, 6)	13	7	7	2
5	(3, 7)	13	7	7	2
6	(4, 8)	13	8	8	5
7	(5, 9)	12	7	6	2
8	(6, 10)	12	7	6	2
9	(7, 11)	12	7	6	2
10		12	7	6	
11		12	7	6	

With the most recent AP7131 series software release (4.0.0.0) the Web browser of the command line interface do not allow setting the transmit power to any value less than 4dBm.



**NOTE:** When a Yagi antenna is used, a 2dB external RF attenuator must be added. Lower power settings will be provided in subsequent software releases.

### 10.2.3 Panel Antenna Models

The following is the panel antenna model for 2.4 GHz:

<i>Part Number</i>
ML-2452-PTA3M3-036

#### 10.2.3.1 Panel Antenna Maximum Conducted Transmit Power Settings

The following is a transmit power table (US domain) per panel antenna in the 2.4 GHz band:

<b>20 MHZ CHANNEL</b>	<b>40 MHZ CHANNEL</b>	<b>LEGACY DSSS RATES (1, 2, 5.5, 11 MBPS)</b>	<b>LEGACY OFDM RATES (6,9,12,18,24,36, 48,54 MBPS)</b>	<b>802.11n HT20 RATES (MCS 0 MCS 15)</b>	<b>802.11n HT40 RATES (MCS 0 MCS15)</b>
1		16	11	10	
2		16	11	10	
3	(1, 5)	16	11	10	7
4	(2, 6)	16	11	10	7
5	(3, 7)	16	11	10	7
6	(4, 8)	16	11	11	8
7	(5, 9)	16	11	9	5
8	(6, 10)	16	11	9	5
9	(7, 11)	16	11	9	5
10		16	11	9	
11		16	11	9	

## 10.2.4 Embedded Antenna Models

The following is the embedded antenna model for 2.4 GHz:

<b>Part Number</b>
ML-2452-PTA2M3X3-1

### 10.2.4.1 Embedded Antenna Maximum Conducted Transmit Power Settings

The following is a transmit power table (US domain) per embedded antenna in the 2.4 GHz band:

<b>20 MHZ CHANNEL</b>	<b>40 MHZ CHANNEL</b>	<b>LEGACY DSSS RATES (1, 2, 5.5, 11 MBPS)</b>	<b>LEGACY OFDM RATES (6,9,12,18,24,36, 48,54 MBPS)</b>	<b>802.11n HT20 RATES (MCS 0 MCS 15)</b>	<b>802.11n HT40 RATES (MCS 0 MCS15)</b>
1		20	16	16	
2		20	16	16	
3	(1, 5)	20	16	16	11
4	(2, 6)	20	16	16	11
5	(3, 7)	20	16	16	11
6	(4, 8)	18	14	14	12
7	(5, 9)	16	15	15	12
8	(6, 10)	16	15	15	12
9	(7, 11)	16	15	15	12
10		16	15	15	
11		16	15	15	

## 10.2.5 Dipole Antenna Models

The following are the dipole antenna models for 2.4 GHz:

<b>Part Number</b>	<b>2.4 GHz Antenna Net Gain</b>
ML-2452-APA2-01	3
ML-2499-HPA3-01R	4.7
ML-2452-APA6J-01 (microcell)	- 6

### 10.2.5.1 Dipole Antenna Maximum Conducted Transmit Power Settings

The following is a transmit power table (US domain) per dipole antenna in the 2.4 GHz band:



**NOTE:** The access point GUI only allows whole numbers be entered for transmit power. The decimal values are displayed within these tables to help installers accommodate for cable and accessory losses.

<b>20 MHZ CHANNEL</b>	<b>40 MHZ CHANNEL</b>	<b>LEGACY DSSS RATES (1, 2, 5.5, 11 MBPS)</b>	<b>LEGACY OFDM RATES (6,9,12,18,24,36, 48,54 MBPS)</b>	<b>802.11n HT20 RATES (MCS 0 MCS 15)</b>	<b>802.11n HT40 RATES (MCS0 MCS15)</b>
1		18.5	15.0	15.0	
2		18.5	15.0	15.0	
3	(1, 5)	18.5	16.0	16.5	10.0
4	(2, 6)	18.5	16.0	16.5	11.0
5	(3, 7)	18.5	16.0	16.0	12.0
6	(4, 8)	23.0	16.0	16.5	13.0
7	(5, 9)	19.0	16.0	16.5	12.0
8	(6, 10)	19.0	16.0	16.5	11.0
9	(7, 11)	19.0	15.0	16.5	9.0
10		19.0	14.0	16.0	
11		19.0	13.5	13.0	

## 10.2.6 Patch Antenna Models

The following is the patch antenna model for 2.4 GHz:

<b>Part Number</b>	<b>2.4 GHz Antenna Net Gain</b>
ML-2452-PTA3M3-036	3

### 10.2.6.1 Patch Antenna Maximum Conducted Transmit Power Settings

The following is a transmit power table (US domain) per patch antenna in the 2.4 GHz band:

<b>20 MHZ CHANNEL</b>	<b>40 MHZ CHANNEL</b>	<b>LEGACY DSSS RATES (1, 2, 5.5, 11 MBPS)</b>	<b>LEGACY OFDM RATES (6,9,12,18,24,36, 48,54 MBPS)</b>	<b>802.11n HT20 RATES (MCS 0 MCS 15)</b>	<b>802.11n HT40 RATES (MCS0 MCS15)</b>
1		16	15	12	
2		16	15	12	
3	(1, 5)	16	15	12	9
4	(2, 6)	16	15	12	9
5	(3, 7)	16	15	12	9
6	(4, 8)	20	15	15	12
7	(5, 9)	18	13	12	10
8	(6, 10)	18	13	12	10
9	(7, 11)	18	13	12	10
10		18	13	12	
11		18	13	12	

## 10.3 US Regulatory Domain 5.2 GHz Band

### 10.3.1 5.2 GHz Mode Versus Data Rate

When setting 5.2 GHz data rates using the access point's GUI applet, use the following chart to cross reference data rates to the radio's selected operational mode.

	<i>A and N</i>	<i>N Only</i>	<i>A Only</i>
<b>LEGACY OFDM RATES</b> (6,9,12,18,24,36,48,54 MBPS)	X		X
<b>802.11n HT20 RATES</b> (MCS 0 MCS 15)	X	X	
<b>802.11n HT40 RATES</b> (MCS 0 MCS 15)	X	X	

### 10.3.2 Yagi Antenna Models

The following is the Yagi antenna model for 5.2 GHz:

<i>Part Number</i>
ML-5299-BYGA15-012

#### 10.3.2.1 Yagi Antenna Maximum Conducted Transmit Power Settings

The following is a transmit power table (US domain) per Yagi antenna in the 5 GHz band:

<b>20 MHZ CHANNEL</b>	<b>40 MHZ CHANNEL</b>	<b>LEGACY OFDM RATES</b> (6,9,12,18,24,36,48,54 MBPS)	<b>802.11n HT20 RATES</b> (MCS 0 MCS 15)	<b>802.11n HT40 RATES</b> (MCS 0 MCS 15)
36		2	2.5	
38	(36, 40)			4
40		2	2.5	
42		2.5	2.5	
44		2.5	2.5	
46	(44, 48)			4
48		2.5	4	
52		9	9	
54	(52, 56)			11
56		9	9	
60		8.5	9	
62	(60, 64)			10
64		8.5	9	
100		8	8.5	

<b>20 MHZ CHANNEL</b>	<b>40 MHZ CHANNEL</b>	<b>LEGACY OFDM RATES (6,9,12,18,24,36,48,54 MBPS)</b>	<b>802.11n HT20 RATES (MCS 0 MCS 15)</b>	<b>802.11n HT40 RATES (MCS 0 MCS 15)</b>
102	(100, 104)			5
104		8	8.5	
108		8	8.5	
112		8	8.5	
110	(108, 112)			11
116		8	8.5	
118	(116, 120)			10
120		8	8.5	
124		7.5	7.5	
126	(124, 128)			10
128		7.5	7.5	
132		7.5	7.5	
134	(132, 136)			10
136		7.5	7.5	
140		7.5	7.5	
149		7.0	7.5	
151	(149, 153)			4.5
153		7.0	7.5	
157		7.5	8.0	
159	(157, 161)			5.0
161		8.0	9.0	
165		8.0	9.0	



### 10.3.3 Panel Antenna Models

The following are the panel antenna models for 5.2 GHz:

<b>Part Number</b>
ML-5299-WPNA1-01R
ML-2452-PNL9M3-036

#### 10.3.3.1 Panel Antenna Maximum Conducted Transmit Power Settings

The following is a transmit power table (US domain) per panel antenna in the 5 GHz band:

<b>20 MHZ CHANNEL</b>	<b>40 MHZ CHANNEL</b>	<b>LEGACY OFDM RATES (6,9,12,18,24,36,48,54 MBPS)</b>	<b>802.11n HT20 RATES (MCS 0 MCS 15)</b>	<b>802.11n HT40 RATES (MCS 0 MCS 15)</b>
36		4	4	
38	(36, 40)			6
40		4	4	
42		4	4	
44		4	4	
46	(44, 48)			6
48		4	4	
52		10	10	
54	(52, 56)			13
56		10	10	
60		10	10	
62	(60, 64)			11
64		10	10	
100		10	10	
102	(100, 104)			5
104		10	10	
108		10	10	
112		10	10	
110	(108, 112)			13
116		10	10	
118	(116, 120)			13
120		10	10	
124		10	10	
126	(124, 128)			12
128		10	10	
132		10	10	

<b>20 MHZ CHANNEL</b>	<b>40 MHZ CHANNEL</b>	<b>LEGACY OFDM RATES (6,9,12,18,24,36,48,54 MBPS)</b>	<b>802.11n HT20 RATES (MCS 0 MCS 15)</b>	<b>802.11n HT40 RATES (MCS 0 MCS 15)</b>
134	(132, 136)			12
136		10	10	
140		8	8	
149		8.0	9.0	
151	(149, 153)			6.0
153		8.0	9.0	
157		9.0	10.0	
159	(157, 161)			7.0
161		10	10	
165		10	10	

### 10.3.4 Embedded Antenna Models

The following is the embedded antenna model for 5.2 GHz:

<b>Part Number</b>
ML-2452-PTA2M3X3-1

#### 10.3.4.1 Embedded Antenna Maximum Conducted Transmit Power Settings

The following is a transmit power table (US domain) per embedded antenna in the 5 GHz band:

<b>20 MHZ CHANNEL</b>	<b>40 MHZ CHANNEL</b>	<b>LEGACY OFDM RATES (6,9,12,18,24,36,48,54 MBPS)</b>	<b>802.11n HT20 RATES (MCS 0 MCS 15)</b>	<b>802.11n HT40 RATES (MCS 0 MCS 15)</b>
36		11	11	
38	(36, 40)			12
40		11	11	
42		11	11	
44		11	11	
46	(44, 48)			13
48		11	11	
52		18	18	
54	(52, 56)			20
56		18	18	
60		18	18	
62	(60, 64)			14
64		18	18	
100		15	16	
102	(100, 104)			8
104		14	16	
108		14	16	
112		14	16	
110	(108, 112)			19
116		14	16	
118	(116, 120)			19
120		18	18	
124		18	13	
126	(124, 128)			19
128		14	13	

<b>20 MHZ CHANNEL</b>	<b>40 MHZ CHANNEL</b>	<b>LEGACY OFDM RATES (6,9,12,18,24,36,48,54 MBPS)</b>	<b>802.11n HT20 RATES (MCS 0 MCS 15)</b>	<b>802.11n HT40 RATES (MCS 0 MCS 15)</b>
132		14	13	
134	(132, 136)			14
136		13	13	
140		13	13	
149		18.0	18.0	
151	(149, 153)			15.0
153		18.0	18.0	
157		18.0	18.0	
159	(157, 161)			16.0
161		19.0	19.0	
165		19.0	19.0	

### 10.3.5 Dipole Antenna Models

The following are the dipole antenna models for 5.2 GHz:

<b>Part Number</b>
ML-5299HPA1-01R
ML-2452-APA6J-01
ML-2452-APA2-01

#### 10.3.5.1 Dipole Antenna Maximum Conducted Transmit Power Settings

The following is a transmit power table (US domain) per dipole antenna in the 5 GHz band:

<b>20 MHZ CHANNEL</b>	<b>40 MHZ CHANNEL</b>	<b>LEGACY OFDM RATES (6,9,12,18,24,36,48,54 MBPS)</b>	<b>802.11n HT20 RATES (MCS 0 MCS 15)</b>	<b>802.11n HT40 RATES (MCS 0 MCS 15)</b>
36		11	11	
38	(36, 40)			12
40		11	11	
42		11	11	
44		11	11	
46	(44, 48)			13
48		11	11	
52		18	18	
54	(52, 56)			20
56		18	18	
60		18	18	
62	(60, 64)			14
64		18	18	
100		15	14	
102	(100, 104)			7
104		15	14	
108		15	14	
112		15	14	
110	(108, 112)			19
116		15	14	
118	(116, 120)			19
120		18	18	
124		15	18	

<b>20 MHZ CHANNEL</b>	<b>40 MHZ CHANNEL</b>	<b>LEGACY OFDM RATES (6,9,12,18,24,36,48,54 MBPS)</b>	<b>802.11n HT20 RATES (MCS 0 MCS 15)</b>	<b>802.11n HT40 RATES (MCS 0 MCS 15)</b>
126	(124, 128)			19
128		15	18	
132		15	18	
134	(132, 136)			14
136		13	16	
140		13	16	
149		18.0	18.0	
151	(149, 153)			15.0
153		18.0	19.0	
157		18.0	19.0	
159	(157, 161)			16.0
161		19.0	19.0	
165		19.0	19.0	

### 10.3.6 Patch Antenna Models

The following is the patch antenna model for 5.2 GHz:

<b>Part Number</b>
ML-2452-PTA3M3-036

#### 10.3.6.1 Patch Antenna Maximum Conducted Transmit Power Settings

The following is a transmit power table (US domain) per patch antenna in the 5 GHz band:

<b>20 MHZ CHANNEL</b>	<b>40 MHZ CHANNEL</b>	<b>LEGACY OFDM RATES (6,9,12,18,24,36,48,54 MBPS)</b>	<b>802.11n HT20 RATES (MCS 0 MCS 15)</b>	<b>802.11n HT40 RATES (MCS 0 MCS 15)</b>
36		11	11	
38	(36, 40)			12
40		11	11	
42		11	11	
44		11	11	
46	(44, 48)			13
48		11	11	
52		18	18	
54	(52, 56)			20
56		18	18	
60		18	18	
62	(60, 64)			14
64		18	18	
100		15	16	
102	(100, 104)			8
104		18	16	
108		18	16	
112		18	18	
110	(108, 112)			13
116		18	18	
118	(116, 120)			19
120		18	18	
124		18	18	
126	(124, 128)			19
128		18	18	

<b>20 MHZ CHANNEL</b>	<b>40 MHZ CHANNEL</b>	<b>LEGACY OFDM RATES (6,9,12,18,24,36,48,54 MBPS)</b>	<b>802.11n HT20 RATES (MCS 0 MCS 15)</b>	<b>802.11n HT40 RATES (MCS 0 MCS 15)</b>
132		18	18	
134	(132, 136)			14
136		13	13	
140		13	13	
149		18.0	18.0	
151	(149, 153)			15.0
153		18.0	19.0	
157		18.0	19.0	
159	(157, 161)			16.0
161		19.0	19.0	
165		19.0	19.0	



## 10.4 Japan Regulatory Domain 2.4 GHz Band

### 10.4.1 Panel Antenna Model

The following is the panel antenna model for 2.4 GHz:

<b>Part Number</b>
ML-2499-11PNA2-01R

#### 10.4.1.1 Panel Antenna Maximum Conducted Transmit Power Settings

The following is a transmit power table (Japan domain) per panel antenna in the 2.4 GHz band:

<b>20 MHZ CHANNEL</b>	<b>40 MHZ CHANNEL</b>	<b>LEGACY DSSS RATES (1, 2, 5.5, 11 MBPS)</b>	<b>LEGACY OFDM RATES (6,9,12,18,24,36, 48,54 MBPS)</b>	<b>802.11n HT20 RATES (MCS 0 MCS 15)</b>	<b>802.11n HT40 RATES (MCS 0 MCS15)</b>
1		19.0	19.0	19.0	
2		19.0	19.0	19.0	
3	(1, 5)	19.0	19.0	19.0	16.0
4	(2, 6)	19.0	19.0	19.0	16.0
5	(3, 7)	19.0	19.0	19.0	16.0
6	(4, 8)	19.0	19.0	19.0	16.0
7	(5, 9)	19.0	19.0	19.0	16.0
8	(6, 10)	19.0	19.0	19.0	16.0
9	(7, 11)	19.0	19.0	19.0	16.0
10		19.0	19.0	19.0	
11		19.0	19.0	19.0	
12		19.0	19.0	19.0	
13		19.0	19.0	19.0	
14		19.0			

## 10.4.2 Embedded Antenna Model

The following is the embedded antenna model for 2.4 GHz:

<b>Part Number</b>
ML-2452-PTA2M3X3-1

### 10.4.2.1 Panel Antenna Maximum Conducted Transmit Power Settings

The following is a transmit power table (Japan domain) per embedded antenna in the 2.4 GHz band:

<b>20 MHZ CHANNEL</b>	<b>40 MHZ CHANNEL</b>	<b>LEGACY DSSS RATES (1, 2, 5.5, 11 MBPS)</b>	<b>LEGACY OFDM RATES (6,9,12,18,24,36, 48,54 MBPS)</b>	<b>802.11n HT20 RATES (MCS 0 MCS 15)</b>	<b>802.11n HT40 RATES (MCS 0 MCS15)</b>
1		11.0	11.0	11.0	
2		11.0	11.0	11.0	
3	(1, 5)	11.0	11.0	11.0	8.0
4	(2, 6)	11.0	11.0	11.0	8.0
5	(3, 7)	11.0	11.0	11.0	8.0
6	(4, 8)	11.0	11.0	11.0	8.0
7	(5, 9)	11.0	11.0	11.0	8.0
8	(6, 10)	11.0	11.0	11.0	8.0
9	(7, 11)	11.0	11.0	11.0	8.0
10		11.0	11.0	11.0	
11		11.0	11.0	11.0	
12		11.0	11.0	11.0	
13		11.0	11.0	11.0	
14		11.0			

### 10.4.3 Dipole Antenna Model

The following is the patch antenna model for 2.4 GHz:

<b>Part Number</b>
ML-2452-APA2-01
ML-2499-HPA3-01R
ML-2452-APA6J-01 (microcell)

#### 10.4.3.1 Dipole Antenna Maximum Conducted Transmit Power Settings

The following is a transmit power table (Japan domain) per dipole antenna in the 2.4 GHz band:

<b>20 MHZ CHANNEL</b>	<b>40 MHZ CHANNEL</b>	<b>LEGACY DSSS RATES (1, 2, 5.5, 11 MBPS)</b>	<b>LEGACY OFDM RATES (6,9,12,18,24,36, 48,54 MBPS)</b>	<b>802.11n HT20 RATES (MCS 0 MCS 15)</b>	<b>802.11n HT40 RATES (MCS 0 MCS15)</b>
1		14.0	14.0	14.0	
2		14.0	14.0	14.0	
3	(1, 5)	14.0	14.0	14.0	11
4	(2, 6)	14.0	14.0	14.0	11
5	(3, 7)	14.0	14.0	14.0	11
6	(4, 8)	14.0	14.0	14.0	11
7	(5, 9)	14.0	14.0	14.0	11
8	(6, 10)	14.0	14.0	14.0	11
9	(7, 11)	14.0	14.0	14.0	11
10		14.0	14.0	14.0	
11		14.0	14.0	14.0	
12		14.0	14.0	14.0	
13		14.0	14.0	14.0	
14		14.0			

### 10.4.4 Patch Antenna Model

The following is the patch antenna model for 2.4 GHz:

<b>Part Number</b>	<b>2.4 GHz Antenna Net Gain</b>
ML-2452-PTA3M3-036	3

#### 10.4.4.1 Patch Antenna Maximum Conducted Transmit Power Settings

The following is a transmit power table (Japan domain) per patch antenna in the 2.4 GHz band:

<b>20 MHZ CHANNEL</b>	<b>40 MHZ CHANNEL</b>	<b>LEGACY DSSS RATES (1, 2, 5.5, 11 MBPS)</b>	<b>LEGACY OFDM RATES (6,9,12,18,24,36, 48,54 MBPS)</b>	<b>802.11n HT20 RATES (MCS 0 MCS 15)</b>	<b>802.11n HT40 RATES (MCS0 MCS15)</b>
1		16.0	16.0	16.0	
2		16.0	16.0	16.0	
3	(1, 5)	16.0	16.0	16.0	10.0
4	(2, 6)	16.0	16.0	16.0	10.0
5	(3, 7)	16.0	16.0	16.0	10.0
6	(4, 8)	16.0	16.0	16.0	10.0
7	(5, 9)	16.0	16.0	16.0	10.0
8	(6, 10)	16.0	16.0	16.0	10.0
9	(7, 11)	16.0	16.0	16.0	10.0
10		16.0	16.0	16.0	
11		16.0	16.0	16.0	
12		16.0	16.0	16.0	
13		16.0	16.0	16.0	
14		16.0			

## 10.5 Japan Regulatory Domain 5.2 GHz Band

### 10.5.1 Panel Antenna Models

The following are the panel antenna models for 5.2 GHz:

<b>Part Number</b>
ML-5299-WPNA1-01R
ML-2452-PNL9M3-036

#### 10.5.1.1 Panel Antenna Maximum Conducted Transmit Power Settings

The following is a transmit power table (Japan domain) per panel antenna in the 5 GHz band:

<b>20 MHZ CHANNEL</b>	<b>40 MHZ CHANNEL</b>	<b>LEGACY OFDM RATES (6,9,12,18,24,36,48,54 MBPS)</b>	<b>802.11n HT20 RATES (MCS 0 MCS 15)</b>	<b>802.11n HT40 RATES (MCS 0 MCS 15)</b>
36		12.0	12.0	
38	(36, 40)			18.0
40		12.0	12.0	
42		12.0	12.0	
44		12.0	12.0	
46	(44, 48)			18.0
48		12.0	12.0	
52		12.0	12.0	
54	(52, 56)			18.0
56		12.0	12.0	
60		12.0	12.0	
62	(60, 64)			18.0
64		12.0	12.0	
100		19.0	19.0	
102	(100, 104)			18.0
104		19.0	19.0	
108		19.0	19.0	
112		19.0	19.0	
110	(108, 112)			18.0
116		19.0	19.0	
118	(116, 120)			18.0
120		19.0	19.0	
124		19.0	19.0	

<b>20 MHZ CHANNEL</b>	<b>40 MHZ CHANNEL</b>	<b>LEGACY OFDM RATES (6,9,12,18,24,36,48,54 MBPS)</b>	<b>802.11n HT20 RATES (MCS 0 MCS 15)</b>	<b>802.11n HT40 RATES (MCS 0 MCS 15)</b>
126	(124, 128)			18.0
128		19.0	19.0	
132		19.0	19.0	
134	(132, 136)			18.0
136		19.0	19.0	
140		19.0	19.0	
149				
151	(149, 153)			
153				
157				
159	(157, 161)			
161				
165				

## 10.5.2 Embedded Antenna Model

The following is the embedded antenna model for 5.2 GHz:

<b>Part Number</b>
ML-5299-WPNA1-01R

### 10.5.2.1 Embedded Antenna Maximum Conducted Transmit Power Settings

The following is a transmit power table (Japan domain) per embedded antenna in the 5 GHz band:

<b>20 MHZ CHANNEL</b>	<b>40 MHZ CHANNEL</b>	<b>LEGACY OFDM RATES (6,9,12,18,24,36,48,54 MBPS)</b>	<b>802.11n HT20 RATES (MCS 0 MCS 15)</b>	<b>802.11n HT40 RATES (MCS 0 MCS 15)</b>
36		10.0	10.0	
38	(36, 40)			7.0
40		10.0	10.0	
42		10.0	10.0	
44		10.0	10.0	
46	(44, 48)			7.0
48		10.0	10.0	
52		10.0	10.0	
54	(52, 56)			7.0
56		10.0	10.0	
60		10.0	10.0	
62	(60, 64)			7.0
64		10.0	10.0	
100		17.0	17.0	
102	(100, 104)			7.0
104		17.0	17.0	
108		17.0	17.0	
112		17.0	17.0	
110	(108, 112)			7.0
116		17.0	17.0	
118	(116, 120)			7.0
120		17.0	17.0	
124		17.0	17.0	
126	(124, 128)			7.0
128		17.0	17.0	

<b>20 MHZ CHANNEL</b>	<b>40 MHZ CHANNEL</b>	<b>LEGACY OFDM RATES (6,9,12,18,24,36,48,54 MBPS)</b>	<b>802.11n HT20 RATES (MCS 0 MCS 15)</b>	<b>802.11n HT40 RATES (MCS 0 MCS 15)</b>
132		17.0	17.0	
134	(132, 136)			7.0
136		17.0	17.0	
140		17.0	17.0	
149				
151	(149, 153)			
153				
157				
159	(157, 161)			
161				
165				



### 10.5.3 Dipole Antenna Models

The following are the dipole antenna models for 5.2 GHz:

<b>Part Number</b>
ML-5299-HPA1-01R
ML-2452-APA6J-01
ML-2452-APA2-01

#### 10.5.3.1 Dipole Antenna Maximum Conducted Transmit Power Settings

The following is a transmit power table (Japan domain) per dipole antenna in the 5 GHz band:

<b>20 MHZ CHANNEL</b>	<b>40 MHZ CHANNEL</b>	<b>LEGACY OFDM RATES (6,9,12,18,24,36,48,54 MBPS)</b>	<b>802.11n HT20 RATES (MCS 0 MCS 15)</b>	<b>802.11n HT40 RATES (MCS 0 MCS 15)</b>
36		12.0	12.0	
38	(36, 40)			9.0
40		12.0	12.0	
42		12.0	12.0	
44		12.0	12.0	
46	(44, 48)			9.0
48		12.0	12.0	
52		12.0	12.0	
54	(52, 56)			9.0
56		12.0	12.0	
60		12.0	12.0	
62	(60, 64)			9.0
64		12.0	12.0	
100		19.0	19.0	
102	(100, 104)			9.0
104		19.0	19.0	
108		19.0	19.0	
112		19.0	19.0	
110	(108, 112)			9.0
116		19.0	19.0	
118	(116, 120)			9.0
120		19.0	19.0	
124		19.0	19.0	
126	(124, 128)			9.0

<b>20 MHZ CHANNEL</b>	<b>40 MHZ CHANNEL</b>	<b>LEGACY OFDM RATES (6,9,12,18,24,36,48,54 MBPS)</b>	<b>802.11n HT20 RATES (MCS 0 MCS 15)</b>	<b>802.11n HT40 RATES (MCS 0 MCS 15)</b>
128		19.0	19.0	
132		19.0	19.0	
134	(132, 136)			9.0
136		19.0	19.0	
140		19.0	19.0	
149				
151	(149, 153)			
153				
157				
159	(157, 161)			
161				
165				

### 10.5.4 Patch Antenna Model

The following is the patch antenna model for 5.2 GHz:

<b>Part Number</b>
ML-2452-PTA3M3-036

#### 10.5.4.1 Patch Antenna Maximum Conducted Transmit Power Settings

The following is a transmit power table (Japan domain) per patch antenna in the 5 GHz band:

<b>20 MHZ CHANNEL</b>	<b>40 MHZ CHANNEL</b>	<b>LEGACY OFDM RATES (6,9,12,18,24,36,48,54 MBPS)</b>	<b>802.11n HT20 RATES (MCS 0 MCS 15)</b>	<b>802.11n HT40 RATES (MCS 0 MCS 15)</b>
36		21.0	21.0	
38	(36, 40)			10.0
40		21.0	21.0	
42		21.0	21.0	
44		21.0	21.0	
46	(44, 48)			10.0
48		21.0	21.0	
52		21.0	21.0	
54	(52, 56)			10.0
56		21.0	21.0	
60		21.0	21.0	
62	(60, 64)			10.0
64		21.0	21.0	
100		20.0	20.0	
102	(100, 104)			17.0
104		20.0	20.0	
108		20.0	20.0	
112		20.0	20.0	
110	(108, 112)			17.0
116		20.0	20.0	
118	(116, 120)			17.0
120		20.0	20.0	
124		20.0	20.0	
126	(124, 128)			17.0
128		20.0	20.0	

<b>20 MHZ CHANNEL</b>	<b>40 MHZ CHANNEL</b>	<b>LEGACY OFDM RATES (6,9,12,18,24,36,48,54 MBPS)</b>	<b>802.11n HT20 RATES (MCS 0 MCS 15)</b>	<b>802.11n HT40 RATES (MCS 0 MCS 15)</b>
132		20.0	20.0	
134	(132, 136)			17.0
136		20.0	20.0	
140		20.0	20.0	
149				
151	(149, 153)			
153				
157				
159	(157, 161)			
161				
165				

## AP650 Regulatory Domains

### 11.1 US Regulatory Domain 2.4 GHz Band

#### 11.1.1 Dipole Antenna Maximum Conducted Transmit Power Settings

The following is a transmit power table (US domain) per dipole antenna in the 2.4 GHz band:

<b>20 MHZ CHANNEL</b>	<b>40 MHZ CHANNEL</b>	<b>LEGACY DSSS RATES (1, 2, 5.5, 11 MBPS)</b>	<b>LEGACY OFDM RATES (6,9,12,18,24,36, 48,54 MBPS)</b>	<b>802.11n HT20 RATES (MCS 0 MCS 15)</b>	<b>802.11n HT40 RATES (MCS 0 MCS15)</b>
1		19.5	16.5	16.0	
2		19.0	16.5	16.0	
3	(1, 5)	19.0	20.0	20.0	13.5
4	(2, 6)	19.0	20.0	20.0	13.5
5	(3, 7)	19.0	20.0	20.0	15.5
6	(4, 8)	19.0	20.0	20.0	15.5
7	(5, 9)	19.0	20.0	20.0	15.5
8	(6, 10)	19.0	20.0	20.0	11.5
9	(7, 11)	19.0	20.0	20.0	11.5
10	(8, 12)	19.0	14.0	14.0	
11	(9, 13)	19.0	14.0	14.0	

Net peak gain = 3dBi -> 10dBi

### 11.1.2 Internal Dual Band Antenna Maximum Conducted Transmit Power Settings

The following is a transmit power table (US domain) per internal dual band antenna in the 2.4 GHz band:

<b>20 MHZ CHANNEL</b>	<b>40 MHZ CHANNEL</b>	<b>LEGACY DSSS RATES (1, 2, 5.5, 11 MBPS)</b>	<b>LEGACY OFDM RATES (6,9,12,18,24,36, 48,54 MBPS)</b>	<b>802.11n HT20 RATES (MCS 0 MCS 15)</b>	<b>802.11n HT40 RATES (MCS 0 MCS15)</b>
1		19.0	16.0	15.0	
2		19.0	16.0	15.0	
3	(1, 5)	21.0	16.0	15.0	12.5
4	(2, 6)	21.0	21.0	20.0	12.5
5	(3, 7)	21.0	21.0	20.0	12.5
6	(4, 8)	21.0	21.0	20.0	15.5
7	(5, 9)	21.0	21.0	20.0	11.5
8	(6, 10)	21.0	21.0	20.0	11.5
9	(7, 11)	21.0	16.0	15.0	11.5
10	(8, 12)	18.5	16.0	15.0	
11	(9, 13)	18.5	16.0	15.0	

Net peak gain = 2dBi

### 11.1.3 Indoor Patch Antenna Maximum Conducted Transmit Power Settings

The following is a transmit power table (US domain) per Indoor Patch antenna in the 2.4 GHz band:

<b>20 MHZ CHANNEL</b>	<b>40 MHZ CHANNEL</b>	<b>LEGACY DSSS RATES (1, 2, 5.5, 11 MBPS)</b>	<b>LEGACY OFDM RATES (6,9,12,18,24,36, 48,54 MBPS)</b>	<b>802.11n HT20 RATES (MCS 0 MCS 15)</b>	<b>802.11n HT40 RATES (MCS 0 MCS15)</b>
1		19.5	16.0	16.5	
2		19.5	16.0	16.5	
3	(1, 5)	17.5	18.0	16.5	11.5
4	(2, 6)	21.0	18.0	16.5	11.5
5	(3, 7)	21.0	18.0	16.5	16.5
6	(4, 8)	21.0	18.0	16.5	13.5
7	(5, 9)	21.0	18.0	16.5	16.5
8	(6, 10)	21.0	18.0	16.5	12.0
9	(7, 11)	21.0	18.0	16.5	12.0
10	(8, 12)	19.0	15.5	15.0	
11	(9, 13)	19.0	15.5	15.0	

Net peak gain = 7.5dBi

### 11.1.4 Outdoor Omni Antenna Maximum Conducted Transmit Power Settings

The following is a transmit power table (US domain) per outdoor omni antenna in the 2.4 GHz band:

<b>20 MHZ CHANNEL</b>	<b>40 MHZ CHANNEL</b>	<b>LEGACY DSSS RATES (1, 2, 5.5, 11 MBPS)</b>	<b>LEGACY OFDM RATES (6,9,12,18,24,36, 48,54 MBPS)</b>	<b>802.11n HT20 RATES (MCS 0 MCS 15)</b>	<b>802.11n HT40 RATES (MCS0 MCS15)</b>
1		19.0	13.5	14.0	
2		19.0	13.5	14.0	
3	(1, 5)	19.0	13.5	14.0	10.5
4	(2, 6)	21.0	19.0	19.0	10.5
5	(3, 7)	21.0	19.0	19.0	10.5
6	(4, 8)	21.0	19.0	19.0	14.0
7	(5, 9)	21.0	19.0	19.0	9.5
8	(6, 10)	21.0	19.0	19.0	9.5
9	(7, 11)	19.5	14.0	13.0	9.5
10	(8, 12)	19.5	14.0	13.0	
11	(9, 13)	19.5	14.0	13.0	

Net peak gain = 3.3dBi



### 11.1.5 Panel Antenna Maximum Conducted Transmit Power Settings

The following is a transmit power table (US domain) per panel antenna in the 2.4 GHz band:

<b>20 MHZ CHANNEL</b>	<b>40 MHZ CHANNEL</b>	<b>LEGACY DSSS RATES (1, 2, 5.5, 11 MBPS)</b>	<b>LEGACY OFDM RATES (6,9,12,18,24,36, 48,54 MBPS)</b>	<b>802.11n HT20 RATES (MCS 0 MCS 15)</b>	<b>802.11n HT40 RATES (MCS0 MCS15)</b>
1		14.5	13.5	12.0	
2		14.5	13.5	12.0	
3	(1, 5)	14.5	15.0	15.0	8.5
4	(2, 6)	14.5	15.0	15.0	8.5
5	(3, 7)	14.5	15.0	15.0	12.0
6	(4, 8)	14.5	15.0	15.0	12.0
7	(5, 9)	14.5	15.0	15.0	12.0
8	(6, 10)	14.5	15.0	15.0	8.5
9	(7, 11)	14.5	15.0	15.0	8.5
10	(8, 12)	14.0	12.0	11.0	
11	(9, 13)	14.0	12.0	11.0	

Net peak gain = 15.5dBi

## 11.2 US Regulatory Domain 5 GHz Band

### 11.2.1 Dual Band Dipole Antenna Maximum Conducted Transmit Power Settings

The following is a transmit power table (US domain) per dual band dipole antenna in the 5 GHz band:

<b>20 MHZ CHANNEL</b>	<b>40 MHZ CHANNEL</b>	<b>LEGACY OFDM RATES (6,9,12,18,24,36,48,54 MBPS)</b>	<b>802.11n HT20 RATES (MCS 0 MCS 15)</b>	<b>802.11n HT40 RATES (MCS 0 MCS 15)</b>
36		11.0	11.0	
38	(36, 40)	11.0	11.0	11.0
40		11.0	11.0	
42		11.0	11.0	
44		11.0	11.0	
46	(44, 48)	11.0	11.0	11.0
48		11.0	11.0	
52		17.0	17.0	
54	(52, 56)	17.0	17.0	16.5
56		17.0	17.0	
60		17.0	17.0	
62	(60, 64)	17.0	17.0	11.0
64		15.0	15.0	
100		12.0	15.0	
102	(100, 104)	17.0	17.0	10.0
104		17.0	17.0	
108		17.0	17.0	
112		17.0	17.0	
110	(108, 112)	17.0	17.0	17.5
116		17.0	17.0	
118	(116, 120)	17.0	17.0	14.0
120		17.0	17.0	
124		17.0	17.0	
126	(124, 128)	17.0	17.0	17.5
128		17.0	17.0	
132		17.0	17.0	
134	(132, 136)	17.0	17.0	14.0
136		17.0	17.0	
140		12.0	12.0	

<b>20 MHZ CHANNEL</b>	<b>40 MHZ CHANNEL</b>	<b>LEGACY OFDM RATES (6,9,12,18,24,36,48,54 MBPS)</b>	<b>802.11n HT20 RATES (MCS 0 MCS 15)</b>	<b>802.11n HT40 RATES (MCS 0 MCS 15)</b>
149		19.0	19.0	
151	(149, 153)	19.0	19.0	18.0
153		19.0	19.0	
157		19.0	19.0	
159	(157, 161)	19.0	19.0	18.0
161		19.0	19.0	
165		19.0	19.0	

Net peak gain = 5dBi

## 11.2.2 Internal Dual Band Antenna Maximum Conducted Transmit Power Settings

The following is a transmit power table (US domain) per internal dual band antenna in the 5 GHz band:

<b>20 MHZ CHANNEL</b>	<b>40 MHZ CHANNEL</b>	<b>LEGACY OFDM RATES (6,9,12,18,24,36,48,54 MBPS)</b>	<b>802.11n HT20 RATES (MCS 0 MCS 15)</b>	<b>802.11n HT40 RATES (MCS 0 MCS 15)</b>
36		11.0	11.0	
38	(36,40)	11.0	11.0	11.0
40		11.0	11.0	
42		11.0	11.0	
44		11.0	11.0	
46	(44,48)	11.0	11.0	12.5
48		11.0	11.0	
52		17.5	17.5	
54	(52,56)	17.5	17.5	18.0
56		17.5	17.5	
60		17.5	17.5	
62	(60,64)	17.5	17.5	14.0
64		14.5	14.5	
100		17.0	17.0	
102	(100,104)	17.0	17.0	15.0
104		17.0	17.0	
108		17.0	17.0	
112		17.0	17.0	
110	(108,112)	17.0	17.0	18.0
116		17.0	17.0	
118	(116,120)	17.0	17.0	18.0
120		17.0	17.0	
124		17.0	17.0	
126	(124,128)	17.0	17.0	18.0
128		17.0	17.0	
132		17.0	17.0	
134	(132,136)	17.0	17.0	17.5
136		17.0	17.0	
140		15.5	15.5	
149		19.0	19.0	
151	(149,153)	19.0	19.0	18.0
153		19.0	19.0	

<b>20 MHZ CHANNEL</b>	<b>40 MHZ CHANNEL</b>	<b>LEGACY OFDM RATES (6,9,12,18,24,36,48,54 MBPS)</b>	<b>802.11n HT20 RATES (MCS 0 MCS 15)</b>	<b>802.11n HT40 RATES (MCS 0 MCS 15)</b>
157		19.0	19.0	
159	(157,161)	19.0	19.0	18.0
161		19.0	19.0	
165		19.0	19.0	

Net peak gain = 3.4dBi

### 11.2.3 Indoor Patch Antenna Maximum Conducted Transmit Power Settings

The following is a transmit power table (US domain) per indoor patch antenna in the 5 GHz band:

<b>20 MHZ CHANNEL</b>	<b>40 MHZ CHANNEL</b>	<b>LEGACY OFDM RATES (6,9,12,18,24,36,48,54 MBPS)</b>	<b>802.11n HT20 RATES (MCS 0 MCS 15)</b>	<b>802.11n HT40 RATES (MCS 0 MCS 15)</b>
36		9.5	9.5	
38	(36, 40)	10.0	10.0	10.0
40		10.0	10.0	
42		10.0	10.0	
44		10.0	10.0	
46	(44, 48)	10.0	10.0	11.0
48		10.0	10.5	
52		17.5	17.5	
54	(52, 56)	17.5	17.5	17.0
56		17.5	17.5	
60		17.5	17.5	
62	(60, 64)	17.5	17.5	10.5
64		15.0	15.0	
100		12.5	12.5	
102	(100, 104)	17.0	17.5	8.0
104		17.0	17.5	
108		17.0	17.5	
112		17.0	17.5	
110	(108, 112)	17.0	17.5	16.0
116		17.0	17.5	
118	(116, 120)	17.0	17.5	16.0
120		17.0	17.5	
124		17.0	17.5	
126	(124, 128)	17.0	17.5	16.0
128		17.0	17.5	
132		17.0	17.5	
134	(132, 136)	17.0	17.5	13.0
136		17.0	17.5	
140		14.0	14.0	
149		19.0	19.0	

<b>20 MHZ CHANNEL</b>	<b>40 MHZ CHANNEL</b>	<b>LEGACY OFDM RATES (6,9,12,18,24,36,48,54 MBPS)</b>	<b>802.11n HT20 RATES (MCS 0 MCS 15)</b>	<b>802.11n HT40 RATES (MCS 0 MCS 15)</b>
151	(149, 153)	19.0	19.0	18.0
153		19.0	19.0	
157		19.0	19.0	
159	(157, 161)	19.0	19.0	18.0
161		19.0	19.0	
165		19.0	19.0	

Net peak gain = 7dBi

## 11.2.4 Outdoor Omni Antenna Transmit Power Settings

The following is a transmit power table (US domain) per outdoor omni antenna in the 5 GHz band:

<b>20 MHZ CHANNEL</b>	<b>40 MHZ CHANNEL</b>	<b>LEGACY OFDM RATES (6,9,12,18,24,36,48,54 MBPS)</b>	<b>802.11n HT20 RATES (MCS 0 MCS 15)</b>	<b>802.11n HT40 RATES (MCS 0 MCS 15)</b>
36		10.0	10.0	
38	(36, 40)	10.0	10.0	10.0
40		10.0	10.0	
42		10.0	10.0	
44		10.0	10.0	
46	(44, 48)	10.0	10.0	10.0
48		10.0	10.0	
52		16.5	16.0	
54	(52, 56)	16.5	16.0	16.0
56		16.5	16.0	
60		16.0	16.0	
62	(60, 64)	15.0	16.0	14.0
64		15.0	16.0	
100		15.0	16.0	
102	(100, 104)	15.0	11.0	11.0
104		15.0	15.0	
108		15.0	15.0	
112		15.0	15.0	
110	(108, 112)	15.0	15.0	15.0
116		15.0	15.0	
118	(116, 120)	15.0	15.0	15.0
120		15.0	15.0	
124		15.0	15.0	
126	(124, 128)	15.0	15.0	5.0
128		15.0	15.0	
132		15.0	15.0	
134	(132, 136)	15.0	15.0	5.0
136		15.0	15.0	
140		12.0	12.0	
149		19.0	19.0	



<b>20 MHZ CHANNEL</b>	<b>40 MHZ CHANNEL</b>	<b>LEGACY OFDM RATES (6,9,12,18,24,36,48,54 MBPS)</b>	<b>802.11n HT20 RATES (MCS 0 MCS 15)</b>	<b>802.11n HT40 RATES (MCS 0 MCS 15)</b>
151	(149, 153)	19.0	19.0	19.0
153		19.0	19.0	
157		19.0	19.0	
159	(157, 161)	19.0	19.0	19.0
161		19.0	19.0	
165		19.0	19.0	

Net peak gain = 10.5dBi

## 11.2.5 Panel Antenna Maximum Conducted Transmit Power Settings

The following is a transmit power table (US domain) per panel antenna in the 5 GHz band:

<b>20 MHZ CHANNEL</b>	<b>40 MHZ CHANNEL</b>	<b>LEGACY OFDM RATES (6,9,12,18,24,36,48,54 MBPS)</b>	<b>802.11n HT20 RATES (MCS 0 MCS 15)</b>	<b>802.11n HT40 RATES (MCS 0 MCS 15)</b>
36		5.5	5.5	
38	(36, 40)	5.5	5.5	5.0
40		5.5	5.5	
42		5.5	5.5	
44		5.5	5.5	
46	(44, 48)	5.5	5.5	5.0
48		5.5	5.5	
52		12.0	12.0	
54	(52, 56)	12.0	12.0	12.0
56		12.0	12.0	
60		12.0	12.0	
62	(60, 64)	11.5	11.5	4.0
64		10.5	10.5	
100		11.0	11.0	
102	(100, 104)	11.0	11.0	3.0
104		11.0	11.0	
108		11.0	11.0	
112		11.0	11.0	
110	(108, 112)	11.0	11.0	11.0
116		11.0	11.0	
118	(116, 120)	11.0	11.0	11.5
120		11.0	11.0	
124		11.0	11.0	
126	(124, 128)	11.0	11.0	17.5
128		11.0	11.0	
132		11.0	11.0	
134	(132, 136)	11.0	11.0	17.5
136		9.5	9.5	
140		9.5	9.5	
149		17.5	17.5	

<b>20 MHZ CHANNEL</b>	<b>40 MHZ CHANNEL</b>	<b>LEGACY OFDM RATES (6,9,12,18,24,36,48,54 MBPS)</b>	<b>802.11n HT20 RATES (MCS 0 MCS 15)</b>	<b>802.11n HT40 RATES (MCS 0 MCS 15)</b>
151	(149, 153)	17.5	17.5	16.5
153		17.5	17.5	
157		17.5	17.5	
159	(157, 161)	17.5	17.5	16.5
161		17.5	17.5	
165		17.5	17.5	

Net peak gain = 14dBi

## 11.2.6 Yagi Antenna Model

The following is a transmit power table (US domain) per yagi antenna in the 5 GHz band:

<b>20 MHZ CHANNEL</b>	<b>40 MHZ CHANNEL</b>	<b>LEGACY OFDM RATES (6,9,12,18,24,36,48,54 MBPS)</b>	<b>802.11n HT20 RATES (MCS 0 MCS 15)</b>	<b>802.11n HT40 RATES (MCS 0 MCS 15)</b>
36		11.5	5.5	
38	(36, 40)	11.5	11.5	11.5
40		11.5	11.5	
42		11.5	11.5	
44		11.5	11.5	
46	(44, 48)	11.5	11.5	11.5
48		11.5	11.5	
52		16.0	16.0	
54	(52, 56)	16.0	16.0	16.0
56		16.0	16.0	
60		16.0	16.0	
62	(60, 64)	16.0	16.0	16.0
64		16.0	16.0	
100		16.0	16.0	
102	(100, 104)	16.0	16.0	11.0
104		16.0	16.0	
108		16.0	16.0	
112		16.0	16.0	
110	(108, 112)	16.0	16.0	16.0
116		16.0	16.0	
118	(116, 120)	16.0	16.0	16.0
120		16.0	16.0	
124		16.0	16.0	
126	(124, 128)	16.0	16.0	16.0
128		16.0	16.0	
132		16.0	16.0	
134	(132, 136)	16.0	16.0	13.0
136		16.0	16.0	
140		14.0	14.0	
149		18.0	18.0	

<b>20 MHZ CHANNEL</b>	<b>40 MHZ CHANNEL</b>	<b>LEGACY OFDM RATES (6,9,12,18,24,36,48,54 MBPS)</b>	<b>802.11n HT20 RATES (MCS 0 MCS 15)</b>	<b>802.11n HT40 RATES (MCS 0 MCS 15)</b>
151	(149, 153)	18.0	18.0	18.0
153		18.0	18.0	
157		18.0	18.0	
159	(157, 161)	18.0	18.0	18.0
161		18.0	18.0	
165		18.0	18.0	

Net peak gain = 10.5dBi

## 11.3 Japan Regulatory Domain 2.4 GHz Band

### 11.3.1 Dipole Dual Band Antenna Maximum Conducted Transmit Power Settings

The following is a transmit power table (Japan domain) per dipole antenna in the 2.4 GHz band:

<b>20 MHZ CHANNEL</b>	<b>40 MHZ CHANNEL</b>	<b>LEGACY DSSS RATES (1, 2, 5.5, 11 MBPS)</b>	<b>LEGACY OFDM RATES (6,9,12,18,24,36, 48,54 MBPS)</b>	<b>802.11n HT20 RATES (MCS 0 MCS 15)</b>	<b>802.11n HT40 RATES (MCS 0 MCS15)</b>
1		14.5	14.5	16.0	
2		14.5	14.5	15.5	
3	(1, 5)	14.5	14.5	15.5	18.5
4	(2, 6)	14.5	14.5	15.5	18.5
5	(3, 7)	14.5	14.5	15.5	18.5
6	(4, 8)	14.5	14.5	15.5	18.5
7	(5, 9)	14.5	14.5	15.5	18.5
8	(6, 10)	14.5	14.5	15.5	18.5
9	(7, 11)	14.5	14.5	15.5	18.5
10		14.5	14.5	15.5	18.5
11		14.5	14.5	15.5	18.5
12		14.5	14.5	15.5	
13		14.5	14.5	15.5	
14		14.5			

Net peak gain = 7dBi

### 11.3.2 Internal Dual Band Antenna Maximum Conducted Transmit Power Settings

The following is a transmit power table (Japan domain) per internal dual band antenna in the 2.4 GHz band:

<b>20 MHZ CHANNEL</b>	<b>40 MHZ CHANNEL</b>	<b>LEGACY DSSS RATES (1, 2, 5.5, 11 MBPS)</b>	<b>LEGACY OFDM RATES (6,9,12,18,24,36, 48,54 MBPS)</b>	<b>802.11n HT20 RATES (MCS 0 MCS 15)</b>	<b>802.11n HT40 RATES (MCS 0 MCS15)</b>
1		19.5	19.5	19.5	
2		19.5	19.5	19.5	
3	(1, 5)	19.5	19.5	19.5	19.5
4	(2, 6)	19.5	19.5	19.5	19.5
5	(3, 7)	19.5	19.5	19.5	19.5
6	(4, 8)	19.5	19.5	19.5	19.5
7	(5, 9)	19.5	19.5	19.5	19.5
8	(6, 10)	19.5	19.5	19.5	19.5
9	(7, 11)	19.5	19.5	19.5	19.5
10		19.5	19.5	19.5	19.5
11		19.5	19.5	19.5	19.5
12		19.5	19.5	19.5	19.5
13		19.5	19.5	19.5	
14		19.5			

Net peak gain = 2dBi

### 11.3.3 Indoor Patch Antenna Maximum Conducted Transmit Power Settings

The following is a transmit power table (Japan domain) per Indoor Patch antenna in the 2.4 GHz band:

<b>20 MHZ CHANNEL</b>	<b>40 MHZ CHANNEL</b>	<b>LEGACY DSSS RATES (1, 2, 5.5, 11 MBPS)</b>	<b>LEGACY OFDM RATES (6,9,12,18,24,36, 48,54 MBPS)</b>	<b>802.11n HT20 RATES (MCS 0 MCS 15)</b>	<b>802.11n HT40 RATES (MCS 0 MCS15)</b>
1		18.0	18.0	18.0	
2		18.0	18.0	18.0	
3	(1, 5)	18.0	18.0	18.0	18.0
4	(2, 6)	18.0	18.0	18.0	18.0
5	(3, 7)	18.0	18.0	18.0	18.0
6	(4, 8)	18.0	18.0	18.0	18.0
7	(5, 9)	18.0	18.0	18.0	18.0
8	(6, 10)	18.0	18.0	18.0	18.0
9	(7, 11)	18.0	18.0	18.0	18.0
10		18.0	18.0	18.0	18.0
11		18.0	18.0	18.0	18.0
12		18.0	18.0	18.0	
13		18.0	18.0	18.0	
14		18.0			

Net peak gain = 3.5dBi



### 11.3.4 Outdoor Omni Antenna Maximum Conducted Transmit Power Settings

The following is a transmit power table (Japan domain) per outdoor omni antenna in the 2.4 GHz band:

<b>20 MHZ CHANNEL</b>	<b>40 MHZ CHANNEL</b>	<b>LEGACY DSSS RATES (1, 2, 5.5, 11 MBPS)</b>	<b>LEGACY OFDM RATES (6,9,12,18,24,36, 48,54 MBPS)</b>	<b>802.11n HT20 RATES (MCS 0 MCS 15)</b>	<b>802.11n HT40 RATES (MCS0 MCS15)</b>
1		18.0	18.0	18.0	
2		18.0	18.0	18.0	
3	(1, 5)	18.0	18.0	18.0	18.0
4	(2, 6)	18.0	18.0	18.0	18.0
5	(3, 7)	18.0	18.0	18.0	18.0
6	(4, 8)	18.0	18.0	18.0	18.0
7	(5, 9)	18.0	18.0	18.0	18.0
8	(6, 10)	18.0	18.0	18.0	18.0
9	(7, 11)	18.0	18.0	18.0	18.0
10		18.0	18.0	18.0	18.0
11		18.0	18.0	18.0	18.0
12		18.0	18.0	18.0	
13		18.0	18.0	18.0	
14		18.0			

Net peak gain = 3.3dBi

### 11.3.5 Panel Antenna Maximum Conducted Transmit Power Settings

The following is a transmit power table (Japan domain) per panel antenna in the 2.4 GHz band:

<b>20 MHZ CHANNEL</b>	<b>40 MHZ CHANNEL</b>	<b>LEGACY DSSS RATES (1, 2, 5.5, 11 MBPS)</b>	<b>LEGACY OFDM RATES (6,9,12,18,24,36, 48,54 MBPS)</b>	<b>802.11n HT20 RATES (MCS 0 MCS 15)</b>	<b>802.11n HT40 RATES (MCS0 MCS15)</b>
1		17.0	17.0	17.0	
2		17.0	17.0	17.0	
3	(1, 5)	17.0	17.0	17.0	17.0
4	(2, 6)	17.0	17.0	17.0	17.0
5	(3, 7)	17.0	17.0	17.0	17.0
6	(4, 8)	17.0	17.0	17.0	17.0
7	(5, 9)	17.0	17.0	17.0	17.0
8	(6, 10)	17.0	17.0	17.0	17.0
9	(7, 11)	17.0	17.0	17.0	17.0
10		17.0	17.0	17.0	17.0
11		17.0	17.0	17.0	17.0
12		17.0	17.0	17.0	
13		17.0	17.0	17.0	
14		17.0			

Net peak gain = 4.5dBi

### 11.3.6 Patch Antenna Maximum Conducted Transmit Power Settings

The following is a transmit power table (Japan domain) per patch antenna in the 2.4 GHz band:

<b>20 MHZ CHANNEL</b>	<b>40 MHZ CHANNEL</b>	<b>LEGACY DSSS RATES (1, 2, 5.5, 11 MBPS)</b>	<b>LEGACY OFDM RATES (6,9,12,18,24,36, 48,54 MBPS)</b>	<b>802.11n HT20 RATES (MCS 0 MCS 15)</b>	<b>802.11n HT40 RATES (MCS0 MCS15)</b>
1		17.0	17.0	17.0	
2		17.0	17.0	17.0	
3	(1, 5)	17.0	17.0	17.0	17.0
4	(2, 6)	17.0	17.0	17.0	17.0
5	(3, 7)	17.0	17.0	17.0	17.0
6	(4, 8)	17.0	17.0	17.0	17.0
7	(5, 9)	17.0	17.0	17.0	17.0
8	(6, 10)	17.0	17.0	17.0	17.0
9	(7, 11)	17.0	17.0	17.0	17.0
10		17.0	17.0	17.0	17.0
11		17.0	17.0	17.0	17.0
12		17.0	17.0	17.0	
13		17.0	17.0	17.0	
14		17.0			

Net peak gain = 4dBi

## 11.4 Japan Regulatory Domain 5 GHz Band

### 11.4.1 Dual Band Dipole Antenna Maximum Conducted Transmit Power Settings

The following is a transmit power table (Japan domain) per dual band dipole antenna in the 5 GHz band:

<b>20 MHZ CHANNEL</b>	<b>40 MHZ CHANNEL</b>	<b>LEGACY OFDM RATES (6,9,12,18,24,36,48,54 MBPS)</b>	<b>802.11n HT20 RATES (MCS 0 MCS 15)</b>	<b>802.11n HT40 RATES (MCS 0 MCS 15)</b>
36		13.0	13.0	
38	(36, 40)	13.0	13.0	13.0
40		13.0	13.0	
42		13.0	13.0	
44		13.0	13.0	
46	(44, 48)	13.0	13.0	13.0
48		13.0	13.0	
52		13.0	13.0	
54	(52, 56)	13.0	13.0	13.0
56		13.0	13.0	
60		13.0	13.0	
62	(60, 64)	13.0	13.0	13.0
64		13.0	13.0	
100		19.0	19.0	
102	(100, 104)	19.0	19.0	19.0
104		19.0	19.0	
108		19.0	19.0	
112		19.0	19.0	
110	(108, 112)	19.0	19.0	19.0
116		19.0	19.0	
118	(116, 120)	19.0	19.0	19.0
120		19.0	19.0	
124		19.0	19.0	
126	(124, 128)	19.0	19.0	19.0
128		19.0	19.0	
132		19.0	19.0	
134	(132, 136)	19.0	19.0	19.0
136		19.0	19.0	
140		19.0	19.0	

<b>20 MHZ CHANNEL</b>	<b>40 MHZ CHANNEL</b>	<b>LEGACY OFDM RATES (6,9,12,18,24,36,48,54 MBPS)</b>	<b>802.11n HT20 RATES (MCS 0 MCS 15)</b>	<b>802.11n HT40 RATES (MCS 0 MCS 15)</b>
149				
151	(149, 153)			
153				
157				
159	(157, 161)			
161				
165				

Net peak gain = 7dBi

### 11.4.2 Internal Dual Band Antenna Maximum Conducted Transmit Power Settings

The following is a transmit power table (Japan domain) per internal dual band antenna in the 5 GHz band:

<b>20 MHZ CHANNEL</b>	<b>40 MHZ CHANNEL</b>	<b>LEGACY OFDM RATES (6,9,12,18,24,36,48,54 MBPS)</b>	<b>802.11n HT20 RATES (MCS 0 MCS 15)</b>	<b>802.11n HT40 RATES (MCS 0 MCS 15)</b>
36		14.0	14.0	
38	(36,40)	14.0	14.0	14.0
40		14.0	14.0	
42		14.0	14.0	
44		14.0	14.0	
46	(44,48)	14.0	14.0	14.0
48		14.0	14.0	
52		14.0	14.0	
54	(52,56)	14.0	14.0	14.0
56		14.0	14.0	
60		14.0	14.0	
62	(60,64)	14.0	14.0	14.0
64		14.0	14.0	
100		19.0	19.0	
102	(100,104)	19.0	19.0	19.0
104		19.0	19.0	
108		19.0	19.0	
112		19.0	19.0	
110	(108,112)	19.0	19.0	19.0
116		19.0	19.0	
118	(116,120)	19.0	19.0	19.0
120		19.0	19.0	
124		19.0	19.0	
126	(124,128)	19.0	19.0	19.0
128		19.0	19.0	
132		19.0	19.0	
134	(132,136)	19.0	19.0	19.0
136		19.0	19.0	
140		19.0	19.0	
149				

<b>20 MHZ CHANNEL</b>	<b>40 MHZ CHANNEL</b>	<b>LEGACY OFDM RATES (6,9,12,18,24,36,48,54 MBPS)</b>	<b>802.11n HT20 RATES (MCS 0 MCS 15)</b>	<b>802.11n HT40 RATES (MCS 0 MCS 15)</b>
151	(149,153)			
153				
157				
159	(157,161)			
161				
165				

Net peak gain = 3.4dBi

### 11.4.3 Indoor Patch Antenna Maximum Conducted Transmit Power Settings

The following is a transmit power table (Japan domain) per indoor patch antenna in the 5 GHz band:

<b>20 MHZ CHANNEL</b>	<b>40 MHZ CHANNEL</b>	<b>LEGACY OFDM RATES (6,9,12,18,24,36,48,54 MBPS)</b>	<b>802.11n HT20 RATES (MCS 0 MCS 15)</b>	<b>802.11n HT40 RATES (MCS 0 MCS 15)</b>
36		14.5	14.5	
38	(36, 40)	14.5	14.5	14.5
40		14.5	14.5	
42		14.5	14.5	
44		14.5	14.5	
46	(44, 48)	14.5	14.5	14.5
48		14.5	14.5	
52		14.5	14.5	
54	(52, 56)	14.5	14.5	14.5
56		14.5	14.5	
60		14.5	14.5	
62	(60, 64)	14.5	14.5	14.5
64		14.5	14.5	
100		19.0	19.0	
102	(100, 104)	19.0	19.0	19.0
104		19.0	19.0	
108		19.0	19.0	
112		19.0	19.0	
110	(108, 112)	19.0	19.0	19.0
116		19.0	19.0	
118	(116, 120)	19.0	19.0	19.0
120		19.0	19.0	
124		19.0	19.0	
126	(124, 128)	19.0	19.0	19.0
128		19.0	19.0	
132		19.0	19.0	
134	(132, 136)	19.0	19.0	19.0
136		19.0	19.0	
140		19.0	19.0	
149				



<b>20 MHZ CHANNEL</b>	<b>40 MHZ CHANNEL</b>	<b>LEGACY OFDM RATES (6,9,12,18,24,36,48,54 MBPS)</b>	<b>802.11n HT20 RATES (MCS 0 MCS 15)</b>	<b>802.11n HT40 RATES (MCS 0 MCS 15)</b>
151	(149, 153)			
153				
157				
159	(157, 161)			
161				
165				

Net peak gain = 3dBi

### 11.4.4 Outdoor Omni Antenna Transmit Power Settings

The following is a transmit power table (Japan domain) per outdoor omni antenna in the 5 GHz band:

<b>20 MHZ CHANNEL</b>	<b>40 MHZ CHANNEL</b>	<b>LEGACY OFDM RATES (6,9,12,18,24,36,48,54 MBPS)</b>	<b>802.11n HT20 RATES (MCS 0 MCS 15)</b>	<b>802.11n HT40 RATES (MCS 0 MCS 15)</b>
36		18.0	18.0	
38	(36, 40)	18.0	18.0	18.0
40		18.0	18.0	
42		18.0	18.0	
44		18.0	18.0	
46	(44, 48)	18.0	18.0	18.0
48		18.0	18.0	
52		18.0	18.0	
54	(52, 56)	18.0	18.0	18.0
56		18.0	18.0	
60		18.0	18.0	
62	(60, 64)	18.0	18.0	18.0
64		18.0	18.0	
100		19.0	19.0	
102	(100, 104)	19.0	19.0	19.0
104		19.0	19.0	
108		19.0	19.0	
112		19.0	19.0	
110	(108, 112)	19.0	19.0	19.0
116		19.0	19.0	
118	(116, 120)	19.0	19.0	19.0
120		19.0	19.0	
124		19.0	19.0	
126	(124, 128)	19.0	19.0	19.0
128		19.0	19.0	
132		19.0	19.0	
134	(132, 136)	19.0	19.0	19.0
136		19.0	19.0	
140		19.0	19.0	
149				

<b>20 MHZ CHANNEL</b>	<b>40 MHZ CHANNEL</b>	<b>LEGACY OFDM RATES (6,9,12,18,24,36,48,54 MBPS)</b>	<b>802.11n HT20 RATES (MCS 0 MCS 15)</b>	<b>802.11n HT40 RATES (MCS 0 MCS 15)</b>
151	(149, 153)			
153				
157				
159	(157, 161)			
161				
165				

Net peak gain = 4.2dBi

### 11.4.5 Panel Antenna Maximum Conducted Transmit Power Settings

The following is a transmit power table (Japan domain) per panel antenna in the 5 GHz band:

<b>20 MHZ CHANNEL</b>	<b>40 MHZ CHANNEL</b>	<b>LEGACY OFDM RATES (6,9,12,18,24,36,48,54 MBPS)</b>	<b>802.11n HT20 RATES (MCS 0 MCS 15)</b>	<b>802.11n HT40 RATES (MCS 0 MCS 15)</b>
36		18.0	18.0	
38	(36, 40)	18.0	18.0	18.0
40		18.0	18.0	
42		18.0	18.0	
44		18.0	18.0	
46	(44, 48)	18.0	18.0	18.0
48		18.0	18.0	
52		18.0	18.0	
54	(52, 56)	18.0	18.0	18.0
56		18.0	18.0	
60		18.0	18.0	
62	(60, 64)	18.0	18.0	18.0
64		18.0	18.0	
100		19.0	19.0	
102	(100, 104)	19.0	19.0	19.0
104		19.0	19.0	
108		19.0	19.0	
112		19.0	19.0	
110	(108, 112)	19.0	19.0	19.0
116		19.0	19.0	
118	(116, 120)	19.0	19.0	19.0
120		19.0	19.0	
124		19.0	19.0	
126	(124, 128)	19.0	19.0	19.0
128		19.0	19.0	
132		19.0	19.0	
134	(132, 136)	19.0	19.0	19.0
136		19.0	19.0	
140		19.0	19.0	
149				

<b>20 MHZ CHANNEL</b>	<b>40 MHZ CHANNEL</b>	<b>LEGACY OFDM RATES (6,9,12,18,24,36,48,54 MBPS)</b>	<b>802.11n HT20 RATES (MCS 0 MCS 15)</b>	<b>802.11n HT40 RATES (MCS 0 MCS 15)</b>
151	(149, 153)			
153				
157				
159	(157, 161)			
161				
165				

Net peak gain = 5dBi

### 11.4.6 Patch Antenna Maximum Conducted Transmit Power Settings

The following is a transmit power table (Japan domain) per patch antenna in the 5 GHz band:

<b>20 MHZ CHANNEL</b>	<b>40 MHZ CHANNEL</b>	<b>LEGACY OFDM RATES (6,9,12,18,24,36,48,54 MBPS)</b>	<b>802.11n HT20 RATES (MCS 0 MCS 15)</b>	<b>802.11n HT40 RATES (MCS 0 MCS 15)</b>
36		16.0	16.0	
38	(36, 40)	16.0	16.0	16.0
40		16.0	16.0	
42		16.0	16.0	
44		16.0	16.0	
46	(44, 48)	16.0	16.0	16.0
48		16.0	16.0	
52		16.0	16.0	
54	(52, 56)	16.0	16.0	16.0
56		16.0	16.0	
60		16.0	16.0	
62	(60, 64)	16.0	16.0	16.0
64		16.0	16.0	
100		19.0	19.0	
102	(100, 104)	19.0	19.0	19.0
104		19.0	19.0	
108		19.0	19.0	
112		19.0	19.0	
110	(108, 112)	19.0	19.0	19.0
116		19.0	19.0	
118	(116, 120)	19.0	19.0	19.0
120		19.0	19.0	
124		19.0	19.0	
126	(124, 128)	19.0	19.0	19.0
128		19.0	19.0	
132		19.0	19.0	
134	(132, 136)	19.0	19.0	19.0
136		19.0	19.0	
140		19.0	19.0	
149				

<b>20 MHZ CHANNEL</b>	<b>40 MHZ CHANNEL</b>	<b>LEGACY OFDM RATES (6,9,12,18,24,36,48,54 MBPS)</b>	<b>802.11n HT20 RATES (MCS 0 MCS 15)</b>	<b>802.11n HT40 RATES (MCS 0 MCS 15)</b>
151	(149, 153)			
153				
157				
159	(157, 161)			
161				
165				

Net peak gain = 7dBi

## 11.5 EU Regulatory Domain 2.4 GHz Band

### 11.5.1 Dipole Dual Band Antenna Maximum Conducted Transmit Power Settings

The following is a transmit power table (EU domain) per dipole antenna in the 2.4 GHz band:

<b>20 MHZ CHANNEL</b>	<b>40 MHZ CHANNEL</b>	<b>LEGACY DSSS RATES (1, 2, 5.5, 11 MBPS)</b>	<b>LEGACY OFDM RATES (6,9,12,18,24,36, 48,54 MBPS)</b>	<b>802.11n HT20 RATES (MCS 0 MCS 15)</b>	<b>802.11n HT40 RATES (MCS 0 MCS15)</b>
1		10.0	10.0	10.0	
2		10.0	10.0	10.0	
3	(1, 5)	10.0	10.0	10.0	10.0
4	(2, 6)	10.0	10.0	10.0	10.0
5	(3, 7)	10.0	10.0	10.0	10.0
6	(4, 8)	10.0	10.0	10.0	10.0
7	(5, 9)	10.0	10.0	10.0	10.0
8	(6, 10)	10.0	10.0	10.0	10.0
9	(7, 11)	10.0	10.0	10.0	10.0
10	(8, 12)	10.0	10.0	10.0	10.0
11	(9, 13)	10.0	10.0	10.0	10.0
12		10.0	10.0	10.0	
13		10.0	10.0	10.0	

Net peak gain = 7dBi



### 11.5.2 Internal Dual Band Antenna Maximum Conducted Transmit Power Settings

The following is a transmit power table (EU domain) per internal dual band antenna in the 2.4 GHz band:

<b>20 MHZ CHANNEL</b>	<b>40 MHZ CHANNEL</b>	<b>LEGACY DSSS RATES (1, 2, 5.5, 11 MBPS)</b>	<b>LEGACY OFDM RATES (6,9,12,18,24,36, 48,54 MBPS)</b>	<b>802.11n HT20 RATES (MCS 0 MCS 15)</b>	<b>802.11n HT40 RATES (MCS 0 MCS15)</b>
1		15.0	15.0	15.0	
2		15.0	15.0	15.0	
3	(1, 5)	15.0	15.0	15.0	15.0
4	(2, 6)	15.0	15.0	15.0	15.0
5	(3, 7)	15.0	15.0	15.0	15.0
6	(4, 8)	15.0	15.0	15.0	15.0
7	(5, 9)	15.0	15.0	15.0	15.0
8	(6, 10)	15.0	15.0	15.0	15.0
9	(7, 11)	15.0	15.0	15.0	15.0
10	(8, 12)	15.0	15.0	15.0	15.0
11	(9, 13)	15.0	15.0	15.0	15.0
12		15.0	15.0	15.0	
13		15.0	15.0	15.0	

Net peak gain = 2dBi

### 11.5.3 Outdoor Omni Antenna Maximum Conducted Transmit Power Settings

The following is a transmit power table (EU domain) per outdoor omni antenna in the 2.4 GHz band:

<b>20 MHZ CHANNEL</b>	<b>40 MHZ CHANNEL</b>	<b>LEGACY DSSS RATES (1, 2, 5.5, 11 MBPS)</b>	<b>LEGACY OFDM RATES (6,9,12,18,24,36, 48,54 MBPS)</b>	<b>802.11n HT20 RATES (MCS 0 MCS 15)</b>	<b>802.11n HT40 RATES (MCS0 MCS15)</b>
1		13.5	13.5	13.5	
2		13.5	13.5	13.5	
3	(1, 5)	13.5	13.5	13.5	13.5
4	(2, 6)	13.5	13.5	13.5	13.5
5	(3, 7)	13.5	13.5	13.5	13.5
6	(4, 8)	13.5	13.5	13.5	13.5
7	(5, 9)	13.5	13.5	13.5	13.5
8	(6, 10)	13.5	13.5	13.5	13.5
9	(7, 11)	13.5	13.5	13.5	13.5
10	(8, 12)	13.5	13.5	13.5	13.5
11	(9, 13)	13.5	13.5	13.5	13.5
12		13.5	13.5	13.5	
13		13.5	13.5	13.5	

Net peak gain = 3.3dBi

### 11.5.4 Panel Antenna Maximum Conducted Transmit Power Settings

The following is a transmit power table (EU domain) per panel antenna in the 2.4 GHz band:

<b>20 MHZ CHANNEL</b>	<b>40 MHZ CHANNEL</b>	<b>LEGACY DSSS RATES (1, 2, 5.5, 11 MBPS)</b>	<b>LEGACY OFDM RATES (6,9,12,18,24,36, 48,54 MBPS)</b>	<b>802.11n HT20 RATES (MCS 0 MCS 15)</b>	<b>802.11n HT40 RATES (MCS0 MCS15)</b>
1		12.5	12.5	13.0	
2		12.5	12.5	12.5	
3	(1, 5)	12.5	12.5	12.5	12.5
4	(2, 6)	12.5	12.5	12.5	12.5
5	(3, 7)	12.5	12.5	12.5	12.5
6	(4, 8)	12.5	12.5	12.5	12.5
7	(5, 9)	12.5	12.5	12.5	12.5
8	(6, 10)	12.5	12.5	12.5	12.5
9	(7, 11)	12.5	12.5	12.5	12.5
10	(8, 12)	12.5	12.5	12.5	12.5
11	(9, 13)	12.5	12.5	12.5	12.5
12		12.5	12.5	12.5	
13		12.5	12.5	12.5	

Net peak gain = 4.5dBi

### 11.5.5 Patch Antenna Maximum Conducted Transmit Power Settings

The following is a transmit power table (EU domain) per patch antenna in the 2.4 GHz band:

<b>20 MHZ CHANNEL</b>	<b>40 MHZ CHANNEL</b>	<b>LEGACY DSSS RATES (1, 2, 5.5, 11 MBPS)</b>	<b>LEGACY OFDM RATES (6,9,12,18,24,36, 48,54 MBPS)</b>	<b>802.11n HT20 RATES (MCS 0 MCS 15)</b>	<b>802.11n HT40 RATES (MCS0 MCS15)</b>
1		13.0	13.0	13.0	
2		13.0	13.0	13.0	
3	(1, 5)	13.0	13.0	13.0	13.0
4	(2, 6)	13.0	13.0	13.0	13.0
5	(3, 7)	13.0	13.0	13.0	13.0
6	(4, 8)	13.0	13.0	13.0	13.0
7	(5, 9)	13.0	13.0	13.0	13.0
8	(6, 10)	13.0	13.0	13.0	13.0
9	(7, 11)	13.0	13.0	13.0	13.0
10	(8, 12)	13.0	13.0	13.0	13.0
11	(9, 13)	13.0	13.0	13.0	13.0
12		13.0	13.0	13.0	
13		13.0	13.0	13.0	

Net peak gain = 4dBi

## 11.6 EU Regulatory Domain 5 GHz Band

### 11.6.1 Dual Band Dipole Antenna Maximum Conducted Transmit Power Settings

The following is a transmit power table (EU domain) per dual band dipole antenna in the 5 GHz band:

<b>20 MHZ CHANNEL</b>	<b>40 MHZ CHANNEL</b>	<b>LEGACY OFDM RATES (6,9,12,18,24,36,48,54 MBPS)</b>	<b>802.11n HT20 RATES (MCS 0 MCS 15)</b>	<b>802.11n HT40 RATES (MCS 0 MCS 15)</b>
36		15.0	15.0	
38	(36, 40)	15.0	15.0	13.0
40		15.0	15.0	
42		15.0	15.0	
44		15.0	15.0	
46	(44, 48)	15.0	15.0	13.0
48		15.0	15.0	
52		15.0	15.0	
54	(52, 56)	15.0	15.0	15.0
56		15.0	15.0	
60		15.0	15.0	
62	(60, 64)	15.0	15.0	15.0
64		15.0	15.0	
100		19.0	19.0	
102	(100, 104)	19.0	19.0	19.0
104		19.0	19.0	
108		19.0	19.0	
112		19.0	19.0	
110	(108, 112)	19.0	19.0	19.0
116		19.0	19.0	
118	(116, 120)	19.0	19.0	19.0
120		19.0	19.0	
124		19.0	19.0	
126	(124, 128)	19.0	19.0	19.0
128		19.0	19.0	
132		19.0	19.0	
134	(132, 136)	19.0	19.0	19.0
136		19.0	19.0	
140		19.0	19.0	

<b>20 MHZ CHANNEL</b>	<b>40 MHZ CHANNEL</b>	<b>LEGACY OFDM RATES (6,9,12,18,24,36,48,54 MBPS)</b>	<b>802.11n HT20 RATES (MCS 0 MCS 15)</b>	<b>802.11n HT40 RATES (MCS 0 MCS 15)</b>
149				
151	(149, 153)			
153				
157				
159	(157, 161)			
161				
165				

Net peak gain = 5dBi

## 11.6.2 Internal Dual Band Antenna Maximum Conducted Transmit Power Settings

The following is a transmit power table (EU domain) per internal dual band antenna in the 5 GHz band:

<b>20 MHZ CHANNEL</b>	<b>40 MHZ CHANNEL</b>	<b>LEGACY OFDM RATES (6,9,12,18,24,36,48,54 MBPS)</b>	<b>802.11n HT20 RATES (MCS 0 MCS 15)</b>	<b>802.11n HT40 RATES (MCS 0 MCS 15)</b>
36		16.0	16.0	
38	(36,40)	16.0	16.0	16.0
40		16.0	16.0	
42		16.0	16.0	
44		16.0	16.0	
46	(44,48)	16.0	16.0	16.0
48		16.0	16.0	
52		16.0	16.0	
54	(52,56)	16.0	16.0	16.0
56		16.0	16.0	
60		16.0	16.0	
62	(60,64)	16.0	16.0	16.0
64		16.0	16.0	
100		18.0	18.0	
102	(100,104)	18.0	18.0	18.0
104		18.0	18.0	
108		18.0	18.0	
112		18.0	18.0	
110	(108,112)	18.0	18.0	18.0
116		18.0	18.0	
118	(116,120)	18.0	18.0	18.0
120		18.0	18.0	
124		18.0	18.0	
126	(124,128)	18.0	18.0	18.0
128		18.0	18.0	
132		18.0	18.0	
134	(132,136)	18.0	18.0	18.0
136		18.0	18.0	
140		18.0	18.0	
149				

<b>20 MHZ CHANNEL</b>	<b>40 MHZ CHANNEL</b>	<b>LEGACY OFDM RATES (6,9,12,18,24,36,48,54 MBPS)</b>	<b>802.11n HT20 RATES (MCS 0 MCS 15)</b>	<b>802.11n HT40 RATES (MCS 0 MCS 15)</b>
151	(149,153)			
153				
157				
159	(157,161)			
161				
165				

Net peak gain = 4.8dBi



### 11.6.3 Indoor Patch Antenna Maximum Conducted Transmit Power Settings

The following is a transmit power table (EU domain) per indoor patch antenna in the 5 GHz band:

<b>20 MHZ CHANNEL</b>	<b>40 MHZ CHANNEL</b>	<b>LEGACY OFDM RATES (6,9,12,18,24,36,48,54 MBPS)</b>	<b>802.11n HT20 RATES (MCS 0 MCS 15)</b>	<b>802.11n HT40 RATES (MCS 0 MCS 15)</b>
36		13.0	13.0	
38	(36, 40)	13.0	13.0	13.0
40		13.0	13.0	
42		13.0	13.0	
44		13.0	13.0	
46	(44, 48)	13.0	13.0	13.0
48		13.0	13.0	
52		13.0	13.0	
54	(52, 56)	13.0	13.0	13.0
56		13.0	13.0	
60		13.0	13.0	
62	(60, 64)	13.0	13.0	13.0
64		13.0	13.0	
100		19.0	19.0	
102	(100, 104)	19.0	19.0	19.0
104		19.0	19.0	
108		19.0	19.0	
112		19.0	19.0	
110	(108, 112)	19.0	19.0	19.0
116		19.0	19.0	
118	(116, 120)	19.0	19.0	19.0
120		19.0	19.0	
124		19.0	19.0	
126	(124, 128)	19.0	19.0	19.0
128		19.0	19.0	
132		19.0	19.0	
134	(132, 136)	19.0	19.0	19.0
136		19.0	19.0	
140		19.0	19.0	
149				

<b>20 MHZ CHANNEL</b>	<b>40 MHZ CHANNEL</b>	<b>LEGACY OFDM RATES (6,9,12,18,24,36,48,54 MBPS)</b>	<b>802.11n HT20 RATES (MCS 0 MCS 15)</b>	<b>802.11n HT40 RATES (MCS 0 MCS 15)</b>
151	(149, 153)			
153				
157				
159	(157, 161)			
161				
165				

Net peak gain = 7dBi

### 11.6.4 Outdoor Omni Antenna Transmit Power Settings

The following is a transmit power table (EU domain) per outdoor omni antenna in the 5 GHz band:

<b>20 MHZ CHANNEL</b>	<b>40 MHZ CHANNEL</b>	<b>LEGACY OFDM RATES (6,9,12,18,24,36,48,54 MBPS)</b>	<b>802.11n HT20 RATES (MCS 0 MCS 15)</b>	<b>802.11n HT40 RATES (MCS 0 MCS 15)</b>
36		15.5	15.5	
38	(36, 40)	15.5	15.5	15.5
40		15.5	15.5	
42		15.5	15.5	
44		15.5	15.5	
46	(44, 48)	15.5	15.5	15.5
48		15.5	15.5	
52		15.5	15.5	
54	(52, 56)	15.5	15.5	15.5
56		15.5	15.5	
60		15.5	15.5	
62	(60, 64)	15.5	15.5	15.5
64		15.5	15.5	
100		19.0	19.0	
102	(100, 104)	19.0	19.0	19.0
104		19.0	19.0	
108		19.0	19.0	
112		19.0	19.0	
110	(108, 112)	19.0	19.0	19.0
116		19.0	19.0	
118	(116, 120)	19.0	19.0	19.0
120		19.0	19.0	
124		19.0	19.0	
126	(124, 128)	19.0	19.0	19.0
128		19.0	19.0	
132		19.0	19.0	
134	(132, 136)	19.0	19.0	19.0
136		19.0	19.0	
140		19.0	19.0	
149				

<b>20 MHZ CHANNEL</b>	<b>40 MHZ CHANNEL</b>	<b>LEGACY OFDM RATES (6,9,12,18,24,36,48,54 MBPS)</b>	<b>802.11n HT20 RATES (MCS 0 MCS 15)</b>	<b>802.11n HT40 RATES (MCS 0 MCS 15)</b>
151	(149, 153)			
153				
157				
159	(157, 161)			
161				
165				

Net peak gain = 4.2dBi

### 11.6.4.1 Panel Antenna Maximum Conducted Transmit Power Settings

The following is a transmit power table (Japan domain) per panel antenna in the 5 GHz band:

<b>20 MHZ CHANNEL</b>	<b>40 MHZ CHANNEL</b>	<b>LEGACY OFDM RATES (6,9,12,18,24,36,48,54 MBPS)</b>	<b>802.11n HT20 RATES (MCS 0 MCS 15)</b>	<b>802.11n HT40 RATES (MCS 0 MCS 15)</b>
36		15.0	15.0	
38	(36, 40)	15.0	15.0	15.0
40		15.0	15.0	
42		15.0	15.0	
44		15.0	15.0	
46	(44, 48)	15.0	15.0	15.0
48		15.0	15.0	
52		15.0	15.0	
54	(52, 56)	15.0	15.0	15.0
56		15.0	15.0	
60		15.0	15.0	
62	(60, 64)	15.0	15.0	15.0
64		15.0	15.0	
100		19.0	19.0	
102	(100, 104)	19.0	19.0	19.0
104		19.0	19.0	
108		19.0	19.0	
112		19.0	19.0	
110	(108, 112)	19.0	19.0	19.0
116		19.0	19.0	
118	(116, 120)	19.0	19.0	19.0
120		19.0	19.0	
124		19.0	19.0	
126	(124, 128)	19.0	19.0	
128		19.0	19.0	
132		19.0	19.0	
134	(132, 136)	19.0	19.0	19.0
136		19.0	19.0	
140		19.0	19.0	
149				

<b>20 MHZ CHANNEL</b>	<b>40 MHZ CHANNEL</b>	<b>LEGACY OFDM RATES (6,9,12,18,24,36,48,54 MBPS)</b>	<b>802.11n HT20 RATES (MCS 0 MCS 15)</b>	<b>802.11n HT40 RATES (MCS 0 MCS 15)</b>
151	(149, 153)			
153				
157				
159	(157, 161)			
161				
165				

Net peak gain = 5dBi

## ***RFS4011 Regulatory Domains***

### **12.1 US Regulatory Domain 2.4 GHz Band**

#### ***12.1.1 Facade Antenna Model***

The following is the RFS4011 facade antenna model for 2.4 GHz, its peak gain is 2.1dBi:

<b><i>Part Number</i></b>
ML-2452-PTA4M3X3-1

#### **12.1.1.1 Facade Antenna Maximum Conducted Transmit Power Settings**

The following is a transmit power table (US domain) per facade antenna in the 2.4 GHz band:

<b><i>20 MHZ CHANNEL</i></b>	<b><i>40 MHZ CHANNEL</i></b>	<b><i>LEGACY DSSS RATES (1, 2, 5.5, 11 MBPS)</i></b>	<b><i>LEGACY OFDM RATES (6,9,12,18,24,36, 48,54 MBPS)</i></b>	<b><i>802.11n HT20 RATES (MCS 0 MCS 15)</i></b>	<b><i>802.11n HT40 RATES (MCS 0 MCS15)</i></b>
1		18.5	15.0	15.5	
2		18.5	15.0	15.5	
3	(1, 5)	18.5	15.0	15.5	12.5
4	(2, 6)	18.5	15.0	15.5	12.5
5	(3, 7)	18.5	15.0	15.5	12.5
6	(4, 8)	21.0	15.0	16.0	15.5
7	(5, 9)	20.0	15.5	15.5	12.5
8	(6, 10)	20.0	15.5	15.5	12.5
9	(7, 11)	20.0	15.5	15.5	12.5
10		20.0	15.5	15.5	
11		20.0	15.5	15.5	

## 12.1.2 MIMO Patch Antenna Model

The following is the RFS4011 MIMO patch antenna model for 2.4 GHz, its peak gain is 3.5dBi:

<b>Part Number</b>
ML-2452-PTA3M3-036

### 12.1.2.1 MIMO Patch Antenna Maximum Conducted Transmit Power Settings

The following is a transmit power table (US domain) per MIMO patch antenna in the 2.4 GHz band:

<b>20 MHZ CHANNEL</b>	<b>40 MHZ CHANNEL</b>	<b>LEGACY DSSS RATES (1, 2, 5.5, 11 MBPS)</b>	<b>LEGACY OFDM RATES (6,9,12,18,24,36, 48,54 MBPS)</b>	<b>802.11n HT20 RATES (MCS 0 MCS 15)</b>	<b>802.11n HT40 RATES (MCS 0 MCS15)</b>
1		18.5	13.5	14.5	
2		18.5	13.5	14.5	
3	(1, 5)	18.5	13.5	14.5	11.5
4	(2, 6)	18.5	13.5	14.5	11.5
5	(3, 7)	18.5	13.5	14.5	11.5
6	(4, 8)	19.5	14.0	16.0	15.5
7	(5, 9)	19.0	14.0	14.5	11.5
8	(6, 10)	19.0	14.0	14.5	11.5
9	(7, 11)	19.0	14.0	14.5	11.5
10		19.0	14.0	14.5	
11		19.0	14.0	14.5	



### 12.1.3 Dipole Antenna Model

The following is the RFS4011 dipole antenna model for 2.4 GHz, its peak gain is 3.1dBi:

<b>Part Number</b>
ML-2452-HPA5-036

#### 12.1.3.1 Dipole Antenna Maximum Conducted Transmit Power Settings

The following is a transmit power table (US domain) per dipole antenna in the 2.4 GHz band:

<b>20 MHZ CHANNEL</b>	<b>40 MHZ CHANNEL</b>	<b>LEGACY DSSS RATES (1, 2, 5.5, 11 MBPS)</b>	<b>LEGACY OFDM RATES (6,9,12,18,24,36, 48,54 MBPS)</b>	<b>802.11n HT20 RATES (MCS 0 MCS 15)</b>	<b>802.11n HT40 RATES (MCS 0 MCS15)</b>
1		19.0	14.0	14.0	
2		19.0	14.0	14.0	
3	(1, 5)	19.0	14.0	14.0	11.0
4	(2, 6)	19.0	14.0	14.0	11.0
5	(3, 7)	19.0	14.0	14.0	11.0
6	(4, 8)	20.0	15.0	15.5	14.0
7	(5, 9)	18.5	13.5	13.5	11.0
8	(6, 10)	18.5	13.5	13.5	11.0
9	(7, 11)	18.5	13.5	13.5	11.0
10		18.5	13.5	13.5	
11		18.5	13.5	13.5	

### 12.1.4 High-Gain Patch Antenna Model

The following is the RFS4011 high-gain patch antenna model for 2.4 GHz, its peak gain is 7.5 dBi:

<b>Part Number</b>
ML-2452-PNA7-01R

#### 12.1.4.1 High-Gain Patch Antenna Maximum Conducted Transmit Power Settings

The following is a transmit power table (US domain) per high-gain patch antenna in the 2.4 GHz band:

<b>20 MHZ CHANNEL</b>	<b>40 MHZ CHANNEL</b>	<b>LEGACY DSSS RATES (1, 2, 5.5, 11 MBPS)</b>	<b>LEGACY OFDM RATES (6,9,12,18,24,36, 48,54 MBPS)</b>	<b>802.11n HT20 RATES (MCS 0 MCS 15)</b>	<b>802.11n HT40 RATES (MCS0 MCS15)</b>
1		15.5	9.5	11.0	
2		15.5	9.5	11.0	
3	(1, 5)	15.5	9.5	11.0	7.5
4	(2, 6)	15.5	9.5	11.0	7.5
5	(3, 7)	15.5	9.5	11.0	7.5
6	(4, 8)	15.5	10.5	15.0	12.5
7	(5, 9)	16.0	9.5	11.0	8.0
8	(6, 10)	16.0	9.5	11.0	8.0
9	(7, 11)	16.0	9.5	11.0	8.0
10		16.0	9.5	11.0	
11		16.0	9.5	11.0	

## 12.2 US Regulatory Domain 5 GHz Band

### 12.2.1 Facade Antenna Model

The following is the RFS4011 facade antenna model for 5 GHz, its peak gain is 3.95dBi:

<b>Part Number</b>
ML-2452-PTA4M3X3-1

#### 12.2.1.1 Facade Antenna Maximum Conducted Transmit Power Settings

The following is a transmit power table (US domain) per facade antenna in the 5 GHz band:

<b>20 MHZ CHANNEL</b>	<b>40 MHZ CHANNEL</b>	<b>LEGACY OFDM RATES (6,9,12,18,24,36,48,54 MBPS)</b>	<b>802.11n HT20 RATES (MCS 0 MCS 15)</b>	<b>802.11n HT40 RATES (MCS 0 MCS 15)</b>
36		8.5	10.0	
38	(36, 40)			10.0
40		8.5	10.0	
42		8.5	10.0	
44		8.5	10.0	
46	(44, 48)			10.0
48		8.5	10.0	
52				
54	(52, 56)			
56				
60				
62	(60, 64)			
64				
100				
102	(100, 104)			
104				
108				
112				
110	(108, 112)			
116				
118	(116, 120)			
120				
124				
126	(124, 128)			
128				

<b>20 MHZ CHANNEL</b>	<b>40 MHZ CHANNEL</b>	<b>LEGACY OFDM RATES (6,9,12,18,24,36,48,54 MBPS)</b>	<b>802.11n HT20 RATES (MCS 0 MCS 15)</b>	<b>802.11n HT40 RATES (MCS 0 MCS 15)</b>
132				
134	(132, 136)			
136				
140				
149		11.0	12.5	
151	(149, 153)			12.5
153		11.0	12.5	
157		11.5	12.5	
159	(157, 161)			13.0
161		12.0	13.0	
165		12.0	13.0	

## 12.2.2 MIMO Patch Antenna Model

The following is the RFS4011 MIMO patch antenna model for 5 GHz, its peak gain is 5.0dBi:

<b>Part Number</b>
ML-2452-PTA3M3-036

### 12.2.2.1 MIMO Patch Antenna Maximum Conducted Transmit Power Settings

The following is a transmit power table (US domain) per MIMO patch antenna in the 5 GHz band:

<b>20 MHZ CHANNEL</b>	<b>40 MHZ CHANNEL</b>	<b>LEGACY OFDM RATES (6,9,12,18,24,36,48,54 MBPS)</b>	<b>802.11n HT20 RATES (MCS 0 MCS 15)</b>	<b>802.11n HT40 RATES (MCS 0 MCS 15)</b>
36		7.5	11.0	
38	(36,40)			11.0
40		7.5	11.0	
42		7.5	11.0	
44		7.5	11.0	
46	(44,48)			11.0
48		7.5	11.0	
52				
54	(52,56)			
56				
60				
62	(60,64)			
64				
100				
102	(100,104)			
104				
108				
112				
110	(108,112)			
116				
118	(116,120)			
120				
124				
126	(124,128)			
128				

<b>20 MHZ CHANNEL</b>	<b>40 MHZ CHANNEL</b>	<b>LEGACY OFDM RATES (6,9,12,18,24,36,48,54 MBPS)</b>	<b>802.11n HT20 RATES (MCS 0 MCS 15)</b>	<b>802.11n HT40 RATES (MCS 0 MCS 15)</b>
132				
134	(132,136)			
136				
140				
149		10.5	13.5	
151	(149,153)			13.5
153		10.5	13.5	
157		11.0	13.5	
159	(157,161)			14.0
161		11.5	14.0	
165		11.5	14.0	

### 12.2.3 Dipole Model

The following is the RFS4011 dipole antenna model for 5 GHz, its peak gain is 4.6dBi:

<b>Part Number</b>
ML-2452-HPA5-036

#### 12.2.3.1 Dipole Antenna Maximum Conducted Transmit Power Settings

The following is a transmit power table (US domain) per dipole antenna in the 5 GHz band:

<b>20 MHZ CHANNEL</b>	<b>40 MHZ CHANNEL</b>	<b>LEGACY OFDM RATES (6,9,12,18,24,36,48,54 MBPS)</b>	<b>802.11n HT20 RATES (MCS 0 MCS 15)</b>	<b>802.11n HT40 RATES (MCS 0 MCS 15)</b>
36		8.0	11.0	
38	(36, 40)			11.0
40		8.0	11.0	
42		8.0	11.0	
44		8.0	11.0	
46	(44, 48)			11.0
48		8.0	11.0	
52				
54	(52, 56)			
56				
60				
62	(60, 64)			
64				
100				
102	(100, 104)			
104				
108				
112				
110	(108, 112)			
116				
118	(116, 120)			
120				
124				
126	(124, 128)			
128				
132				
134	(132, 136)			

<b>20 MHZ CHANNEL</b>	<b>40 MHZ CHANNEL</b>	<b>LEGACY OFDM RATES (6,9,12,18,24,36,48,54 MBPS)</b>	<b>802.11n HT20 RATES (MCS 0 MCS 15)</b>	<b>802.11n HT40 RATES (MCS 0 MCS 15)</b>
136				
140				
149		10.5	13.5	
151	(149, 153)			13.5
153		10.5	13.5	
157		11.0	13.5	
159	(157, 161)			14.0
161		11.5	14.0	
165		11.5	14.0	



## 12.2.4 High-Gain Patch Antenna Model

The following is the RFS4011 high-gain patch antenna model for 5 GHz, its peak gain is between 6.3 -10dBi:

<b>Part Number</b>
ML-2452-PNA7-01R

### 12.2.4.1 High-Gain Patch Antenna Transmit Power Settings

The following is a transmit power table (US domain) per high-gain patch antenna in the 5 GHz band:

<b>20 MHZ CHANNEL</b>	<b>40 MHZ CHANNEL</b>	<b>LEGACY OFDM RATES (6,9,12,18,24,36,48,54 MBPS)</b>	<b>802.11n HT20 RATES (MCS 0 MCS 15)</b>	<b>802.11n HT40 RATES (MCS 0 MCS 15)</b>
36		6.5	10.5	
38	(36, 40)			9.5
40		6.5	10.5	
42		6.5	10.5	
44		6.5	10.5	
46	(44, 48)			9.5
48		6.5	10.5	
52				
54	(52, 56)			
56				
60				
62	(60, 64)			
64				
100				
102	(100, 104)			
104				
108				
112				
110	(108, 112)			
116				
118	(116, 120)			
120				
124				
126	(124, 128)			
128				

<b>20 MHZ CHANNEL</b>	<b>40 MHZ CHANNEL</b>	<b>LEGACY OFDM RATES (6,9,12,18,24,36,48,54 MBPS)</b>	<b>802.11n HT20 RATES (MCS 0 MCS 15)</b>	<b>802.11n HT40 RATES (MCS 0 MCS 15)</b>
132				
134	(132, 136)			
136				
140				
149		6.5	11.0	
151	(149, 153)			11.0
153		6.5	11.0	
157		7.0	11.0	
159	(157, 161)			11.5
161		7.5	11.5	
165		7.5	11.5	

## 12.3 Canada Regulatory Domain 2.4 GHz Band

### 12.3.1 Facade Antenna Model

The following is the RFS4011 facade antenna model for 2.4 GHz, its peak gain is 2.1dBi:

<i>Part Number</i>
ML-2452-PTA4M3X3-1

#### 12.3.1.1 Facade Antenna Maximum Conducted Transmit Power Settings

The following is a transmit power table (Canadian domain) per facade antenna in the 2.4 GHz band:

<b>20 MHZ CHANNEL</b>	<b>40 MHZ CHANNEL</b>	<b>LEGACY DSSS RATES (1, 2, 5.5, 11 MBPS)</b>	<b>LEGACY OFDM RATES (6,9,12,18,24,36, 48,54 MBPS)</b>	<b>802.11n HT20 RATES (MCS 0 MCS 15)</b>	<b>802.11n HT40 RATES (MCS 0 MCS15)</b>
1		18.5	16.0	15.5	
2		18.5	16.0	15.5	
3	(1, 5)	18.5	16.0	15.5	12.5
4	(2, 6)	18.5	16.0	15.5	12.5
5	(3, 7)	18.5	16.0	15.5	12.5
6	(4, 8)	21.0	16.0	16.0	15.5
7	(5, 9)	20.0	16.0	15.5	12.5
8	(6, 10)	20.0	16.0	15.5	12.5
9	(7, 11)	20.0	16.0	15.5	12.5
10		20.0	16.0	15.5	
11		20.0	16.0	15.5	

### 12.3.2 MIMO Patch Antenna Model

The following is the RFS4011 MIMO patch antenna model for 2.4 GHz, its peak gain is 3.5dBi:

<b>Part Number</b>
ML-2452-PTA3M3-036

#### 12.3.2.1 MIMO Patch Antenna Maximum Conducted Transmit Power Settings

The following is a transmit power table (Canadian domain) per MIMO patch antenna in the 2.4 GHz band:

<b>20 MHZ CHANNEL</b>	<b>40 MHZ CHANNEL</b>	<b>LEGACY DSSS RATES (1, 2, 5.5, 11 MBPS)</b>	<b>LEGACY OFDM RATES (6,9,12,18,24,36, 48,54 MBPS)</b>	<b>802.11n HT20 RATES (MCS 0 MCS 15)</b>	<b>802.11n HT40 RATES (MCS 0 MCS15)</b>
1		18.5	16.0	14.5	
2		18.5	16.0	14.5	
3	(1, 5)	18.5	16.0	14.5	11.5
4	(2, 6)	18.5	16.0	14.5	11.5
5	(3, 7)	18.5	16.0	14.5	11.5
6	(4, 8)	21.0	16.0	16.0	15.5
7	(5, 9)	19.0	16.0	14.5	11.5
8	(6, 10)	19.0	16.0	14.5	11.5
9	(7, 11)	19.0	16.0	14.5	11.5
10		19.0	16.0	14.5	
11		19.0	16.0	14.5	

### 12.3.3 Dipole Antenna Model

The following is the RFS4011 dipole antenna model for 2.4 GHz, its peak gain is 3.1dBi:

<b>Part Number</b>
ML-2452-HPA5-036

#### 12.3.3.1 Dipole Antenna Maximum Conducted Transmit Power Settings

The following is a transmit power table (Canadian domain) per dipole antenna in the 2.4 GHz band:

<b>20 MHZ CHANNEL</b>	<b>40 MHZ CHANNEL</b>	<b>LEGACY DSSS RATES (1, 2, 5.5, 11 MBPS)</b>	<b>LEGACY OFDM RATES (6,9,12,18,24,36, 48,54 MBPS)</b>	<b>802.11n HT20 RATES (MCS 0 MCS 15)</b>	<b>802.11n HT40 RATES (MCS 0 MCS15)</b>
1		19.0	14.0	14.0	
2		19.0	14.0	14.0	
3	(1, 5)	19.0	14.0	14.0	11.0
4	(2, 6)	19.0	14.0	14.0	11.0
5	(3, 7)	19.0	14.0	14.0	11.0
6	(4, 8)	21.5	15.5	15.5	14.0
7	(5, 9)	18.5	13.5	13.5	11.0
8	(6, 10)	18.5	13.5	13.5	11.0
9	(7, 11)	18.5	13.5	13.5	11.0
10		18.5	13.5	13.5	
11		18.5	13.5	13.5	

### 12.3.4 High-Gain Antenna Model

The following is the RFS4011 high-gain antenna model for 2.4 GHz, its peak gain is 7.5dBi:

<b>Part Number</b>
ML-2452-PNA7-01R

#### 12.3.4.1 High-Gain Antenna Maximum Conducted Transmit Power Settings

The following is a transmit power table (Canadian domain) per high-gain antenna in the 2.4 GHz band:

<b>20 MHZ CHANNEL</b>	<b>40 MHZ CHANNEL</b>	<b>LEGACY DSSS RATES (1, 2, 5.5, 11 MBPS)</b>	<b>LEGACY OFDM RATES (6,9,12,18,24,36, 48,54 MBPS)</b>	<b>802.11n HT20 RATES (MCS 0 MCS 15)</b>	<b>802.11n HT40 RATES (MCS0 MCS15)</b>
1		17.0	11.0	11.0	
2		17.0	11.0	11.0	
3	(1, 5)	17.0	11.0	11.0	7.5
4	(2, 6)	17.0	11.0	11.0	7.5
5	(3, 7)	17.0	11.0	11.0	7.5
6	(4, 8)	20.0	15.0	15.0	12.5
7	(5, 9)	17.0	11.0	11.0	8.0
8	(6, 10)	17.0	11.0	11.0	8.0
9	(7, 11)	17.0	11.0	11.0	8.0
10		17.0	11.0	11.0	
11		17.0	11.0	11.0	

## 12.4 Canada Regulatory Domain 5 GHz Band

### 12.4.1 Facade Antenna Model

The following is the RFS4011 facade antenna model for 5 GHz, its peak gain is 3.95dBi:

<i>Part Number</i>
ML-2452-PTA4M3X3-1

#### 12.4.1.1 Facade Antenna Maximum Conducted Transmit Power Settings

The following is a transmit power table (Canadian domain) per facade antenna in the 5 GHz band:

<b>20 MHZ CHANNEL</b>	<b>40 MHZ CHANNEL</b>	<b>LEGACY OFDM RATES (6,9,12,18,24,36,48,54 MBPS)</b>	<b>802.11n HT20 RATES (MCS 0 MCS 15)</b>	<b>802.11n HT40 RATES (MCS 0 MCS 15)</b>
36		10.0	10.0	
38	(36, 40)			10.0
40		10.0	10.0	
42		10.0	10.0	
44		10.0	10.0	
46	(44, 48)			10.0
48		10.0	10.0	
52				
54	(52, 56)			
56				
60				
62	(60, 64)			
64				
100				
102	(100, 104)			
104				
108				
112				
110	(108, 112)			
116				
118	(116, 120)			
120				
124				

<b>20 MHZ CHANNEL</b>	<b>40 MHZ CHANNEL</b>	<b>LEGACY OFDM RATES (6,9,12,18,24,36,48,54 MBPS)</b>	<b>802.11n HT20 RATES (MCS 0 MCS 15)</b>	<b>802.11n HT40 RATES (MCS 0 MCS 15)</b>
126	(124, 128)			
128				
132				
134	(132, 136)			
136				
140				
149		12.5	12.5	
151	(149, 153)			12.5
153		12.5	12.5	
157		12.5	12.5	
159	(157, 161)			13.0
161		13.0	13.0	
165		13.0	13.0	



## 12.4.2 MIMO Patch Antenna Model

The following is the RFS4011 MIMO patch antenna model for 5 GHz, its peak gain is 5dBi:

<b>Part Number</b>
ML-2452-PTA3M3-036

### 12.4.2.1 MIMO Patch Antenna Maximum Conducted Transmit Power Settings

The following is a transmit power table (Canadian domain) per MIMO patch antenna in the 5 GHz band:

<b>20 MHZ CHANNEL</b>	<b>40 MHZ CHANNEL</b>	<b>LEGACY OFDM RATES (6,9,12,18,24,36,48,54 MBPS)</b>	<b>802.11n HT20 RATES (MCS 0 MCS 15)</b>	<b>802.11n HT40 RATES (MCS 0 MCS 15)</b>
36		11.0	11.0	
38	(36,40)			11.0
40		11.0	11.0	
42		11.0	11.0	
44		11.0	11.0	
46	(44,48)			11.0
48		11.0	11.0	
52				
54	(52,56)			
56				
60				
62	(60,64)			
64				
100				
102	(100,104)			
104				
108				
112				
110	(108,112)			
116				
118	(116,120)			
120				
124				
126	(124,128)			
128				

<b>20 MHZ CHANNEL</b>	<b>40 MHZ CHANNEL</b>	<b>LEGACY OFDM RATES (6,9,12,18,24,36,48,54 MBPS)</b>	<b>802.11n HT20 RATES (MCS 0 MCS 15)</b>	<b>802.11n HT40 RATES (MCS 0 MCS 15)</b>
132				
134	(132,136)			
136				
140				
149		13.5	13.5	
151	(149,153)			13.5
153		13.5	13.5	
157		13.5	13.5	
159	(157,161)			14.0
161		14.0	14.0	
165		14.0	14.0	

### 12.4.3 Dipole Antenna Model

The following is the RFS4011 dipole antenna model for 5 GHz, its peak gain is 4.6dBi:

<b>Part Number</b>
ML-2452-HPA5-036

#### 12.4.3.1 Dipole Antenna Maximum Conducted Transmit Power Settings

The following is a transmit power table (Canadian domain) per dipole antenna in the 5 GHz band:

<b>20 MHZ CHANNEL</b>	<b>40 MHZ CHANNEL</b>	<b>LEGACY OFDM RATES (6,9,12,18,24,36,48,54 MBPS)</b>	<b>802.11n HT20 RATES (MCS 0 MCS 15)</b>	<b>802.11n HT40 RATES (MCS 0 MCS 15)</b>
36		11.0	11.0	
38	(36, 40)			11.0
40		11.0	11.0	
42		11.0	11.0	
44		11.0	11.0	
46	(44, 48)			11.0
48		11.0	11.0	
52				
54	(52, 56)			
56				
60				
62	(60, 64)			
64				
100				
102	(100, 104)			
104				
108				
112				
110	(108, 112)			
116				
118	(116, 120)			
120				
124				
126	(124, 128)			
128				

<b>20 MHZ CHANNEL</b>	<b>40 MHZ CHANNEL</b>	<b>LEGACY OFDM RATES (6,9,12,18,24,36,48,54 MBPS)</b>	<b>802.11n HT20 RATES (MCS 0 MCS 15)</b>	<b>802.11n HT40 RATES (MCS 0 MCS 15)</b>
132				
134	(132, 136)			
136				
140				
149		13.5	13.5	
151	(149, 153)			13.5
153		13.5	13.5	
157		13.5	13.5	
159	(157, 161)			14.0
161		14.0	14.0	
165		14.0	14.0	

### 12.4.4 High-Gain Antenna Model

The following is the high-gain antenna model for 5 GHz, its peak gain is from 6.3 - 10dBi:

<b>Part Number</b>
ML-2452-PNA7-01R

#### 12.4.4.1 High-Gain Antenna Transmit Power Settings

The following is a transmit power table (Canadian domain) per high-gain antenna in the 5 GHz band:

<b>20 MHZ CHANNEL</b>	<b>40 MHZ CHANNEL</b>	<b>LEGACY OFDM RATES (6,9,12,18,24,36,48,54 MBPS)</b>	<b>802.11n HT20 RATES (MCS 0 MCS 15)</b>	<b>802.11n HT40 RATES (MCS 0 MCS 15)</b>
36		10.5	10.5	
38	(36, 40)			9.5
40		10.5	10.5	
42		10.5	10.5	
44		10.5	10.5	
46	(44, 48)			9.5
48		10.5	10.5	
52				
54	(52, 56)			
56				
60				
62	(60, 64)			
64				
100				
102	(100, 104)			
104				
108				
112				
110	(108, 112)			
116				
118	(116, 120)			
120				
124				
126	(124, 128)			
128				

<b>20 MHZ CHANNEL</b>	<b>40 MHZ CHANNEL</b>	<b>LEGACY OFDM RATES (6,9,12,18,24,36,48,54 MBPS)</b>	<b>802.11n HT20 RATES (MCS 0 MCS 15)</b>	<b>802.11n HT40 RATES (MCS 0 MCS 15)</b>
132				
134	(132, 136)			
136				
140				
149		11.0	11.0	
151	(149, 153)			11.0
153		11.0	11.0	
157		11.0	11.0	
159	(157, 161)			11.5
161		11.5	11.5	
165		11.5	11.5	

## 12.5 EU Regulatory Domain 2.4 GHz Band

### 12.5.1 Facade Antenna Model

The following is the RFS4011 facade antenna model for 2.4 GHz, the peak gain is 2.1dBi:

<b>Part Number</b>
ML-2452-PTA4M3X3-1

#### 12.5.1.1 Facade Antenna Maximum Conducted Transmit Power Settings

The following is a transmit power table (EU domain) per facade antenna in the 2.4 GHz band:

<b>20 MHZ CHANNEL</b>	<b>40 MHZ CHANNEL</b>	<b>LEGACY DSSS RATES (1, 2, 5.5, 11 MBPS)</b>	<b>LEGACY OFDM RATES (6,9,12,18,24,36, 48,54 MBPS)</b>	<b>802.11n HT20 RATES (MCS 0 MCS 15)</b>	<b>802.11n HT40 RATES (MCS 0 MCS15)</b>
1		6.5	4.0	4.0	
2		6.0	3.5	3.5	
3	(1, 5)	6.0	3.5	3.5	4.0
4	(2, 6)	6.0	3.5	3.5	3.5
5	(3, 7)	6.0	3.5	3.5	3.5
6	(4, 8)	6.0	3.5	3.5	3.5
7	(5, 9)	6.0	3.5	3.5	3.5
8	(6, 10)	6.0	3.5	3.5	3.5
9	(7, 11)	6.0	3.5	3.5	3.5
10		6.0	3.5	3.5	3.5
11		6.0	3.5	3.5	3.5
12		6.0	3.5	3.5	
13		6.0	3.5	3.5	
14					

## 12.5.2 MIMO Patch Antenna Model

The following is the RFS4011 MIMO patch antenna model for 2.4 GHz, its peak gain is 3.5dBi:

<b>Part Number</b>
ML-2452-PTA3M3-036

### 12.5.2.1 MIMO Patch Antenna Maximum Conducted Transmit Power Settings

The following is a transmit power table (EU domain) per MIMO patch antenna in the 2.4 GHz band:

<b>20 MHZ CHANNEL</b>	<b>40 MHZ CHANNEL</b>	<b>LEGACY DSSS RATES (1, 2, 5.5, 11 MBPS)</b>	<b>LEGACY OFDM RATES (6,9,12,18,24,36, 48,54 MBPS)</b>	<b>802.11n HT20 RATES (MCS 0 MCS 15)</b>	<b>802.11n HT40 RATES (MCS 0 MCS15)</b>
1		7.5	5.5	5.5	
2		7.5	5.5	5.5	
3	(1, 5)	7.5	5.5	5.5	6.0
4	(2, 6)	7.5	5.5	5.5	6.0
5	(3, 7)	7.5	5.5	5.5	6.0
6	(4, 8)	7.5	5.5	5.5	6.0
7	(5, 9)	7.5	5.5	5.5	6.0
8	(6, 10)	7.5	5.5	5.5	6.0
9	(7, 11)	7.5	5.5	5.5	6.0
10		7.5	5.5	5.5	6.0
11		7.5	5.5	5.5	6.0
12		7.5	5.5	5.5	
13		7.5	5.5	5.5	
14					



### 12.5.3 Dipole Antenna Model

The following is the RFS4011 dipole antenna model for 2.4 GHz, its peak gain is 3.1dBi:

<b>Part Number</b>
ML-2452-HPA5-036

#### 12.5.3.1 Dipole Antenna Maximum Conducted Transmit Power Settings

The following is a transmit power table (EU domain) per dipole antenna in the 2.4 GHz band:

<b>20 MHZ CHANNEL</b>	<b>40 MHZ CHANNEL</b>	<b>LEGACY DSSS RATES (1, 2, 5.5, 11 MBPS)</b>	<b>LEGACY OFDM RATES (6,9,12,18,24,36, 48,54 MBPS)</b>	<b>802.11n HT20 RATES (MCS 0 MCS 15)</b>	<b>802.11n HT40 RATES (MCS 0 MCS15)</b>
1		8.5	6.5	6.5	
2		8.5	6.5	6.5	
3	(1, 5)	8.5	6.5	6.5	7.0
4	(2, 6)	8.5	6.5	6.5	7.0
5	(3, 7)	8.5	6.5	6.5	7.0
6	(4, 8)	8.5	6.5	6.5	7.0
7	(5, 9)	8.5	6.5	6.5	7.0
8	(6, 10)	8.5	6.5	6.5	7.0
9	(7, 11)	8.5	6.5	6.5	7.0
10		8.5	6.5	6.5	7.0
11		8.5	6.5	6.5	7.0
12		8.5	6.5	6.5	
13		8.5	6.5	6.5	
14					

## 12.5.4 High-Gain Antenna Model

The following is the RFS4011 high-gain antenna model for 2.4 GHz, its peak gain is 7.5dBi:

<b>Part Number</b>
ML-2452-PNA7-01R

### 12.5.4.1 High-Gain Antenna Maximum Conducted Transmit Power Settings

The following is a transmit power table (EU domain) per high-gain antenna in the 2.4 GHz band:

<b>20 MHZ CHANNEL</b>	<b>40 MHZ CHANNEL</b>	<b>LEGACY DSSS RATES (1, 2, 5.5, 11 MBPS)</b>	<b>LEGACY OFDM RATES (6,9,12,18,24,36, 48,54 MBPS)</b>	<b>802.11n HT20 RATES (MCS 0 MCS 15)</b>	<b>802.11n HT40 RATES (MCS0 MCS15)</b>
1		3.0	1.0	1.0	
2		3.0	0.5	0.5	
3	(1, 5)	3.0	0.5	0.5	1.0
4	(2, 6)	3.0	0.5	0.5	0.5
5	(3, 7)	3.0	0.5	0.5	0.5
6	(4, 8)	3.0	0.5	0.5	0.5
7	(5, 9)	3.0	0.5	0.5	0.5
8	(6, 10)	3.0	0.5	0.5	0.5
9	(7, 11)	3.0	0.5	0.5	0.5
10		3.0	0.5	0.5	0.5
11		3.0	0.5	0.5	0.5
12		3.0	0.5	0.5	
13		3.0	1.0	0.5	
14					

## 12.6 EU Regulatory Domain 5 GHz Band

### 12.6.1 Facade Antenna Model

The following is the RFS4011 facade antenna model for 5 GHz, its peak gain is 3.95dBi:

<i>Part Number</i>
ML-2452-PTA4M3X3-1

#### 12.6.1.1 Facade Antenna Maximum Conducted Transmit Power Settings

The following is a transmit power table (EU domain) per facade antenna in the 5 GHz band:

<b>20 MHZ CHANNEL</b>	<b>40 MHZ CHANNEL</b>	<b>LEGACY OFDM RATES (6,9,12,18,24,36,48,54 MBPS)</b>	<b>802.11n HT20 RATES (MCS 0 MCS 15)</b>	<b>802.11n HT40 RATES (MCS 0 MCS 15)</b>
36		8.5	8.5	
38	(36, 40)			9.5
40		8.5	8.5	
42		8.5	8.5	
44		8.5	8.5	
46	(44, 48)			10.0
48		9.0	9.0	
52				
54	(52, 56)			
56				
60				
62	(60, 64)			
64				
100				
102	(100, 104)			
104				
108				
112				
110	(108, 112)			
116				
118	(116, 120)			
120				
124				

<b>20 MHZ CHANNEL</b>	<b>40 MHZ CHANNEL</b>	<b>LEGACY OFDM RATES (6,9,12,18,24,36,48,54 MBPS)</b>	<b>802.11n HT20 RATES (MCS 0 MCS 15)</b>	<b>802.11n HT40 RATES (MCS 0 MCS 15)</b>
126	(124, 128)			
128				
132				
134	(132, 136)			
136				
140				
149				
151	(149, 153)			
153				
157				
159	(157, 161)			
161				
165				

## 12.6.2 MIMO Patch Antenna Model

The following is the RFS4011 MIMO patch antenna model for 5 GHz, its peak gain is 5dBi:

<b>Part Number</b>
ML-2452-PTA3M3-036

### 12.6.2.1 MIMO Patch Antenna Maximum Conducted Transmit Power Settings

The following is a transmit power table (EU domain) per MIMO patch antenna in the 5 GHz band:

<b>20 MHZ CHANNEL</b>	<b>40 MHZ CHANNEL</b>	<b>LEGACY OFDM RATES (6,9,12,18,24,36,48,54 MBPS)</b>	<b>802.11n HT20 RATES (MCS 0 MCS 15)</b>	<b>802.11n HT40 RATES (MCS 0 MCS 15)</b>
36		8.5	8.5	
38	(36,40)			9.5
40		8.5	8.5	
42		8.5	8.5	
44		8.5	8.5	
46	(44,48)			10.0
48		9.0	9.0	
52				
54	(52,56)			
56				
60				
62	(60,64)			
64				
100				
102	(100,104)			
104				
108				
112				
110	(108,112)			
116				
118	(116,120)			
120				
124				
126	(124,128)			
128				

<b>20 MHZ CHANNEL</b>	<b>40 MHZ CHANNEL</b>	<b>LEGACY OFDM RATES (6,9,12,18,24,36,48,54 MBPS)</b>	<b>802.11n HT20 RATES (MCS 0 MCS 15)</b>	<b>802.11n HT40 RATES (MCS 0 MCS 15)</b>
132				
134	(132,136)			
136				
140				
149				
151	(149,153)			
153				
157				
159	(157,161)			
161				
165				

### 12.6.3 Dipole Model

The following is the RFS4011 dipole antenna model for 5 GHz, its peak gain is 4.6 dBi:

<b>Part Number</b>
ML-2452-HPA5-036

#### 12.6.3.1 Dipole Antenna Maximum Conducted Transmit Power Settings

The following is a transmit power table (EU domain) per dipole antenna in the 5 GHz band:

<b>20 MHZ CHANNEL</b>	<b>40 MHZ CHANNEL</b>	<b>LEGACY OFDM RATES (6,9,12,18,24,36,48,54 MBPS)</b>	<b>802.11n HT20 RATES (MCS 0 MCS 15)</b>	<b>802.11n HT40 RATES (MCS 0 MCS 15)</b>
36		10.0	10.0	
38	(36, 40)			11.0
40		10.0	10.0	
42		10.0	10.0	
44		10.5	10.5	
46	(44, 48)			12.5
48		10.5	10.5	
52				
54	(52, 56)			
56				
60				
62	(60, 64)			
64				
100				
102	(100, 104)			
104				
108				
112				
110	(108, 112)			
116				
118	(116, 120)			
120				
124				
126	(124, 128)			
128				

<b>20 MHZ CHANNEL</b>	<b>40 MHZ CHANNEL</b>	<b>LEGACY OFDM RATES (6,9,12,18,24,36,48,54 MBPS)</b>	<b>802.11n HT20 RATES (MCS 0 MCS 15)</b>	<b>802.11n HT40 RATES (MCS 0 MCS 15)</b>
132				
134	(132, 136)			
136				
140				
149				
151	(149, 153)			
153				
157				
159	(157, 161)			
161				
165				



## 12.6.4 High-Gain Antenna Model

The following is the RFS4011 high-gain antenna model for 5 GHz, its peak gain is 6.3 - 10dBi:

<b>Part Number</b>
ML-2452-PNA7-01R

### 12.6.4.1 High-Gain Antenna Transmit Power Settings

The following is a transmit power table (EU domain) per high-gain antenna in the 5 GHz band:

<b>20 MHZ CHANNEL</b>	<b>40 MHZ CHANNEL</b>	<b>LEGACY OFDM RATES (6,9,12,18,24,36,48,54 MBPS)</b>	<b>802.11n HT20 RATES (MCS 0 MCS 15)</b>	<b>802.11n HT40 RATES (MCS 0 MCS 15)</b>
36		8.5	8.5	
38	(36, 40)			9.5
40		8.5	8.5	
42		8.5	8.5	
44		8.5	8.5	
46	(44, 48)			10.0
48		9.0	9.0	
52				
54	(52, 56)			
56				
60				
62	(60, 64)			
64				
100				
102	(100, 104)			
104				
108				
112				
110	(108, 112)			
116				
118	(116, 120)			
120				
124				
126	(124, 128)			
128				

<b>20 MHZ CHANNEL</b>	<b>40 MHZ CHANNEL</b>	<b>LEGACY OFDM RATES (6,9,12,18,24,36,48,54 MBPS)</b>	<b>802.11n HT20 RATES (MCS 0 MCS 15)</b>	<b>802.11n HT40 RATES (MCS 0 MCS 15)</b>
132				
134	(132, 136)			
136				
140				
149				
151	(149, 153)			
153				
157				
159	(157, 161)			
161				
165				

## 12.7 Japan Regulatory Domain 2.4 GHz Band

### 12.7.1 Facade Antenna Model

The following is the RFS4011 facade antenna model for 2.4 GHz, the peak gain is 2.1dBi:

<i>Part Number</i>
ML-2452-PTA4M3X3-1

#### 12.7.1.1 Facade Antenna Maximum Conducted Transmit Power Settings

The following is a transmit power table (Japan domain) per facade antenna in the 2.4 GHz band:

<b>20 MHZ CHANNEL</b>	<b>40 MHZ CHANNEL</b>	<b>LEGACY DSSS RATES (1, 2, 5.5, 11 MBPS)</b>	<b>LEGACY OFDM RATES (6,9,12,18,24,36, 48,54 MBPS)</b>	<b>802.11n HT20 RATES (MCS 0 MCS 15)</b>	<b>802.11n HT40 RATES (MCS 0 MCS15)</b>
1		10.5	12.0	12.0	
2		10.5	11.5	11.5	
3	(1, 5)	10.5	11.5	11.5	13.5
4	(2, 6)	10.5	11.5	11.5	13.0
5	(3, 7)	10.5	11.5	11.5	13.0
6	(4, 8)	10.5	11.5	11.5	13.0
7	(5, 9)	10.5	11.5	11.5	13.0
8	(6, 10)	10.5	11.5	11.5	13.0
9	(7, 11)	10.5	11.5	11.5	13.0
10	(8, 10)	10.5	11.5	11.5	13.0
11	(9, 13)	10.5	11.5	11.5	13.0
12		10.5	11.5	11.5	
13		10.5	12.0	12.0	
14		12.5			

## 12.7.2 MIMO Patch Antenna Model

The following is the RFS4011 MIMO patch antenna model for 2.4 GHz, its peak gain is 3.5dBi:

<b>Part Number</b>
ML-2452-PTA3M3-036

### 12.7.2.1 MIMO Patch Antenna Maximum Conducted Transmit Power Settings

The following is a transmit power table (Japan domain) per MIMO patch antenna in the 2.4 GHz band:

<b>20 MHZ CHANNEL</b>	<b>40 MHZ CHANNEL</b>	<b>LEGACY DSSS RATES (1, 2, 5.5, 11 MBPS)</b>	<b>LEGACY OFDM RATES (6,9,12,18,24,36, 48,54 MBPS)</b>	<b>802.11n HT20 RATES (MCS 0 MCS 15)</b>	<b>802.11n HT40 RATES (MCS 0 MCS15)</b>
1		10.5	12.0	12.0	
2		10.5	11.5	11.5	
3	(1, 5)	10.5	11.5	11.5	13.5
4	(2, 6)	10.5	11.5	11.5	13.0
5	(3, 7)	10.5	11.5	11.5	13.0
6	(4, 8)	10.5	11.5	11.5	13.0
7	(5, 9)	10.5	11.5	11.5	13.0
8	(6, 10)	10.5	11.5	11.5	13.0
9	(7, 11)	10.5	11.5	11.5	13.0
10	(8, 10)	10.5	11.5	11.5	13.0
11	(9, 13)	10.5	11.5	11.5	13.0
12		10.5	11.5	11.5	
13		10.5	12.0	12.0	
14		12.5			

### 12.7.3 Dipole Antenna Model

The following is the RFS4011 dipole antenna model for 2.4 GHz, its peak gain is 3.1dBi:

<b>Part Number</b>
ML-2452-HPA5-036

#### 12.7.3.1 Dipole Antenna Maximum Conducted Transmit Power Settings

The following is a transmit power table (Japan domain) per dipole antenna in the 2.4 GHz band:

<b>20 MHZ CHANNEL</b>	<b>40 MHZ CHANNEL</b>	<b>LEGACY DSSS RATES (1, 2, 5.5, 11 MBPS)</b>	<b>LEGACY OFDM RATES (6,9,12,18,24,36, 48,54 MBPS)</b>	<b>802.11n HT20 RATES (MCS 0 MCS 15)</b>	<b>802.11n HT40 RATES (MCS 0 MCS15)</b>
1		12.5	14.0	14.0	
2		12.0	13.5	13.5	
3	(1, 5)	12.0	13.5	13.5	15.0
4	(2, 6)	12.0	13.5	13.5	15.0
5	(3, 7)	12.0	13.5	13.5	15.0
6	(4, 8)	12.0	13.5	13.5	15.0
7	(5, 9)	12.0	13.5	13.5	15.0
8	(6, 10)	12.0	13.5	13.5	15.0
9	(7, 11)	12.0	13.5	13.5	15.0
10	(8, 10)	12.0	13.5	13.5	15.0
11	(9, 13)	12.0	13.5	13.5	15.0
12		12.0	13.5	13.5	
13		12.5	14.0	14.0	
14		14.5			

### 12.7.4 High-Gain Antenna Model

The following is the RFS4011 high-gain antenna model for 2.4 GHz, its peak gain is 7.5dBi:

<b>Part Number</b>
ML-2452-PNA7-01R

#### 12.7.4.1 High-Gain Antenna Maximum Conducted Transmit Power Settings

The following is a transmit power table (Japan domain) per high-gain antenna in the 2.4 GHz band:

<b>20 MHZ CHANNEL</b>	<b>40 MHZ CHANNEL</b>	<b>LEGACY DSSS RATES (1, 2, 5.5, 11 MBPS)</b>	<b>LEGACY OFDM RATES (6,9,12,18,24,36, 48,54 MBPS)</b>	<b>802.11n HT20 RATES (MCS 0 MCS 15)</b>	<b>802.11n HT40 RATES (MCS0 MCS15)</b>
1		8.0	9.0	9.0	
2		8.0	9.0	9.0	
3	(1, 5)	8.0	9.0	9.0	14.5
4	(2, 6)	8.0	9.0	9.0	14.0
5	(3, 7)	8.0	9.0	9.0	14.0
6	(4, 8)	8.0	9.0	9.0	14.0
7	(5, 9)	8.0	9.0	9.0	14.0
8	(6, 10)	8.0	9.0	9.0	14.0
9	(7, 11)	8.0	9.0	9.0	14.0
10	(8, 10)	8.0	9.0	9.0	14.0
11	(9, 13)	8.0	9.0	9.0	14.0
12		8.0	9.0	9.0	
13		8.0	9.5	9.5	
14		10.0			

## 12.8 Japan Regulatory Domain 5 GHz Band

### 12.8.1 Facade Antenna Model

The following is the RFS4011 facade antenna model for 5 GHz, its peak gain is 3.95dBi:

<b>Part Number</b>
ML-2452-PTA4M3X3-1

#### 12.8.1.1 Facade Antenna Maximum Conducted Transmit Power Settings

The following is a transmit power table (Japan domain) per facade antenna in the 5 GHz band:

<b>20 MHZ CHANNEL</b>	<b>40 MHZ CHANNEL</b>	<b>LEGACY OFDM RATES (6,9,12,18,24,36,48,54 MBPS)</b>	<b>802.11n HT20 RATES (MCS 0 MCS 15)</b>	<b>802.11n HT40 RATES (MCS 0 MCS 15)</b>
36		10.5	11.0	
38	(36, 40)			11.5
40		10.0	10.5	
42		9.5	10.0	
44		9.5	10.0	
46	(44, 48)			11.0
48		9.5	10.0	
52				
54	(52, 56)			
56				
60				
62	(60, 64)			
64				
100				
102	(100, 104)			
104				
108				
112				
110	(108, 112)			
116				
118	(116, 120)			
120				
124				

<b>20 MHZ CHANNEL</b>	<b>40 MHZ CHANNEL</b>	<b>LEGACY OFDM RATES (6,9,12,18,24,36,48,54 MBPS)</b>	<b>802.11n HT20 RATES (MCS 0 MCS 15)</b>	<b>802.11n HT40 RATES (MCS 0 MCS 15)</b>
126	(124, 128)			
128				
132				
134	(132, 136)			
136				
140				
149				
151	(149, 153)			
153				
157				
159	(157, 161)			
161				
165				



## 12.8.2 MIMO Patch Antenna Model

The following is the RFS4011 MIMO patch antenna model for 5 GHz, its peak gain is 5dBi:

<b>Part Number</b>
ML-2452-PTA3M3-036

### 12.8.2.1 MIMO Patch Antenna Maximum Conducted Transmit Power Settings

The following is a transmit power table (Japan domain) per MIMO patch antenna in the 5 GHz band:

<b>20 MHZ CHANNEL</b>	<b>40 MHZ CHANNEL</b>	<b>LEGACY OFDM RATES (6,9,12,18,24,36,48,54 MBPS)</b>	<b>802.11n HT20 RATES (MCS 0 MCS 15)</b>	<b>802.11n HT40 RATES (MCS 0 MCS 15)</b>
36		9.0	9.5	
38	(36,40)			10.5
40		9.0	9.5	
42		8.5	9.0	
44		8.5	9.0	
46	(44,48)			10.5
48		8.5	9.0	
52				
54	(52,56)			
56				
60				
62	(60,64)			
64				
100				
102	(100,104)			
104				
108				
112				
110	(108,112)			
116				
118	(116,120)			
120				
124				
126	(124,128)			
128				

<b>20 MHZ CHANNEL</b>	<b>40 MHZ CHANNEL</b>	<b>LEGACY OFDM RATES (6,9,12,18,24,36,48,54 MBPS)</b>	<b>802.11n HT20 RATES (MCS 0 MCS 15)</b>	<b>802.11n HT40 RATES (MCS 0 MCS 15)</b>
132				
134	(132,136)			
136				
140				
149				
151	(149,153)			
153				
157				
159	(157,161)			
161				
165				

### 12.8.3 Dipole Model

The following is the RFS4011 dipole antenna model for 5 GHz, its peak gain is 4.6 dBi:

<b>Part Number</b>
ML-2452-HPA5-036

#### 12.8.3.1 Dipole Antenna Maximum Conducted Transmit Power Settings

The following is a transmit power table (Japan domain) per dipole antenna in the 5 GHz band:

<b>20 MHZ CHANNEL</b>	<b>40 MHZ CHANNEL</b>	<b>LEGACY OFDM RATES (6,9,12,18,24,36,48,54 MBPS)</b>	<b>802.11n HT20 RATES (MCS 0 MCS 15)</b>	<b>802.11n HT40 RATES (MCS 0 MCS 15)</b>
36		10.0	10.5	
38	(36, 40)			11.0
40		9.5	10.0	
42		9.0	9.5	
44		9.0	9.5	
46	(44, 48)			10.5
48		9.0	9.5	
52				
54	(52, 56)			
56				
60				
62	(60, 64)			
64				
100				
102	(100, 104)			
104				
108				
112				
110	(108, 112)			
116				
118	(116, 120)			
120				
124				
126	(124, 128)			
128				

<b>20 MHZ CHANNEL</b>	<b>40 MHZ CHANNEL</b>	<b>LEGACY OFDM RATES (6,9,12,18,24,36,48,54 MBPS)</b>	<b>802.11n HT20 RATES (MCS 0 MCS 15)</b>	<b>802.11n HT40 RATES (MCS 0 MCS 15)</b>
132				
134	(132, 136)			
136				
140				
149				
151	(149, 153)			
153				
157				
159	(157, 161)			
161				
165				

## 12.8.4 High-Gain Antenna Model

The following is the RFS4011 high-gain antenna model for 5 GHz, its peak gain is 6.3 - 10dBi:

<b>Part Number</b>
ML-2452-PNA7-01R

### 12.8.4.1 High-Gain Antenna Transmit Power Settings

The following is a transmit power table (Japan domain) per high-gain antenna in the 5 GHz band:

<b>20 MHZ CHANNEL</b>	<b>40 MHZ CHANNEL</b>	<b>LEGACY OFDM RATES (6,9,12,18,24,36,48,54 MBPS)</b>	<b>802.11n HT20 RATES (MCS 0 MCS 15)</b>	<b>802.11n HT40 RATES (MCS 0 MCS 15)</b>
36		8.0	8.5	
38	(36, 40)			9.5
40		8.0	8.5	
42		7.5	8.0	
44		7.5	8.0	
46	(44, 48)			9.5
48		7.5	0.0	
52				
54	(52, 56)			
56				
60				
62	(60, 64)			
64				
100				
102	(100, 104)			
104				
108				
112				
110	(108, 112)			
116				
118	(116, 120)			
120				
124				
126	(124, 128)			
128				

<b>20 MHZ CHANNEL</b>	<b>40 MHZ CHANNEL</b>	<b>LEGACY OFDM RATES (6,9,12,18,24,36,48,54 MBPS)</b>	<b>802.11n HT20 RATES (MCS 0 MCS 15)</b>	<b>802.11n HT40 RATES (MCS 0 MCS 15)</b>
132				
134	(132, 136)			
136				
140				
149				
151	(149, 153)			
153				
157				
159	(157, 161)			
161				
165				

# 13

## ***AP-6511 Regulatory Domains***

The AP-6511 model Access Point contains two internal (embedded) dual-band antennas supporting both the 802.11bgn (2.4 GHz) and 802.11an (5.0 GHz) bands. No customer assembly or antenna orientation is required.

The AP-6511 radio can transmit on one or two antennas depending on the operating modes. The radio can receive on one or two antennas as well. The data rates supported are different in each case.

- 2.4 GHz Internal Antenna Peak Gain - 2dBi
- 5 GHz Internal Antenna Peak Gain - 4.5dBi

### **13.1 US Regulatory Domain 2.4 GHz Band**

The following is a transmit power table (US domain) per antenna in the 2.4 GHz band:

<b>20 MHZ CHANNEL</b>	<b>40 MHZ CHANNEL</b>	<b>LEGACY DSSS RATES (1, 2, 5.5, 11 MBPS)</b>	<b>LEGACY OFDM RATES (6,9,12,18,24,36, 48,54 MBPS)</b>	<b>802.11n HT20 RATES (MCS 0 MCS 15)</b>	<b>802.11n HT40 RATES (MCS 0 MCS15)</b>
1		23	17	18	
2		24	18	18	
3	(1, 5)	24	18	18	14
4	(2, 6)	24	18	18	16
5	(3, 7)	24	18	18	17
6	(4, 8)	24	18	18	16
7	(5, 9)	24	18	18	16
8	(6, 10)	24	18	18	17
9	(7, 11)	24	18	18	15
10		24	18	18	
11		23	18	17	

## 13.2 US Regulatory Domain 5 GHz Band

The following is a transmit power table (US domain) per antenna in the 5 GHz band:

<b>20 MHZ CHANNEL</b>	<b>40 MHZ CHANNEL</b>	<b>LEGACY OFDM RATES (6,9,12,18,24,36,48,54 MBPS)</b>	<b>802.11n HT20 RATES (MCS 0 MCS 15)</b>	<b>802.11n HT40 RATES (MCS 0 MCS 15)</b>
36		13	14	
38	(36, 40)	13	14	14
40		13	14	
42		13	14	
44		13	14	
46	(44, 48)	13	14	14
48		13	14	
52		20	20	
54	(52, 56)	20	20	21
56		20	20	
60		20	20	
62	(60, 64)	20	20	13
64		18	16	
100		20	20	
102	(100, 104)	20	20	21
104		20	20	
108		20	20	
112		20	20	
110	(108, 112)	20	20	21
116		20	20	
118	(116, 120)	20	20	21
120		20	20	
124		20	20	
126	(124, 128)	20	20	21
128		20	20	
132		20	20	
134	(132, 136)	20	20	21
136		20	20	
140		20	20	
149		20	20	



<b>20 MHZ CHANNEL</b>	<b>40 MHZ CHANNEL</b>	<b>LEGACY OFDM RATES (6,9,12,18,24,36,48,54 MBPS)</b>	<b>802.11n HT20 RATES (MCS 0 MCS 15)</b>	<b>802.11n HT40 RATES (MCS 0 MCS 15)</b>
151	(149, 153)	20	20	21
153		20	20	
157		20	20	
159	(157, 161)	20	20	21
161		20	20	
165		20	20	

### 13.3 EU Regulatory Domain 2.4 GHz Band

The following is a transmit power table (EU domain) per antenna in the 2.4 GHz band:

<b>20 MHZ CHANNEL</b>	<b>40 MHZ CHANNEL</b>	<b>LEGACY DSSS RATES (1, 2, 5.5, 11 MBPS)</b>	<b>LEGACY OFDM RATES (6,9,12,18,24,36, 48,54 MBPS)</b>	<b>802.11n HT20 RATES (MCS 0 MCS 15)</b>	<b>802.11n HT40 RATES (MCS 0 MCS15)</b>
1		15	15	15	
2		15	15	15	
3	(1, 5)	15	15	15	15
4	(2, 6)	15	15	15	15
5	(3, 7)	15	15	15	15
6	(4, 8)	15	15	15	15
7	(5, 9)	15	15	15	15
8	(6, 10)	15	15	15	15
9	(7, 11)	15	15	15	15
10	(8, 12)	15	15	15	15
11	(9, 13)	15	15	15	15
12		15	15	15	
13		15	15	15	
14					

## 13.4 EU Regulatory Domain 5 GHz Band

The following is a transmit power table (EU domain) per antenna in the 5 GHz band:

<b>20 MHZ CHANNEL</b>	<b>40 MHZ CHANNEL</b>	<b>LEGACY OFDM RATES (6,9,12,18,24,36,48,54 MBPS)</b>	<b>802.11n HT20 RATES (MCS 0 MCS 15)</b>	<b>802.11n HT40 RATES (MCS 0 MCS 15)</b>
36		14	14	
38	(36, 40)	14	14	14
40		14	14	
42		14	14	
44		14	14	
46	(44, 48)	14	14	14
48		14	14	
52		14	14	
54	(52, 56)	14	14	14
56		14	14	
60		14	14	
62	(60, 64)	14	14	14
64		14	14	
100		20	20	
102	(100, 104)	20	20	20
104		20	20	
108		20	20	
112		20	20	
110	(108, 112)	20	20	20
116		20	20	
118	(116, 120)	20	20	20
120		20	20	
124		20	20	
126	(124, 128)	20	20	20
128		20	20	
132		20	20	
134	(132, 136)	20	20	20
136		20	20	
140		20	20	
149		20	20	

<b>20 MHZ CHANNEL</b>	<b>40 MHZ CHANNEL</b>	<b>LEGACY OFDM RATES (6,9,12,18,24,36,48,54 MBPS)</b>	<b>802.11n HT20 RATES (MCS 0 MCS 15)</b>	<b>802.11n HT40 RATES (MCS 0 MCS 15)</b>
151	(149, 153)	20	20	20
153		20	20	
157		20	20	
159	(157, 161)	20	20	20
161		20	20	
165		20	20	

## 13.5 Japan Regulatory Domain 2.4 GHz Band

The following is a transmit power table (Japan domain) per antenna in the 2.4 GHz band:

<b>20 MHZ CHANNEL</b>	<b>40 MHZ CHANNEL</b>	<b>LEGACY DSSS RATES (1, 2, 5.5, 11 MBPS)</b>	<b>LEGACY OFDM RATES (6,9,12,18,24,36, 48,54 MBPS)</b>	<b>802.11n HT20 RATES (MCS 0 MCS 15)</b>	<b>802.11n HT40 RATES (MCS 0 MCS15)</b>
1		12	12	14	
2		12	12	14	
3	(1, 5)	12	12	14	11
4	(2, 6)	12	12	14	11
5	(3, 7)	12	12	14	11
6	(4, 8)	12	12	14	11
7	(5, 9)	12	12	14	11
8	(6, 10)	12	12	14	11
9	(7, 11)	12	12	14	11
10	(8, 12)	12	12	14	11
11	(9, 13)	12	12	14	11
12		12	12	14	
13		12	12	14	
14		14			

## 13.6 Japan Regulatory Domain 5 GHz Band

The following is a transmit power table (Japan domain) per antenna in the 5 GHz band:

<b>20 MHZ CHANNEL</b>	<b>40 MHZ CHANNEL</b>	<b>LEGACY OFDM RATES (6,9,12,18,24,36,48,54 MBPS)</b>	<b>802.11n HT20 RATES (MCS 0 MCS 15)</b>	<b>802.11n HT40 RATES (MCS 0 MCS 15)</b>
36		7	9	
38	(36, 40)	7	9	10
40		7	9	
42		7	9	
44		7	9	
46	(44, 48)	7	9	10
48		7	9	
52		7	9	
54	(52, 56)	7	9	10
56		7	9	
60		7	9	
62	(60, 64)	7	9	10
64		7	9	
100		11	12	
102	(100, 104)	11	12	11
104		11	12	
108		11	12	
112		11	12	
110	(108, 112)	11	12	11
116		11	12	
118	(116, 120)	11	12	11
120		11	12	
124		11	12	
126	(124, 128)	11	12	11
128		11	12	
132		11	12	
134	(132, 136)	11	12	11
136		11	12	
140		11	12	
149				

<b>20 MHZ CHANNEL</b>	<b>40 MHZ CHANNEL</b>	<b>LEGACY OFDM RATES (6,9,12,18,24,36,48,54 MBPS)</b>	<b>802.11n HT20 RATES (MCS 0 MCS 15)</b>	<b>802.11n HT40 RATES (MCS 0 MCS 15)</b>
151	(149, 153)			
153				
157				
159	(157, 161)			
161				
165				

## AP-621 and AP-6521 Regulatory Domains

This chapter describes standard and high power transmission capabilities for AP-621 and AP-6521 access points in both the 2.4 and 5GHz radio bands. The information is provided for the US, EU and Japan regulatory domains. AP-621 and AP-6521 access points support 802.11a/b/g/n in both standard and high power SKUs.

### 14.1 AP-621 (Standard Power) US Regulatory Domain 2.4GHz Band

The following are standard power transmit tables (US domain) per listed antenna in the 2.4GHz band:

#### 14.1.1 Internal Antenna Model

The following is an AP-621 standard transmit power table (US domain) per Internal antenna in the 2.4GHz band:

<b>20 MHZ CHANNEL</b>	<b>40 MHZ CHANNEL</b>	<b>LEGACY DSSS RATES (1, 2, 5.5, 11 MBPS)</b>	<b>LEGACY OFDM RATES (6,9,12,18,24,36, 48,54 MBPS)</b>	<b>802.11n HT20 RATES (MCS 0 MCS 15)</b>	<b>802.11n HT40 RATES (MCS 0 MCS15)</b>
1		19	14	14	
2		19	15	15	
3	(1, 5)	19	15	15	10
4	(2, 6)	19	15	15	12
5	(3, 7)	19	15	15	14
6	(4, 8)	23	15	15	14
7	(5, 9)	21	15	15	14
8	(6, 10)	21	15	15	14
9	(7, 11)	21	15	15	14
10	(8, 12)	21	15	15	
11	(9, 13)	21	15	15	

Internal antenna, peak gain = 3dBi

### 14.1.2 Dipole Antenna Model

The following is an AP-621 standard transmit power table (US domain) per Dipole antenna in the 2.4GHz band:

<b>20 MHZ CHANNEL</b>	<b>40 MHZ CHANNEL</b>	<b>LEGACY DSSS RATES (1, 2, 5.5, 11 MBPS)</b>	<b>LEGACY OFDM RATES (6,9,12,18,24,36, 48,54 MBPS)</b>	<b>802.11n HT20 RATES (MCS 0 MCS 15)</b>	<b>802.11n HT40 RATES (MCS 0 MCS15)</b>
1		18	12	11	
2		18	13	13	
3	(1, 5)	20.5	13	13.5	7.5
4	(2, 6)	20.5	13	13.5	9
5	(3, 7)	20.5	13	13.5	10.5
6	(4, 8)	20.5	13	13.5	12
7	(5, 9)	20.5	13	13.5	10.5
8	(6, 10)	20.5	13	13.5	9
9	(7, 11)	17	13	13.5	6
10	(8, 12)	17	10.5	10.5	
11	(9, 13)	16.5	10.5	10.5	

Dipole antenna, peak gain = 10.5dBi



**14.1.3 Panel Antenna Model**

The following is an AP-621 standard transmit power table (US domain) per Panel antenna in the 2.4GHz band:

<b>20 MHZ CHANNEL</b>	<b>40 MHZ CHANNEL</b>	<b>LEGACY DSSS RATES (1, 2, 5.5, 11 MBPS)</b>	<b>LEGACY OFDM RATES (6,9,12,18,24,36, 48,54 MBPS)</b>	<b>802.11n HT20 RATES (MCS 0 MCS 15)</b>	<b>802.11n HT40 RATES (MCS 0 MCS15)</b>
1		19	12	12	
2		19	12	12	
3	(1, 5)	24	18	18	6
4	(2, 6)	24	18	18	10
5	(3, 7)	24	18	18	13
6	(4, 8)	24	18	18	14
7	(5, 9)	24	18	18	14
8	(6, 10)	24	18	18	14
9	(7, 11)	24	18	18	12
10	(8, 12)	23	14	14	11
11	(9, 13)	22	14	14	6

Panel antenna, peak gain = 4.5dBi

### 14.1.4 Patch Antenna Model

The following is an AP-621 standard transmit power table (US domain) per Patch antenna in the 2.4GHz band:

<b>20 MHZ CHANNEL</b>	<b>40 MHZ CHANNEL</b>	<b>LEGACY DSSS RATES (1, 2, 5.5, 11 MBPS)</b>	<b>LEGACY OFDM RATES (6,9,12,18,24,36, 48,54 MBPS)</b>	<b>802.11n HT20 RATES (MCS 0 MCS 15)</b>	<b>802.11n HT40 RATES (MCS 0 MCS15)</b>
1		18	12.5	11	
2		18	15.5	16	
3	(1, 5)	22.5	16	16	7
4	(2, 6)	22.5	16	16	9
5	(3, 7)	22.5	16	16	10.5
6	(4, 8)	22.5	16	16	9
7	(5, 9)	22.5	16	16	10.5
8	(6, 10)	22.5	16	16	7.5
9	(7, 11)	22.5	16	16	4.5
10	(8, 12)	17	10	9.5	
11	(9, 13)	17	10	9.5	

Patch antenna, peak gain = 7.5dBi

## 14.2 AP-621 (Standard Power) US Regulatory Domain 5GHz Band

The following are standard power transmit tables (US domain) per listed antenna in the 5GHz band:

### 14.2.1 Internal Dipole Antenna Maximum Conducted Transmit Power Settings

The following is an AP-621 standard transmit power table (US domain) per Internal Dipole antenna in the 5GHz band:

<b>20 MHZ CHANNEL</b>	<b>40 MHZ CHANNEL</b>	<b>LEGACY OFDM RATES (6,9,12,18,24,36,48,54 MBPS)</b>	<b>802.11n HT20 RATES (MCS 0 MCS 15)</b>	<b>802.11n HT40 RATES (MCS 0 MCS 15)</b>
36		12	14	
38	(36, 40)	12	14	14
40		12	14	
42		12	14	
44		12	14	
46	(44, 48)	12	14	14
48		12	14	
52		20	20	
54	(52, 56)	20	20	20
56		20	20	
60		20	20	
62	(60, 64)	20	20	20
64		20	20	
100		15	15	
102	(100, 104)	15	15	11
104		20	20	
108		20	20	
112		20	20	
110	(108, 112)	20	20	20
116		20	20	
118	(116, 120)	20	20	20
120		20	20	
124		20	20	
126	(124, 128)	20	20	20
128		20	20	
132		20	20	
134	(132, 136)	20	14	15
136		20	20	

<b>20 MHZ CHANNEL</b>	<b>40 MHZ CHANNEL</b>	<b>LEGACY OFDM RATES (6,9,12,18,24,36,48,54 MBPS)</b>	<b>802.11n HT20 RATES (MCS 0 MCS 15)</b>	<b>802.11n HT40 RATES (MCS 0 MCS 15)</b>
140		14	14	
149		20	20	
151	(149, 153)	20	20	20
153		20	16	
157		20	20	
159	(157, 161)	20	20	20
161		20	20	
165		20	20	

Internal Dipole antenna with peak gain = 6dBi

## 14.2.2 External Dipole Antenna Maximum Conducted Transmit Power Settings

The following is an AP-621 standard transmit power table (US domain) per External Dipole antenna in the 5GHz band:

<b>20 MHZ CHANNEL</b>	<b>40 MHZ CHANNEL</b>	<b>LEGACY OFDM RATES (6,9,12,18,24,36,48,54 MBPS)</b>	<b>802.11n HT20 RATES (MCS 0 MCS 15)</b>	<b>802.11n HT40 RATES (MCS 0 MCS 15)</b>
36		11	12	
38	(36, 40)	11	12	12
40		11	12	
42		11	12	
44		11	12	
46	(44, 48)	11	12	12
48		11	12	
52		20	18	
54	(52, 56)	20	20	14
56		20	20	
60		20	20	
62	(60, 64)	20	20	14
64		17	18	
100		12	12	
102	(100, 104)	15	15	9
104		20	20	
108		20	20	
112		20	20	
110	(108, 112)	20	20	19
116		20	20	
118	(116, 120)	20	20	19
120		20	20	
124		20	20	
126	(124, 128)	20	20	20
128		20	20	
132		20	20	
134	(132, 136)	15	15	15
136		20	20	
140		14	13	
149		20	20	
151	(149, 153)	20	20	20

<b>20 MHZ CHANNEL</b>	<b>40 MHZ CHANNEL</b>	<b>LEGACY OFDM RATES (6,9,12,18,24,36,48,54 MBPS)</b>	<b>802.11n HT20 RATES (MCS 0 MCS 15)</b>	<b>802.11n HT40 RATES (MCS 0 MCS 15)</b>
153		20	20	
157		20	20	
159	(157, 161)	20	20	20
161		20	20	
165		20	20	

External Dipole antenna with peak gain = 5dBi

### 14.2.3 External Panel Antenna Maximum Conducted Transmit Power Settings

The following is an AP-621 standard transmit power table (US domain) per External Panel antenna in the 5GHz band:

<b>20 MHZ CHANNEL</b>	<b>40 MHZ CHANNEL</b>	<b>LEGACY OFDM RATES (6,9,12,18,24,36,48,54 MBPS)</b>	<b>802.11n HT20 RATES (MCS 0 MCS 15)</b>	<b>802.11n HT40 RATES (MCS 0 MCS 15)</b>
36		11	12	
38	(36, 40)	11	12	12
40		11	12	
42		11	12	
44		11	12	
46	(44, 48)	11	12	12
48		11	12	
52		20	16	
54	(52, 56)	20	20	14
56		22	20	
60		20	18	
62	(60, 64)	20	20	13
64		17	19	
100		12	20	
102	(100, 104)	20	20	9
104		20	20	
108		20	20	
112		20	20	
110	(108, 112)	20	11	16
116		17	19	
118	(116, 120)	20	20	20
120		20	20	
124		20	20	
126	(124, 128)	20	20	20
128		20	20	
132		20	20	
134	(132, 136)	20	20	14
136		20	20	
140		15	13	
149		20	20	
151	(149, 153)	20	20	20

<b>20 MHZ CHANNEL</b>	<b>40 MHZ CHANNEL</b>	<b>LEGACY OFDM RATES (6,9,12,18,24,36,48,54 MBPS)</b>	<b>802.11n HT20 RATES (MCS 0 MCS 15)</b>	<b>802.11n HT40 RATES (MCS 0 MCS 15)</b>
153		20	20	
157		20	20	
159	(157, 161)	20	20	20
161		20	20	
165		20	20	

External Panel antenna with peak gain = 5dBi



### 14.2.4 External Patch Antenna Maximum Conducted Transmit Power Settings

The following is an AP-621 standard transmit power table (US domain) per External Patch antenna in the 5GHz band:

<b>20 MHZ CHANNEL</b>	<b>40 MHZ CHANNEL</b>	<b>LEGACY OFDM RATES (6,9,12,18,24,36,48,54 MBPS)</b>	<b>802.11n HT20 RATES (MCS 0 MCS 15)</b>	<b>802.11n HT40 RATES (MCS 0 MCS 15)</b>
36		11.5	12.5	
38	(36, 40)	11.5	13	12.5
40		11.5	13	
42		11.5	13	
44		11.5	13	
46	(44, 48)	11.5	13	13
48		11.5	13	
52		18.5	19.5	
54	(52, 56)	19	19.5	19.5
56		19	19.5	
60		19	19.5	
62	(60, 64)	19	19.5	13.5
64		19	19.5	
100		16	15.5	
102	(100, 104)	19	19	12
104		19	19	
108		19	19	
112		19	19	
110	(108, 112)	19	19	19
116		19	19	
118	(116, 120)	19	19	19
120		19	19	
124		19	19	
126	(124, 128)	19	19	19
128		19	19	
132		19	19	
134	(132, 136)	19	19	15
136		19	19	
140		16	16	
149		18	18	

<b>20 MHZ CHANNEL</b>	<b>40 MHZ CHANNEL</b>	<b>LEGACY OFDM RATES (6,9,12,18,24,36,48,54 MBPS)</b>	<b>802.11n HT20 RATES (MCS 0 MCS 15)</b>	<b>802.11n HT40 RATES (MCS 0 MCS 15)</b>
151	(149, 153)	18.5	18.5	18.5
153		18.5	18.5	
157		18.5	18.5	
159	(157, 161)	18.5	18.5	18.5
161		18.5	18.5	
165		18.5	18.5	

External Patch antenna with peak gain = 5dBi

## 14.3 AP-6521 (High Power) US Regulatory Domain 2.4GHz Band

The following are high power transmit tables (US domain) per listed antenna in the 2.4GHz band:

### 14.3.1 Internal Antenna Model

The following is an AP-6521 high transmit power table (US domain) per Internal antenna in the 2.4GHz band:

<b>20 MHZ CHANNEL</b>	<b>40 MHZ CHANNEL</b>	<b>LEGACY DSSS RATES (1, 2, 5.5, 11 MBPS)</b>	<b>LEGACY OFDM RATES (6,9,12,18,24,36, 48,54 MBPS)</b>	<b>802.11n HT20 RATES (MCS 0 MCS 15)</b>	<b>802.11n HT40 RATES (MCS 0 MCS15)</b>
1		19	14	14	
2		19	15	15	
3	(1, 5)	19	15	15	10
4	(2, 6)	19	15	15	12
5	(3, 7)	19	15	15	14
6	(4, 8)	23	15	15	14
7	(5, 9)	21	15	15	14
8	(6, 10)	21	15	15	14
9	(7, 11)	21	15	15	14
10	(8, 12)	21	15	15	
11	(9, 13)	21	15	15	

Internal antenna, peak gain = 3dBi

### 14.3.2 Dipole Antenna Model

The following is an AP-6521 high transmit power table (US domain) per Dipole antenna in the 2.4GHz band:

<b>20 MHZ CHANNEL</b>	<b>40 MHZ CHANNEL</b>	<b>LEGACY DSSS RATES (1, 2, 5.5, 11 MBPS)</b>	<b>LEGACY OFDM RATES (6,9,12,18,24,36, 48,54 MBPS)</b>	<b>802.11n HT20 RATES (MCS 0 MCS 15)</b>	<b>802.11n HT40 RATES (MCS 0 MCS15)</b>
1		18	12	11	
2		18	13	13	
3	(1, 5)	20.5	13	13.5	7.5
4	(2, 6)	20.5	13	13.5	9
5	(3, 7)	20.5	13	13.5	10.5
6	(4, 8)	20.5	13	13.5	12
7	(5, 9)	20.5	13	13.5	10.5
8	(6, 10)	20.5	13	13.5	9
9	(7, 11)	17	13	13.5	6
10	(8, 12)	17	10.5	10.5	
11	(9, 13)	16.5	10.5	10.5	

Dipole antenna, peak gain = 10.5dBi

### 14.3.3 Panel Antenna Model

The following is an AP-6521 high transmit power table (US domain) per Panel antenna in the 2.4GHz band:

<b>20 MHZ CHANNEL</b>	<b>40 MHZ CHANNEL</b>	<b>LEGACY DSSS RATES (1, 2, 5.5, 11 MBPS)</b>	<b>LEGACY OFDM RATES (6,9,12,18,24,36, 48,54 MBPS)</b>	<b>802.11n HT20 RATES (MCS 0 MCS 15)</b>	<b>802.11n HT40 RATES (MCS 0 MCS15)</b>
1		19	12	12	
2		19	12	12	
3	(1, 5)	24	18	18	6
4	(2, 6)	24	18	18	10
5	(3, 7)	24	18	18	13
6	(4, 8)	24	18	18	14
7	(5, 9)	24	18	18	14
8	(6, 10)	24	18	18	14
9	(7, 11)	24	18	18	12
10	(8, 12)	23	14	14	11
11	(9, 13)	22	14	14	6

Panel antenna, peak gain = 4.5dBi

### 14.3.4 Patch Antenna Model

The following is an AP-6521 high transmit power table (US domain) per Patch antenna in the 2.4GHz band:

<b>20 MHZ CHANNEL</b>	<b>40 MHZ CHANNEL</b>	<b>LEGACY DSSS RATES (1, 2, 5.5, 11 MBPS)</b>	<b>LEGACY OFDM RATES (6,9,12,18,24,36, 48,54 MBPS)</b>	<b>802.11n HT20 RATES (MCS 0 MCS 15)</b>	<b>802.11n HT40 RATES (MCS 0 MCS15)</b>
1		18	12.5	11	
2		18	15.5	16	
3	(1, 5)	22.5	16	16	7
4	(2, 6)	22.5	16	16	9
5	(3, 7)	22.5	16	16	10.5
6	(4, 8)	22.5	16	16	13
7	(5, 9)	22.5	16	16	10.5
8	(6, 10)	22.5	16	16	7.5
9	(7, 11)	22.5	16	16	4.5
10	(8, 12)	17	10	9.5	
11	(9, 13)	17	10	9.5	

Patch antenna, peak gain = 7.5dBi

## 14.4 AP-6521 (High Power) US Regulatory Domain 5GHz Band

The following are high power transmit tables (US domain) per listed antenna in the 5GHz band:

### 14.4.1 Internal Antenna Maximum Conducted Transmit Power Settings

The following is an AP-6521 high transmit power table (US domain) per Internal antenna in the 5GHz band:

<b>20 MHZ CHANNEL</b>	<b>40 MHZ CHANNEL</b>	<b>LEGACY OFDM RATES (6,9,12,18,24,36,48,54 MBPS)</b>	<b>802.11n HT20 RATES (MCS 0 MCS 15)</b>	<b>802.11n HT40 RATES (MCS 0 MCS 15)</b>
36		12	14	
38	(36, 40)	12	14	14
40		12	14	
42		12	14	
44		12	14	
46	(44, 48)	12	14	14
48		12	14	
52		20	20	
54	(52, 56)	20	20	20
56		20	20	
60		20	20	
62	(60, 64)	20	20	20
64		20	20	
100		14	14	
102	(100, 104)	15	15	10
104		20	20	
108		20	20	
112		20	20	
110	(108, 112)	20	20	20
116		20	20	
118	(116, 120)	20	20	20
120		20	20	
124		20	20	
126	(124, 128)	20	20	20
128		20	20	
132		20	20	
134	(132, 136)	20	14	14

<b>20 MHZ CHANNEL</b>	<b>40 MHZ CHANNEL</b>	<b>LEGACY OFDM RATES (6,9,12,18,24,36,48,54 MBPS)</b>	<b>802.11n HT20 RATES (MCS 0 MCS 15)</b>	<b>802.11n HT40 RATES (MCS 0 MCS 15)</b>
136		20	20	
140		20	13	
149		20	20	
151	(149, 153)	20	20	20
153		20	20	
157		20	20	
159	(157, 161)	20	20	20
161		20	20	
165		20	20	

Internal antenna with peak gain = 6dBi



### 14.4.2 External Dipole Antenna Maximum Conducted Transmit Power Settings

The following is an AP-6521 high transmit power table (US domain) per External Dipole antenna in the 5GHz band:

<b>20 MHZ CHANNEL</b>	<b>40 MHZ CHANNEL</b>	<b>LEGACY OFDM RATES (6,9,12,18,24,36,48,54 MBPS)</b>	<b>802.11n HT20 RATES (MCS 0 MCS 15)</b>	<b>802.11n HT40 RATES (MCS 0 MCS 15)</b>
36		11	12	
38	(36, 40)	11	12	12
40		11	12	
42		11	12	
44		11	12	
46	(44, 48)	11	12	12
48		11	12	
52		20	18	
54	(52, 56)	20	20	14
56		20	20	
60		20	20	
62	(60, 64)	20	20	14
64		17	18	
100		12	12	
102	(100, 104)	15	15	9
104		21	20	
108		21	20	
112		21	20	
110	(108, 112)	21	20	19
116		21	20	
118	(116, 120)	21	20	20
120		21	20	
124		21	20	
126	(124, 128)	21	20	20
128		21	20	
132		21	20	
134	(132, 136)	15	15	15
136		20	20	
140		13	13	
149		20	20	

<b>20 MHZ CHANNEL</b>	<b>40 MHZ CHANNEL</b>	<b>LEGACY OFDM RATES (6,9,12,18,24,36,48,54 MBPS)</b>	<b>802.11n HT20 RATES (MCS 0 MCS 15)</b>	<b>802.11n HT40 RATES (MCS 0 MCS 15)</b>
151	(149, 153)	20	20	20
153		20	20	
157		20	20	
159	(157, 161)	20	20	20
161		20	20	
165		20	20	

External Dipole antenna with peak gain = 5dBi

### 14.4.3 External Panel Antenna Maximum Conducted Transmit Power Settings

The following is an AP-6521 high transmit power table (US domain) per External Panel antenna in the 5GHz band:

<b>20 MHZ CHANNEL</b>	<b>40 MHZ CHANNEL</b>	<b>LEGACY OFDM RATES (6,9,12,18,24,36,48,54 MBPS)</b>	<b>802.11n HT20 RATES (MCS 0 MCS 15)</b>	<b>802.11n HT40 RATES (MCS 0 MCS 15)</b>
36		11	12	
38	(36, 40)	11	12	12
40		11	12	
42		11	12	
44		11	12	
46	(44, 48)	11	12	12
48		11	12	
52		20	16	
54	(52, 56)	20	20	14
56		20	20	
60		20	18	
62	(60, 64)	20	20	13
64		17	19	
100		12	11	
102	(100, 104)	20	20	9
104		20	20	
108		20	20	
112		20	20	
110	(108, 112)	20	11	16
116		20	19	
118	(116, 120)	20	20	20
120		20	20	
124		20	20	
126	(124, 128)	20	20	20
128		20	20	
132		20	20	
134	(132, 136)	20	20	14
136		20	20	
140		14	13	
149		20	20	

<b>20 MHZ CHANNEL</b>	<b>40 MHZ CHANNEL</b>	<b>LEGACY OFDM RATES (6,9,12,18,24,36,48,54 MBPS)</b>	<b>802.11n HT20 RATES (MCS 0 MCS 15)</b>	<b>802.11n HT40 RATES (MCS 0 MCS 15)</b>
151	(149, 153)	20	20	20
153		20	20	
157		20	20	
159	(157, 161)	20	20	20
161		20	20	
165		20	20	

External Panel antenna with peak gain = 5dBi

### 14.4.4 External Patch Antenna Maximum Conducted Transmit Power Settings

The following is an AP-6521 high transmit power table (US domain) per External Patch antenna in the 5GHz band:

<b>20 MHZ CHANNEL</b>	<b>40 MHZ CHANNEL</b>	<b>LEGACY OFDM RATES (6,9,12,18,24,36,48,54 MBPS)</b>	<b>802.11n HT20 RATES (MCS 0 MCS 15)</b>	<b>802.11n HT40 RATES (MCS 0 MCS 15)</b>
36		11.5	12.5	
38	(36, 40)	11.5	13	12.5
40		11.5	13	
42		11.5	13	
44		11.5	13	
46	(44, 48)	11.5	13	13
48		11.5	13	
52		18.5	19.5	
54	(52, 56)	19	19.5	19.5
56		19	19.5	
60		19	19.5	
62	(60, 64)	19	19.5	13.5
64		19	19.5	
100		16	15.5	
102	(100, 104)	19	19	12
104		19	19	
108		19	19	
112		19	19	
110	(108, 112)	19	19	19
116		19	19	
118	(116, 120)	19	19	19
120		19	19	
124		19	19	
126	(124, 128)	19	19	19
128		19	19	
132		19	19	
134	(132, 136)	19	19	15
136		19	19	
140		16	16	
149		18	18	

<b>20 MHZ CHANNEL</b>	<b>40 MHZ CHANNEL</b>	<b>LEGACY OFDM RATES (6,9,12,18,24,36,48,54 MBPS)</b>	<b>802.11n HT20 RATES (MCS 0 MCS 15)</b>	<b>802.11n HT40 RATES (MCS 0 MCS 15)</b>
151	(149, 153)	18.5	18.5	18.5
153		18.5	18.5	
157		18.5	18.5	
159	(157, 161)	18.5	18.5	18.5
161		18.5	18.5	
165		18.5	18.5	

External Patch antenna with peak gain = 5dBi

## 14.5 AP-621 (Standard Power) EU Regulatory Domain 2.4GHz Band

The following are standard power transmit tables (EU domain) per listed antenna in the 2.4GHz band:

### 14.5.1 Internal Antenna Model

The following is an AP-621 standard transmit power table (EU domain) per Internal antenna in the 2.4GHz band:

<b>20 MHZ CHANNEL</b>	<b>40 MHZ CHANNEL</b>	<b>LEGACY DSSS RATES (1, 2, 5.5, 11 MBPS)</b>	<b>LEGACY OFDM RATES (6,9,12,18,24,36, 48,54 MBPS)</b>	<b>802.11n HT20 RATES (MCS 0 MCS 15)</b>	<b>802.11n HT40 RATES (MCS 0 MCS15)</b>
1		14	14	14	
2		14	14	14	
3	(1, 5)	14	14	14	14
4	(2, 6)	14	14	14	14
5	(3, 7)	14	14	14	14
6	(4, 8)	14	14	14	14
7	(5, 9)	14	14	14	14
8	(6, 10)	14	14	14	14
9	(7, 11)	14	14	14	14
10	(8, 12)	14	14	14	14
11	(9, 13)	14	14	14	14
12		14	14	14	
13		14	14	14	
14					

Internal antenna, peak gain = 3dBi

## 14.5.2 Dipole Antenna Model

The following is an AP-621 standard transmit power table (EU domain) per Dipole antenna in the 2.4GHz band:

<b>20 MHZ CHANNEL</b>	<b>40 MHZ CHANNEL</b>	<b>LEGACY DSSS RATES (1, 2, 5.5, 11 MBPS)</b>	<b>LEGACY OFDM RATES (6,9,12,18,24,36, 48,54 MBPS)</b>	<b>802.11n HT20 RATES (MCS 0 MCS 15)</b>	<b>802.11n HT40 RATES (MCS 0 MCS15)</b>
1		12	12	12	
2		12	12	12	
3	(1, 5)	12	12	12	12
4	(2, 6)	12	12	12	12
5	(3, 7)	12	12	12	12
6	(4, 8)	12	12	12	12
7	(5, 9)	12	12	12	12
8	(6, 10)	12	12	12	12
9	(7, 11)	12	12	12	12
10	(8, 12)	12	12	12	12
11	(9, 13)	12	12	12	12
12		12	12	12	
13		12	12	12	
14					

Dipole antenna, peak gain = 4.6dBi



### 14.5.3 Panel Antenna Model

The following is an AP-621 standard transmit power table (EU domain) per Panel antenna in the 2.4GHz band:

<b>20 MHZ CHANNEL</b>	<b>40 MHZ CHANNEL</b>	<b>LEGACY DSSS RATES (1, 2, 5.5, 11 MBPS)</b>	<b>LEGACY OFDM RATES (6,9,12,18,24,36, 48,54 MBPS)</b>	<b>802.11n HT20 RATES (MCS 0 MCS 15)</b>	<b>802.11n HT40 RATES (MCS 0 MCS15)</b>
1		12	12	12	
2		12	12	12	
3	(1, 5)	12	12	12	12
4	(2, 6)	12	12	12	12
5	(3, 7)	12	12	12	12
6	(4, 8)	12	12	12	12
7	(5, 9)	12	12	12	12
8	(6, 10)	12	12	12	12
9	(7, 11)	12	12	12	12
10	(8, 12)	12	12	12	12
11	(9, 13)	12	12	12	12
12		12	12	12	
13		12	12	12	
14					

Panel antenna, peak gain = 4.5dBi

### 14.5.4 Patch Antenna Model

The following is an AP-621 standard transmit power table (EU domain) per Patch antenna in the 2.4GHz band:

<b>20 MHZ CHANNEL</b>	<b>40 MHZ CHANNEL</b>	<b>LEGACY DSSS RATES (1, 2, 5.5, 11 MBPS)</b>	<b>LEGACY OFDM RATES (6,9,12,18,24,36, 48,54 MBPS)</b>	<b>802.11n HT20 RATES (MCS 0 MCS 15)</b>	<b>802.11n HT40 RATES (MCS 0 MCS15)</b>
1		14	14	14	
2		14	14	14	
3	(1, 5)	14	14	14	14
4	(2, 6)	14	14	14	14
5	(3, 7)	14	14	14	14
6	(4, 8)	14	14	14	14
7	(5, 9)	14	14	14	14
8	(6, 10)	14	14	14	14
9	(7, 11)	14	14	14	14
10	(8, 12)	14	14	14	14
11	(9, 13)	14	14	14	14
12		14	14	14	
13		14	14	14	
14					

Patch antenna, peak gain = 3dBi

## 14.6 AP-621 (Standard Power) EU Regulatory Domain 5GHz Band

The following are standard power transmit tables (EU domain) per listed antenna in the 5GHz band:

### 14.6.1 External Dipole Antenna Maximum Conducted Transmit Power Settings

The following is an AP-621 standard transmit power table (EU domain) per External Dipole antenna in the 5GHz band:

<b>20 MHZ CHANNEL</b>	<b>40 MHZ CHANNEL</b>	<b>LEGACY OFDM RATES (6,9,12,18,24,36,48,54 MBPS)</b>	<b>802.11n HT20 RATES (MCS 0 MCS 15)</b>	<b>802.11n HT40 RATES (MCS 0 MCS 15)</b>
36		15	15	
38	(36, 40)	15	15	15
40		15	15	
42		15	15	
44		15	15	
46	(44, 48)	15	15	15
48		15	15	
52		15	15	
54	(52, 56)	15	15	15
56		15	15	
60		15	15	
62	(60, 64)	15	15	15
64		15	15	
100		20	20	
102	(100, 104)	20	20	20
104		20	20	
108		20	20	
112		20	20	
110	(108, 112)	20	20	20
116		20	20	
118	(116, 120)	20	20	20
120		20	20	
124		20	20	
126	(124, 128)	20	20	20
128		20	20	
132		20	20	
134	(132, 136)	20	20	20

<b>20 MHZ CHANNEL</b>	<b>40 MHZ CHANNEL</b>	<b>LEGACY OFDM RATES (6,9,12,18,24,36,48,54 MBPS)</b>	<b>802.11n HT20 RATES (MCS 0 MCS 15)</b>	<b>802.11n HT40 RATES (MCS 0 MCS 15)</b>
136		20	20	
140		20	20	
149				
151	(149, 153)			
153				
157				
159	(157, 161)			
161				
165				

External Dipole antenna with peak gain = 5dBi

### 14.6.2 External Panel Antenna Maximum Conducted Transmit Power Settings

The following is an AP-621 standard transmit power table (EU domain) per External Panel antenna in the 5GHz band:

<b>20 MHZ CHANNEL</b>	<b>40 MHZ CHANNEL</b>	<b>LEGACY OFDM RATES (6,9,12,18,24,36,48,54 MBPS)</b>	<b>802.11n HT20 RATES (MCS 0 MCS 15)</b>	<b>802.11n HT40 RATES (MCS 0 MCS 15)</b>
36		14	14	
38	(36, 40)	14	14	15
40		14	14	
42		14	14	
44		14	14	
46	(44, 48)	14	14	15
48		14	14	
52		14	14	
54	(52, 56)	14	14	15
56		14	14	
60		14	14	
62	(60, 64)	14	14	15
64		14	14	
100		20	20	
102	(100, 104)	20	20	20
104		20	20	
108		20	20	
112		20	20	
110	(108, 112)	20	20	20
116		20	20	
118	(116, 120)	20	20	20
120		20	20	
124		20	20	
126	(124, 128)	20	20	20
128		20	20	
132		20	20	
134	(132, 136)	20	20	20
136		20	20	
140		20	20	
149				

<b>20 MHZ CHANNEL</b>	<b>40 MHZ CHANNEL</b>	<b>LEGACY OFDM RATES (6,9,12,18,24,36,48,54 MBPS)</b>	<b>802.11n HT20 RATES (MCS 0 MCS 15)</b>	<b>802.11n HT40 RATES (MCS 0 MCS 15)</b>
151	(149, 153)			
153				
157				
159	(157, 161)			
161				
165				

External Panel antenna with peak gain = 5dBi

### 14.6.3 External Patch Antenna Maximum Conducted Transmit Power Settings

The following is an AP-621 standard transmit power table (EU domain) per External Patch antenna in the 5GHz band:

<b>20 MHZ CHANNEL</b>	<b>40 MHZ CHANNEL</b>	<b>LEGACY OFDM RATES (6,9,12,18,24,36,48,54 MBPS)</b>	<b>802.11n HT20 RATES (MCS 0 MCS 15)</b>	<b>802.11n HT40 RATES (MCS 0 MCS 15)</b>
36		16	16	
38	(36, 40)	16	16	16
40		16	16	
42		16	16	
44		16	16	
46	(44, 48)	16	16	16
48		16	16	
52		16	16	
54	(52, 56)	16	16	16
56		16	16	
60		16	16	
62	(60, 64)	16	16	16
64		16	16	
100		20	20	
102	(100, 104)	20	20	20
104		20	20	
108		20	20	
112		20	20	
110	(108, 112)	20	20	20
116		20	20	
118	(116, 120)	20	20	20
120		20	20	
124		20	20	
126	(124, 128)	20	20	20
128		20	20	
132		20	20	
134	(132, 136)	20	20	20
136		20	20	
140		20	20	
149				

<b>20 MHZ CHANNEL</b>	<b>40 MHZ CHANNEL</b>	<b>LEGACY OFDM RATES (6,9,12,18,24,36,48,54 MBPS)</b>	<b>802.11n HT20 RATES (MCS 0 MCS 15)</b>	<b>802.11n HT40 RATES (MCS 0 MCS 15)</b>
151	(149, 153)			
153				
157				
159	(157, 161)			
161				
165				

External Patch antenna with peak gain = 4dBi



### 14.6.4 Internal Patch Antenna Maximum Conducted Transmit Power Settings

The following is an AP-621 standard transmit power table (EU domain) per Internal Patch antenna in the 5GHz band:

<b>20 MHZ CHANNEL</b>	<b>40 MHZ CHANNEL</b>	<b>LEGACY OFDM RATES (6,9,12,18,24,36,48,54 MBPS)</b>	<b>802.11n HT20 RATES (MCS 0 MCS 15)</b>	<b>802.11n HT40 RATES (MCS 0 MCS 15)</b>
36		12	12	
38	(36, 40)	13	13	16
40		13	13	
42		13	13	
44		13	13	
46	(44, 48)	13	13	16
48		13	13	
52		13	16	
54	(52, 56)	13	16	16
56		13	16	
60		13	16	
62	(60, 64)	13	16	16
64		13	16	
100		19	20	
102	(100, 104)	19	20	19
104		19	20	
108		19	20	
112		19	20	
110	(108, 112)	19	20	20
116		19	20	
118	(116, 120)	19	20	20
120		19	20	
124		19	20	
126	(124, 128)	19	20	
128		19	20	20
132		19	20	
134	(132, 136)	19	20	20
136		19	20	
140		19	20	
149				

<b>20 MHZ CHANNEL</b>	<b>40 MHZ CHANNEL</b>	<b>LEGACY OFDM RATES (6,9,12,18,24,36,48,54 MBPS)</b>	<b>802.11n HT20 RATES (MCS 0 MCS 15)</b>	<b>802.11n HT40 RATES (MCS 0 MCS 15)</b>
151	(149, 153)			
153				
157				
159	(157, 161)			
161				

Internal Patch antenna with peak gain = 6dBi

## 14.7 AP-6521 (High Power) EU Regulatory Domain 2.4GHz Band

The following are high power transmit tables (EU domain) per listed antenna in the 2.4GHz band:

### 14.7.1 Internal Antenna Model

The following is an AP-6521 high transmit power table (EU domain) per Internal antenna in the 2.4GHz band:

<b>20 MHZ CHANNEL</b>	<b>40 MHZ CHANNEL</b>	<b>LEGACY DSSS RATES (1, 2, 5.5, 11 MBPS)</b>	<b>LEGACY OFDM RATES (6,9,12,18,24,36, 48,54 MBPS)</b>	<b>802.11n HT20 RATES (MCS 0 MCS 15)</b>	<b>802.11n HT40 RATES (MCS 0 MCS15)</b>
1		14	14	14	
2		14	14	14	
3	(1, 5)	14	14	14	14
4	(2, 6)	14	14	14	14
5	(3, 7)	14	14	14	14
6	(4, 8)	14	14	14	14
7	(5, 9)	14	14	14	14
8	(6, 10)	14	14	14	14
9	(7, 11)	14	14	14	14
10	(8, 12)	14	14	14	14
11	(9, 13)	14	14	14	14
12		14	14	14	
13		14	14	14	
14					

Internal antenna, peak gain = 3dBi

### 14.7.2 Dipole Antenna Model

The following is an AP-6521 high transmit power table (EU domain) per Dipole antenna in the 2.4GHz band:

<b>20 MHZ CHANNEL</b>	<b>40 MHZ CHANNEL</b>	<b>LEGACY DSSS RATES (1, 2, 5.5, 11 MBPS)</b>	<b>LEGACY OFDM RATES (6,9,12,18,24,36, 48,54 MBPS)</b>	<b>802.11n HT20 RATES (MCS 0 MCS 15)</b>	<b>802.11n HT40 RATES (MCS 0 MCS15)</b>
1		12	12	12	
2		12	12	12	
3	(1, 5)	12	12	12	12
4	(2, 6)	12	12	12	12
5	(3, 7)	12	12	12	12
6	(4, 8)	12	12	12	12
7	(5, 9)	12	12	12	12
8	(6, 10)	12	12	12	12
9	(7, 11)	12	12	12	12
10	(8, 12)	12	12	12	12
11	(9, 13)	12	12	12	12
12		12	12	12	
13		12	12	12	
14					

Dipole antenna, peak gain = 4.6dBi

### 14.7.3 Panel Antenna Model

The following is an AP-6521 high transmit power table (EU domain) per Panel antenna in the 2.4GHz band:

<b>20 MHZ CHANNEL</b>	<b>40 MHZ CHANNEL</b>	<b>LEGACY DSSS RATES (1, 2, 5.5, 11 MBPS)</b>	<b>LEGACY OFDM RATES (6,9,12,18,24,36, 48,54 MBPS)</b>	<b>802.11n HT20 RATES (MCS 0 MCS 15)</b>	<b>802.11n HT40 RATES (MCS 0 MCS15)</b>
1		12	12	12	
2		12	12	12	
3	(1, 5)	12	12	12	12
4	(2, 6)	12	12	12	12
5	(3, 7)	12	12	12	12
6	(4, 8)	12	12	12	12
7	(5, 9)	12	12	12	12
8	(6, 10)	12	12	12	12
9	(7, 11)	12	12	12	12
10	(8, 12)	12	12	12	12
11	(9, 13)	12	12	12	12
12		12	12	12	
13		12	12	12	
14					

Panel antenna, peak gain = 4.5dBi

### 14.7.4 Patch Antenna Model

The following is an AP-6521 high transmit power table (EU domain) per Patch antenna in the 2.4GHz band:

<b>20 MHZ CHANNEL</b>	<b>40 MHZ CHANNEL</b>	<b>LEGACY DSSS RATES (1, 2, 5.5, 11 MBPS)</b>	<b>LEGACY OFDM RATES (6,9,12,18,24,36, 48,54 MBPS)</b>	<b>802.11n HT20 RATES (MCS 0 MCS 15)</b>	<b>802.11n HT40 RATES (MCS 0 MCS15)</b>
1		14	14	14	
2		14	14	14	
3	(1, 5)	14	14	14	14
4	(2, 6)	14	14	14	14
5	(3, 7)	14	14	14	14
6	(4, 8)	14	14	14	14
7	(5, 9)	14	14	14	14
8	(6, 10)	14	14	14	14
9	(7, 11)	14	14	14	14
10	(8, 12)	14	14	14	14
11	(9, 13)	14	14	14	14
12		14	14	14	
13		14	14	14	
14					

Patch antenna, peak gain = 3dBi

## 14.8 AP-6521 (High Power) EU Regulatory Domain 5GHz Band

The following are high power transmit tables (EU domain) per listed antenna in the 5GHz band:

### 14.8.1 Internal Antenna Maximum Conducted Transmit Power Settings

The following is an AP-6521 high transmit power table (EU domain) per Internal antenna in the 5GHz band:

<b>20 MHZ CHANNEL</b>	<b>40 MHZ CHANNEL</b>	<b>LEGACY OFDM RATES (6,9,12,18,24,36,48,54 MBPS)</b>	<b>802.11n HT20 RATES (MCS 0 MCS 15)</b>	<b>802.11n HT40 RATES (MCS 0 MCS 15)</b>
36		15	14	
38	(36, 40)	15	14	14
40		15	14	
42		15	14	
44		15	14	
46	(44, 48)	15	14	14
48		15	14	
52		15	14	
54	(52, 56)	15	14	14
56		15	14	
60		15	14	
62	(60, 64)	15	14	14
64		15	14	
100		22	22	
102	(100, 104)	22	22	22
104		22	22	
108		22	22	
112		22	22	
110	(108, 112)	22	22	22
116		22	22	
118	(116, 120)	22	22	22
120		22	22	
124		22	22	
126	(124, 128)	22	22	22
128		22	22	
132		22	22	
134	(132, 136)	22	22	22

<b>20 MHZ CHANNEL</b>	<b>40 MHZ CHANNEL</b>	<b>LEGACY OFDM RATES (6,9,12,18,24,36,48,54 MBPS)</b>	<b>802.11n HT20 RATES (MCS 0 MCS 15)</b>	<b>802.11n HT40 RATES (MCS 0 MCS 15)</b>
136		20	20	
140		20	20	
149				
151	(149, 153)			
153				
157				
159	(157, 161)			
161				
165				

Internal antenna with peak gain = 6dBi



### 14.8.2 External Dipole Antenna Maximum Conducted Transmit Power Settings

The following is an AP-6521 high transmit power table (EU domain) per External Dipole antenna in the 5GHz band:

<b>20 MHZ CHANNEL</b>	<b>40 MHZ CHANNEL</b>	<b>LEGACY OFDM RATES (6,9,12,18,24,36,48,54 MBPS)</b>	<b>802.11n HT20 RATES (MCS 0 MCS 15)</b>	<b>802.11n HT40 RATES (MCS 0 MCS 15)</b>
36		15	15	
38	(36, 40)	15	15	15
40		15	15	
42		15	15	
44		15	15	
46	(44, 48)	15	15	15
48		15	15	
52		15	15	
54	(52, 56)	15	15	15
56		15	15	
60		15	15	
62	(60, 64)	15	15	15
64		15	15	
100		22	22	
102	(100, 104)	22	22	22
104		22	22	
108		22	22	
112		22	22	
110	(108, 112)	22	22	22
116		22	22	
118	(116, 120)	22	22	22
120		22	22	
124		22	22	
126	(124, 128)	22	22	22
128		22	22	
132		22	22	
134	(132, 136)	22	22	22
136		22	22	
140		22	22	
149				

<b>20 MHZ CHANNEL</b>	<b>40 MHZ CHANNEL</b>	<b>LEGACY OFDM RATES (6,9,12,18,24,36,48,54 MBPS)</b>	<b>802.11n HT20 RATES (MCS 0 MCS 15)</b>	<b>802.11n HT40 RATES (MCS 0 MCS 15)</b>
151	(149, 153)			
153				
157				
159	(157, 161)			
161				
165				

External Dipole antenna with peak gain = 5dBi

### 14.8.3 External Panel Antenna Maximum Conducted Transmit Power Settings

The following is an AP-6521 high transmit power table (EU domain) per External Panel antenna in the 5GHz band:

<b>20 MHZ CHANNEL</b>	<b>40 MHZ CHANNEL</b>	<b>LEGACY OFDM RATES (6,9,12,18,24,36,48,54 MBPS)</b>	<b>802.11n HT20 RATES (MCS 0 MCS 15)</b>	<b>802.11n HT40 RATES (MCS 0 MCS 15)</b>
36		15	15	
38	(36, 40)	15	15	15
40		15	15	
42		15	15	
44		15	15	
46	(44, 48)	15	15	15
48		15	15	
52		22	22	
54	(52, 56)	22	22	22
56		22	22	
60		22	22	
62	(60, 64)	22	22	22
64		22	22	
100		22	22	
102	(100, 104)	22	22	22
104		22	22	
108		22	22	
112		22	22	
110	(108, 112)	22	22	22
116		22	22	
118	(116, 120)	22	22	22
120		22	22	
124		22	22	
126	(124, 128)	22	22	22
128		22	22	
132		22	22	
134	(132, 136)	22	22	22
136		22	22	
140		22	22	
149				

<b>20 MHZ CHANNEL</b>	<b>40 MHZ CHANNEL</b>	<b>LEGACY OFDM RATES (6,9,12,18,24,36,48,54 MBPS)</b>	<b>802.11n HT20 RATES (MCS 0 MCS 15)</b>	<b>802.11n HT40 RATES (MCS 0 MCS 15)</b>
151	(149, 153)			
153				
157				
159	(157, 161)			
161				
165				

External Panel antenna with peak gain = 5dBi

### 14.8.4 External Patch Antenna Maximum Conducted Transmit Power Settings

The following is an AP-6521 high transmit power table (EU domain) per External Patch antenna in the 5GHz band:

<b>20 MHZ CHANNEL</b>	<b>40 MHZ CHANNEL</b>	<b>LEGACY OFDM RATES (6,9,12,18,24,36,48,54 MBPS)</b>	<b>802.11n HT20 RATES (MCS 0 MCS 15)</b>	<b>802.11n HT40 RATES (MCS 0 MCS 15)</b>
36		16	16	
38	(36, 40)	16	16	16
40		16	16	
42		16	16	
44		16	16	
46	(44, 48)	16	16	16
48		16	16	
52		16	16	
54	(52, 56)	16	16	16
56		16	16	
60		16	16	
62	(60, 64)	16	16	16
64		16	16	
100		22	22	
102	(100, 104)	22	22	22
104		22	22	
108		22	22	
112		22	22	
110	(108, 112)	22	22	22
116		22	22	
118	(116, 120)	22	22	22
120		22	22	
124		22	22	
126	(124, 128)	22	22	22
128		22	22	
132		22	22	
134	(132, 136)	22	22	22
136		22	22	
140		22	22	
149				

<b>20 MHZ CHANNEL</b>	<b>40 MHZ CHANNEL</b>	<b>LEGACY OFDM RATES (6,9,12,18,24,36,48,54 MBPS)</b>	<b>802.11n HT20 RATES (MCS 0 MCS 15)</b>	<b>802.11n HT40 RATES (MCS 0 MCS 15)</b>
151	(149, 153)			
153				
157				
159	(157, 161)			
161				
165				

External Patch antenna with peak gain = 4dBi

## 14.9 AP-621 (Standard Power) Japan Regulatory Domain 2.4GHz Band

The following are standard power transmit tables (Japan domain) per listed antenna in the 2.4GHz band:

### 14.9.1 Dipole (Dual-Band) or Outdoor Omni Dipole Antenna Model

The following is an AP-621 standard transmit power table (Japan domain) per dipole (dual-band) or outdoor omni dipole antenna in the 2.4GHz band:

<b>20 MHZ CHANNEL</b>	<b>40 MHZ CHANNEL</b>	<b>LEGACY DSSS RATES (1, 2, 5.5, 11 MBPS)</b>	<b>LEGACY OFDM RATES (6,9,12,18,24,36, 48,54 MBPS)</b>	<b>802.11n HT20 RATES (MCS 0 MCS 15)</b>	<b>802.11n HT40 RATES (MCS 0 MCS15)</b>
1		17	19	19	
2		17	19	19	
3	(1, 5)	17	19	19	22
4	(2, 6)	17	19	19	22
5	(3, 7)	17	19	19	22
6	(4, 8)	17	19	19	22
7	(5, 9)	17	19	19	22
8	(6, 10)	17	19	19	22
9	(7, 11)	17	19	19	22
10	(8, 12)	17	19	19	22
11	(9, 13)	17	19	19	22
12		17	19	19	
13		17	19	19	
14					

Dipole (dual-band) or outdoor omni dipole antenna with peak gain = 3dBi

### 14.9.2 Internal (Dual-Band) Antenna Model

The following is an AP-621 standard transmit power table (Japan domain) per internal (dual-band) antenna in the 2.4GHz band:

<b>20 MHZ CHANNEL</b>	<b>40 MHZ CHANNEL</b>	<b>LEGACY DSSS RATES (1, 2, 5.5, 11 MBPS)</b>	<b>LEGACY OFDM RATES (6,9,12,18,24,36, 48,54 MBPS)</b>	<b>802.11n HT20 RATES (MCS 0 MCS 15)</b>	<b>802.11n HT40 RATES (MCS 0 MCS15)</b>
1		17	19	19	
2		17	19	19	
3	(1, 5)	17	19	19	22
4	(2, 6)	17	19	19	22
5	(3, 7)	17	19	19	22
6	(4, 8)	17	19	19	22
7	(5, 9)	17	19	19	22
8	(6, 10)	17	19	19	22
9	(7, 11)	17	19	19	22
10	(8, 12)	17	19	19	22
11	(9, 13)	17	19	19	22
12		17	19	19	
13		17	19	19	
14					

Internal (dual-band) antenna with peak gain = 3dBi



### 14.9.3 Panel Antenna Model

The following is an AP-621 standard transmit power table (Japan domain) per panel antenna in the 2.4GHz band:

<b>20 MHZ CHANNEL</b>	<b>40 MHZ CHANNEL</b>	<b>LEGACY DSSS RATES (1, 2, 5.5, 11 MBPS)</b>	<b>LEGACY OFDM RATES (6,9,12,18,24,36, 48,54 MBPS)</b>	<b>802.11n HT20 RATES (MCS 0 MCS 15)</b>	<b>802.11n HT40 RATES (MCS 0 MCS15)</b>
1		16	17	17	
2		16	19	17	
3	(1, 5)	16	17	17	20
4	(2, 6)	16	17	17	20
5	(3, 7)	16	17	17	20
6	(4, 8)	16	17	17	20
7	(5, 9)	16	17	17	20
8	(6, 10)	16	17	17	20
9	(7, 11)	16	17	17	20
10	(8, 12)	16	17	17	20
11	(9, 13)	16	17	17	20
12		16	17	17	
13		16	17	17	
14					

Panel antenna with peak gain = 4.5dBi

### 14.9.4 Patch Antenna Model

The following is an AP-621 standard transmit power table (Japan domain) per patch antenna in the 2.4GHz band:

<b>20 MHZ CHANNEL</b>	<b>40 MHZ CHANNEL</b>	<b>LEGACY DSSS RATES (1, 2, 5.5, 11 MBPS)</b>	<b>LEGACY OFDM RATES (6,9,12,18,24,36, 48,54 MBPS)</b>	<b>802.11n HT20 RATES (MCS 0 MCS 15)</b>	<b>802.11n HT40 RATES (MCS 0 MCS15)</b>
1		17	19	19	
2		17	19	19	
3	(1, 5)	17	19	19	22
4	(2, 6)	17	19	19	22
5	(3, 7)	17	19	19	22
6	(4, 8)	17	19	19	22
7	(5, 9)	17	19	19	22
8	(6, 10)	17	19	19	22
9	(7, 11)	17	19	19	22
10	(8, 12)	17	19	19	22
11	(9, 13)	17	19	19	22
12		17	19	19	
13		17	19	19	
14					

Patch antenna with peak gain = 5dBi

## 14.10 AP-621 (Standard Power) Japan Regulatory Domain 5GHz Band

The following are AP-621 standard power tables (Japan domain) per listed antenna in the 5GHz band:

### 14.10.1 Dipole (Dual-Band) or Outdoor Omni Dipole Antenna Model Maximum Conducted Transmit Power Settings

The following is an AP-621 standard transmit power table (Japan domain) per dipole (dual-band) or outdoor omni dipole antenna in the 5GHz band:

<b>20 MHZ CHANNEL</b>	<b>40 MHZ CHANNEL</b>	<b>LEGACY OFDM RATES (6,9,12,18,24,36,48,54 MBPS)</b>	<b>802.11n HT20 RATES (MCS 0 MCS 15)</b>	<b>802.11n HT40 RATES (MCS 0 MCS 15)</b>
36		10.0	12.5	
38	(36, 40)	12.5	12.5	12.5
40		12.5	12.5	
42		12.5	12.5	
44		12.5	12.5	
46	(44, 48)	12.5	12.5	12.5
48		12.5	12.5	
52		12.5	12.5	
54	(52, 56)	12.5	12.5	12.5
56		12.5	12.5	
60		12.5	12.5	
62	(60, 64)	12.5	12.5	12.5
64		12.5	12.5	
100		18.0	18.0	
102	(100, 104)	18.0	18.0	18.0
104		18.0	18.0	
108		18.0	18.0	
112		18.0	18.0	
110	(108, 112)	18.0	18.0	18.0
116		18.0	18.0	
118	(116, 120)	18.0	18.0	18.0
120		18.0	18.0	
124		18.0	18.0	
126	(124, 128)	18.0	18.0	18.0
128		18.0	18.0	
132		18.0	18.0	

<b>20 MHZ CHANNEL</b>	<b>40 MHZ CHANNEL</b>	<b>LEGACY OFDM RATES (6,9,12,18,24,36,48,54 MBPS)</b>	<b>802.11n HT20 RATES (MCS 0 MCS 15)</b>	<b>802.11n HT40 RATES (MCS 0 MCS 15)</b>
134	(132, 136)	18.0	18.0	18.0
136		18.0	18.0	
140		18.0	18.0	
149				
151	(149, 153)			
153				
157				
159	(157, 161)			
161				
165				

Dipole (dual-band) or outdoor omni dipole antenna with peak gain = 5dBi

### 14.10.2 Internal (Dual-Band) Antenna Model Maximum Conducted Transmit Power Settings

The following is an AP-621 standard transmit power table (Japan domain) per internal (dual-band) antenna in the 5GHz band:

<b>20 MHZ CHANNEL</b>	<b>40 MHZ CHANNEL</b>	<b>LEGACY OFDM RATES (6,9,12,18,24,36,48,54 MBPS)</b>	<b>802.11n HT20 RATES (MCS 0 MCS 15)</b>	<b>802.11n HT40 RATES (MCS 0 MCS 15)</b>
36		11.5	11.5	
38	(36, 40)	11.5	11.5	11.5
40		11.5	11.5	
42		11.5	11.5	
44		11.5	11.5	
46	(44, 48)	11.5	11.5	11.5
48		11.5	11.5	
52		11.5	11.5	
54	(52, 56)	11.5	11.5	11.5
56		11.5	11.5	
60		11.5	11.5	
62	(60, 64)	11.5	11.5	11.5
64		11.5	11.5	
100		17.0	17.0	
102	(100, 104)	17.0	17.0	17.0
104		17.0	17.0	
108		17.0	17.0	
112		17.0	17.0	
110	(108, 112)	17.0	17.0	17.0
116		17.0	17.0	
118	(116, 120)	17.0	17.0	17.0
120		17.0	17.0	
124		17.0	17.0	
126	(124, 128)	17.0	17.0	17.0
128		17.0	17.0	
132		17.0	17.0	
134	(132, 136)	17.0	17.0	17.0
136		17.0	17.0	
140		17.0	17.0	

<b>20 MHZ CHANNEL</b>	<b>40 MHZ CHANNEL</b>	<b>LEGACY OFDM RATES (6,9,12,18,24,36,48,54 MBPS)</b>	<b>802.11n HT20 RATES (MCS 0 MCS 15)</b>	<b>802.11n HT40 RATES (MCS 0 MCS 15)</b>
149				
151	(149, 153)			
153				
157				
159	(157, 161)			
161				
165				

Internal (dual-band) antenna with peak gain = 6dBi

### 14.10.3 Panel Antenna Model Maximum Conducted Transmit Power Settings

The following is an AP-621 standard transmit power table (Japan domain) per panel antenna in the 5GHz band:

<b>20 MHZ CHANNEL</b>	<b>40 MHZ CHANNEL</b>	<b>LEGACY OFDM RATES (6,9,12,18,24,36,48,54 MBPS)</b>	<b>802.11n HT20 RATES (MCS 0 MCS 15)</b>	<b>802.11n HT40 RATES (MCS 0 MCS 15)</b>
36		12.5	12.5	
38	(36, 40)	12.5	12.5	12.5
40		12.5	12.5	
42		12.5	12.5	
44		12.5	12.5	
46	(44, 48)	12.5	12.5	12.5
48		12.5	12.5	
52		12.5	12.5	
54	(52, 56)	12.5	12.5	12.5
56		12.5	12.5	
60		12.5	12.5	
62	(60, 64)	12.5	12.5	12.5
64		12.5	12.5	
100		18.0	18.0	
102	(100, 104)	18.0	18.0	18.0
104		18.0	18.0	
108		18.0	18.0	
112		18.0	18.0	
110	(108, 112)	18.0	18.0	18.0
116		18.0	18.0	
118	(116, 120)	18.0	18.0	18.0
120		18.0	18.0	
124		18.0	18.0	
126	(124, 128)	18.0	18.0	18.0
128		18.0	18.0	
132		18.0	18.0	
134	(132, 136)	18.0	18.0	18.0
136		18.0	18.0	
140		18.0	18.0	
149				

<b>20 MHZ CHANNEL</b>	<b>40 MHZ CHANNEL</b>	<b>LEGACY OFDM RATES (6,9,12,18,24,36,48,54 MBPS)</b>	<b>802.11n HT20 RATES (MCS 0 MCS 15)</b>	<b>802.11n HT40 RATES (MCS 0 MCS 15)</b>
151	(149, 153)			
153				
157				
159	(157, 161)			
161				
165				

Panel antenna with peak gain = 5dBi



### 14.10.4 Patch Antenna Model Maximum Conducted Transmit Power Settings

The following is an AP-621 standard transmit power table (Japan domain) per patch antenna in the 5GHz band:

<b>20 MHZ CHANNEL</b>	<b>40 MHZ CHANNEL</b>	<b>LEGACY OFDM RATES (6,9,12,18,24,36,48,54 MBPS)</b>	<b>802.11n HT20 RATES (MCS 0 MCS 15)</b>	<b>802.11n HT40 RATES (MCS 0 MCS 15)</b>
36		13.5	13.5	
38	(36, 40)	13.5	13.5	13.5
40		13.5	13.5	
42		13.5	13.5	
44		13.5	13.5	
46	(44, 48)	13.5	13.5	12.5
48		13.5	13.5	
52		13.5	13.5	
54	(52, 56)	13.5	13.5	13.5
56		13.5	13.5	
60		13.5	13.5	
62	(60, 64)	13.5	13.5	13.5
64		13.5	13.5	
100		19.0	19.0	
102	(100, 104)	19.0	19.0	19.0
104		19.0	19.0	
108		19.0	19.0	
112		19.0	19.0	
110	(108, 112)	19.0	19.0	19.0
116		19.0	19.0	
118	(116, 120)	19.0	19.0	19.0
120		19.0	19.0	
124		19.0	19.0	
126	(124, 128)	19.0	19.0	19.0
128		19.0	19.0	
132		19.0	19.0	
134	(132, 136)	19.0	19.0	19.0
136		19.0	19.0	
140		19.0	19.0	
149				

<b>20 MHZ CHANNEL</b>	<b>40 MHZ CHANNEL</b>	<b>LEGACY OFDM RATES (6,9,12,18,24,36,48,54 MBPS)</b>	<b>802.11n HT20 RATES (MCS 0 MCS 15)</b>	<b>802.11n HT40 RATES (MCS 0 MCS 15)</b>
151	(149, 153)			
153				
157				
159	(157, 161)			
161				
165				

Patch antenna with peak gain = 4dBi

## 14.11 AP-6521 (High Power) Japan Regulatory Domain 2.4GHz Band

The following are AP-6521 high power transmit tables (Japan domain) per listed antenna in the 2.4GHz band:

### 14.11.1 Dipole (Dual-Band) or Outdoor Omni Dipole Antenna Model

The following is an AP-6521 high transmit power table (Japan domain) per dipole (dual-band) or outdoor omni dipole antenna in the 2.4GHz band:

<b>20 MHZ CHANNEL</b>	<b>40 MHZ CHANNEL</b>	<b>LEGACY DSSS RATES (1, 2, 5.5, 11 MBPS)</b>	<b>LEGACY OFDM RATES (6,9,12,18,24,36, 48,54 MBPS)</b>	<b>802.11n HT20 RATES (MCS 0 MCS 15)</b>	<b>802.11n HT40 RATES (MCS 0 MCS15)</b>
1		17	19	19	
2		17	19	19	
3	(1, 5)	17	19	19	22
4	(2, 6)	17	19	19	22
5	(3, 7)	17	19	19	22
6	(4, 8)	17	19	19	22
7	(5, 9)	17	19	19	22
8	(6, 10)	17	19	19	22
9	(7, 11)	17	19	19	22
10	(8, 12)	17	19	19	22
11	(9, 13)	17	19	19	22
12		17	19	19	
13		17	19	19	
14					

Dipole (dual-band) or outdoor omni dipole antenna with peak gain = 3dBi

### 14.11.2 Internal (Dual-Band) Antenna Model

The following is an AP-6521 high transmit power table (Japan domain) per internal (dual-band) antenna in the 2.4GHz band:

<b>20 MHZ CHANNEL</b>	<b>40 MHZ CHANNEL</b>	<b>LEGACY DSSS RATES (1, 2, 5.5, 11 MBPS)</b>	<b>LEGACY OFDM RATES (6,9,12,18,24,36, 48,54 MBPS)</b>	<b>802.11n HT20 RATES (MCS 0 MCS 15)</b>	<b>802.11n HT40 RATES (MCS 0 MCS15)</b>
1		17	19	19	
2		17	19	19	
3	(1, 5)	17	19	19	22
4	(2, 6)	17	19	19	22
5	(3, 7)	17	19	19	22
6	(4, 8)	17	19	19	22
7	(5, 9)	17	19	19	22
8	(6, 10)	17	19	19	22
9	(7, 11)	17	19	19	22
10	(8, 12)	17	19	19	22
11	(9, 13)	17	19	19	22
12		17	19	19	
13		17	19	19	
14					

Internal (dual-band) antenna with peak gain = 3dBi

### 14.11.3 Panel Antenna Model

The following is an AP-6521 high transmit power table (Japan domain) per panel antenna in the 2.4GHz band:

<b>20 MHZ CHANNEL</b>	<b>40 MHZ CHANNEL</b>	<b>LEGACY DSSS RATES (1, 2, 5.5, 11 MBPS)</b>	<b>LEGACY OFDM RATES (6,9,12,18,24,36, 48,54 MBPS)</b>	<b>802.11n HT20 RATES (MCS 0 MCS 15)</b>	<b>802.11n HT40 RATES (MCS 0 MCS15)</b>
1		16	17	17	
2		16	17	17	
3	(1, 5)	16	17	17	20
4	(2, 6)	16	17	17	20
5	(3, 7)	16	17	17	20
6	(4, 8)	16	17	17	20
7	(5, 9)	16	17	17	20
8	(6, 10)	16	17	17	20
9	(7, 11)	16	17	17	20
10	(8, 12)	16	17	17	20
11	(9, 13)	16	17	17	20
12		16	17	17	
13		16	17	17	
14					

Panel antenna with peak gain = 4.5dBi

### 14.11.4 Patch Antenna Model

The following is an AP-6521 high transmit power table (Japan domain) per patch antenna in the 2.4GHz band:

<b>20 MHZ CHANNEL</b>	<b>40 MHZ CHANNEL</b>	<b>LEGACY DSSS RATES (1, 2, 5.5, 11 MBPS)</b>	<b>LEGACY OFDM RATES (6,9,12,18,24,36, 48,54 MBPS)</b>	<b>802.11n HT20 RATES (MCS 0 MCS 15)</b>	<b>802.11n HT40 RATES (MCS 0 MCS15)</b>
1		17	19	19	
2		17	19	19	
3	(1, 5)	17	19	19	22
4	(2, 6)	17	19	19	22
5	(3, 7)	17	19	19	22
6	(4, 8)	17	19	19	22
7	(5, 9)	17	19	19	22
8	(6, 10)	17	19	19	22
9	(7, 11)	17	19	19	22
10	(8, 12)	17	19	19	22
11	(9, 13)	17	19	19	22
12		17	19	19	
13		17	19	19	
14					

Patch antenna with peak gain = 3dBi

## 14.12 AP-6521 (High Power) Japan Regulatory Domain 5GHz Band

The following are AP-6521 high power tables (Japan domain) per listed antenna in the 5GHz band:

### 14.12.1 Dipole (Dual-Band) or Outdoor Omni Dipole Antenna Model Maximum Conducted Transmit Power Settings

The following is an AP-6521 high transmit power table (Japan domain) per dipole (dual-band) or outdoor omni dipole antenna in the 5GHz band:

<b>20 MHZ CHANNEL</b>	<b>40 MHZ CHANNEL</b>	<b>LEGACY OFDM RATES (6,9,12,18,24,36,48,54 MBPS)</b>	<b>802.11n HT20 RATES (MCS 0 MCS 15)</b>	<b>802.11n HT40 RATES (MCS 0 MCS 15)</b>
36		10.0	12.5	
38	(36, 40)	12.5	12.5	12.5
40		12.5	12.5	
42		12.5	12.5	
44		12.5	12.5	
46	(44, 48)	12.5	12.5	12.5
48		12.5	12.5	
52		12.5	12.5	
54	(52, 56)	12.5	12.5	12.5
56		12.5	12.5	
60		12.5	12.5	
62	(60, 64)	12.5	12.5	12.5
64		12.5	12.5	
100		18.0	18.0	
102	(100, 104)	18.0	18.0	18.0
104		18.0	18.0	
108		18.0	18.0	
112		18.0	18.0	
110	(108, 112)	18.0	18.0	18.0
116		18.0	18.0	
118	(116, 120)	18.0	18.0	18.0
120		18.0	18.0	
124		18.0	18.0	
126	(124, 128)	18.0	18.0	18.0
128		18.0	18.0	
132		18.0	18.0	

<b>20 MHZ CHANNEL</b>	<b>40 MHZ CHANNEL</b>	<b>LEGACY OFDM RATES (6,9,12,18,24,36,48,54 MBPS)</b>	<b>802.11n HT20 RATES (MCS 0 MCS 15)</b>	<b>802.11n HT40 RATES (MCS 0 MCS 15)</b>
134	(132, 136)	18.0	18.0	18.0
136		18.0	18.0	
140		18.0	18.0	
149				
151	(149, 153)			
153				
157				
159	(157, 161)			
161				
165				

Dipole (dual-band) or outdoor omni dipole antenna with peak gain = 5dBi



### 14.12.2 Internal (Dual-Band) Antenna Model Maximum Conducted Transmit Power Settings

The following is an AP-6521 high transmit power table (Japan domain) per internal (dual-band) antenna in the 5GHz band:

<b>20 MHZ CHANNEL</b>	<b>40 MHZ CHANNEL</b>	<b>LEGACY OFDM RATES (6,9,12,18,24,36,48,54 MBPS)</b>	<b>802.11n HT20 RATES (MCS 0 MCS 15)</b>	<b>802.11n HT40 RATES (MCS 0 MCS 15)</b>
36		11.5	11.5	
38	(36, 40)	11.5	11.5	11.5
40		11.5	11.5	
42		11.5	11.5	
44		11.5	11.5	
46	(44, 48)	11.5	11.5	11.5
48		11.5	11.5	
52		11.5	11.5	
54	(52, 56)	11.5	11.5	11.5
56		11.5	11.5	
60		11.5	11.5	
62	(60, 64)	11.5	11.5	11.5
64		11.5	11.5	
100		17.0	17.0	
102	(100, 104)	17.0	17.0	17.0
104		17.0	17.0	
108		17.0	17.0	
112		17.0	17.0	
110	(108, 112)	17.0	17.0	17.0
116		17.0	17.0	
118	(116, 120)	17.0	17.0	17.0
120		17.0	17.0	
124		17.0	17.0	
126	(124, 128)	17.0	17.0	17.0
128		17.0	17.0	
132		17.0	17.0	
134	(132, 136)	17.0	17.0	17.0
136		17.0	17.0	
140		17.0	17.0	

<b>20 MHZ CHANNEL</b>	<b>40 MHZ CHANNEL</b>	<b>LEGACY OFDM RATES (6,9,12,18,24,36,48,54 MBPS)</b>	<b>802.11n HT20 RATES (MCS 0 MCS 15)</b>	<b>802.11n HT40 RATES (MCS 0 MCS 15)</b>
149				
151	(149, 153)			
153				
157				
159	(157, 161)			
161				
165				

Internal (dual-band) antenna with peak gain = 6dBi

### 14.12.3 Panel Antenna Model Maximum Conducted Transmit Power Settings

The following is an AP-6521 high transmit power table (Japan domain) per panel antenna in the 5GHz band:

<b>20 MHZ CHANNEL</b>	<b>40 MHZ CHANNEL</b>	<b>LEGACY OFDM RATES (6,9,12,18,24,36,48,54 MBPS)</b>	<b>802.11n HT20 RATES (MCS 0 MCS 15)</b>	<b>802.11n HT40 RATES (MCS 0 MCS 15)</b>
36		12.5	12.5	
38	(36, 40)	12.5	12.5	12.5
40		12.5	12.5	
42		12.5	12.5	
44		12.5	12.5	
46	(44, 48)	12.5	12.5	12.5
48		12.5	12.5	
52		12.5	12.5	
54	(52, 56)	12.5	12.5	12.5
56		12.5	12.5	
60		12.5	12.5	
62	(60, 64)	12.5	12.5	12.5
64		12.5	12.5	
100		18.0	18.0	
102	(100, 104)	18.0	18.0	18.0
104		18.0	18.0	
108		18.0	18.0	
112		18.0	18.0	
110	(108, 112)	18.0	18.0	18.0
116		18.0	18.0	
118	(116, 120)	18.0	18.0	18.0
120		18.0	18.0	
124		18.0	18.0	
126	(124, 128)	18.0	18.0	18.0
128		18.0	18.0	
132		18.0	18.0	
134	(132, 136)	18.0	18.0	18.0
136		18.0	18.0	
140		18.0	18.0	
149				

<b>20 MHZ CHANNEL</b>	<b>40 MHZ CHANNEL</b>	<b>LEGACY OFDM RATES (6,9,12,18,24,36,48,54 MBPS)</b>	<b>802.11n HT20 RATES (MCS 0 MCS 15)</b>	<b>802.11n HT40 RATES (MCS 0 MCS 15)</b>
151	(149, 153)			
153				
157				
159	(157, 161)			
161				
165				

Panel antenna with peak gain = 5dBi

### 14.12.4 Patch Antenna Model Maximum Conducted Transmit Power Settings

The following is an AP-6521 high transmit power table (Japan domain) per patch antenna in the 5GHz band:

<b>20 MHZ CHANNEL</b>	<b>40 MHZ CHANNEL</b>	<b>LEGACY OFDM RATES (6,9,12,18,24,36,48,54 MBPS)</b>	<b>802.11n HT20 RATES (MCS 0 MCS 15)</b>	<b>802.11n HT40 RATES (MCS 0 MCS 15)</b>
36		13.5	13.5	
38	(36, 40)	13.5	13.5	13.5
40		13.5	13.5	
42		13.5	13.5	
44		13.5	13.5	
46	(44, 48)	13.5	13.5	13.5
48		13.5	13.5	
52		13.5	13.5	
54	(52, 56)	13.5	13.5	13.5
56		13.5	13.5	
60		13.5	13.5	
62	(60, 64)	13.5	13.5	13.5
64		13.5	13.5	
100		19.0	19.0	
102	(100, 104)	19.0	19.0	19.0
104		19.0	19.0	
108		19.0	19.0	
112		19.0	19.0	
110	(108, 112)	19.0	19.0	19.0
116		19.0	19.0	
118	(116, 120)	19.0	19.0	19.0
120		19.0	19.0	
124		19.0	19.0	
126	(124, 128)	19.0	19.0	19.0
128		19.0	19.0	
132		19.0	19.0	
134	(132, 136)	19.0	19.0	19.0
136		19.0	19.0	
140		19.0	19.0	
149				

<b>20 MHZ CHANNEL</b>	<b>40 MHZ CHANNEL</b>	<b>LEGACY OFDM RATES (6,9,12,18,24,36,48,54 MBPS)</b>	<b>802.11n HT20 RATES (MCS 0 MCS 15)</b>	<b>802.11n HT40 RATES (MCS 0 MCS 15)</b>
151	(149, 153)			
153				
157				
159	(157, 161)			
161				
165				

Patch antenna with peak gain = 4dBi

# 15

## ***AP622, AP6522 and AP6562 Regulatory Domains***

### **15.1 US Regulatory Domain 2.4 GHz Band**

#### ***15.1.1 Internal Antenna Maximum Conducted Transmit Power Settings***

The following is a transmit power table (US domain) per internal antenna in the 2.4 GHz band:

<b><i>20 MHZ CHANNEL</i></b>	<b><i>40 MHZ CHANNEL</i></b>	<b><i>LEGACY DSSS RATES (1, 2, 5.5, 11 MBPS)</i></b>	<b><i>LEGACY OFDM RATES (6,9,12,18,24,36, 48,54 MBPS)</i></b>	<b><i>802.11n HT20 RATES (MCS 0 MCS 15)</i></b>	<b><i>802.11n HT40 RATES (MCS 0 MCS15)</i></b>
1		21.0	16.0	14.0	
2		21.0	21.0	21.0	
3	(1, 5)	21.0	21.0	21.0	11.5
4	(2, 6)	21.0	21.0	21.0	14.5
5	(3, 7)	21.0	21.0	21.0	14.5
6	(4, 8)	21.0	21.0	21.0	14.5
7	(5, 9)	21.0	21.0	21.0	14.5
8	(6, 10)	21.0	21.0	21.0	14.5
9	(7, 11)	21.0	21.0	21.0	13.0
10	(8, 12)	21.0	21.0	21.0	
11	(9, 13)	20.5	15.5	13.5	

Internal antenna, peak gain = 3.9dBi

### 15.1.2 Dipole Omni Antenna Maximum Conducted Transmit Power Settings

The following is a transmit power table (US domain) per dipole omni antenna in the 2.4 GHz band:

<b>20 MHZ CHANNEL</b>	<b>40 MHZ CHANNEL</b>	<b>LEGACY DSSS RATES (1, 2, 5.5, 11 MBPS)</b>	<b>LEGACY OFDM RATES (6,9,12,18,24,36, 48,54 MBPS)</b>	<b>802.11n HT20 RATES (MCS 0 MCS 15)</b>	<b>802.11n HT40 RATES (MCS 0 MCS15)</b>
1		21.0	15.5	15.0	
2		21.0	21.0	21.0	
3	(1, 5)	21.0	21.0	21.0	12.0
4	(2, 6)	21.0	21.0	21.0	15.0
5	(3, 7)	21.0	21.0	21.0	15.0
6	(4, 8)	21.0	21.0	21.0	15.0
7	(5, 9)	21.0	21.0	21.0	15.0
8	(6, 10)	21.0	21.0	21.0	15.0
9	(7, 11)	21.0	21.0	21.0	11.5
10	(8, 12)	21.0	21.0	21.0	
11	(9, 13)	20.5	16.0	13.0	

Dipole omni antenna, peak gain = 8.5dBi



### 15.1.3 Panel Antenna Maximum Conducted Transmit Power Settings

The following is a transmit power table (US domain) per panel antenna in the 2.4 GHz band:

<b>20 MHZ CHANNEL</b>	<b>40 MHZ CHANNEL</b>	<b>LEGACY DSSS RATES (1, 2, 5.5, 11 MBPS)</b>	<b>LEGACY OFDM RATES (6,9,12,18,24,36, 48,54 MBPS)</b>	<b>802.11n HT20 RATES (MCS 0 MCS 15)</b>	<b>802.11n HT40 RATES (MCS 0 MCS15)</b>
1		18.0	13.0	12.5	
2		20.0	14.0	14.5	
3	(1, 5)	20.0	14.0	14.5	8.5
4	(2, 6)	20.0	14.0	14.5	13.0
5	(3, 7)	20.0	14.0	14.5	13.0
6	(4, 8)	20.0	14.0	14.5	13.0
7	(5, 9)	20.0	14.0	14.5	13.0
8	(6, 10)	20.0	14.0	14.5	13.0
9	(7, 11)	20.0	14.0	14.5	8.0
10	(8, 12)	20.0	14.0	14.5	
11	(9, 13)	16.5	11.5	11.0	

Panel antenna, peak gain = 10.9dBi

### 15.1.4 Patch Antenna Maximum Conducted Transmit Power Settings

The following is a transmit power table (US domain) per patch antenna in the 2.4 GHz band:

<b>20 MHZ CHANNEL</b>	<b>40 MHZ CHANNEL</b>	<b>LEGACY DSSS RATES (1, 2, 5.5, 11 MBPS)</b>	<b>LEGACY OFDM RATES (6,9,12,18,24,36, 48,54 MBPS)</b>	<b>802.11n HT20 RATES (MCS 0 MCS 15)</b>	<b>802.11n HT40 RATES (MCS 0 MCS15)</b>
1		21.0	20.5	20.0	
2		21.0	21.0	21.0	
3	(1, 5)	21.0	21.0	21.0	17.5
4	(2, 6)	21.0	21.0	21.0	19.5
5	(3, 7)	21.0	21.0	21.0	19.5
6	(4, 8)	21.0	21.0	21.0	19.5
7	(5, 9)	21.0	21.0	21.0	19.5
8	(6, 10)	21.0	21.0	21.0	19.5
9	(7, 11)	21.0	21.0	21.0	14.5
10	(8, 12)	21.0	21.0	21.0	
11	(9, 13)	21.0	19.5	18.5	

Patch antenna, peak gain = 3.5dBi

### 15.1.5 Yagi Antenna Maximum Conducted Transmit Power Settings

The following is a transmit power table (US domain) per yagi antenna in the 2.4 GHz band:

<b>20 MHZ CHANNEL</b>	<b>40 MHZ CHANNEL</b>	<b>LEGACY DSSS RATES (1, 2, 5.5, 11 MBPS)</b>	<b>LEGACY OFDM RATES (6,9,12,18,24,36, 48,54 MBPS)</b>	<b>802.11n HT20 RATES (MCS 0 MCS 15)</b>	<b>802.11n HT40 RATES (MCS 0 MCS15)</b>
1		21.0	18.0	17.5	
2		21.0	21.0	21.0	
3	(1, 5)	21.0	21.0	21.0	14.5
4	(2, 6)	21.0	21.0	21.0	19.0
5	(3, 7)	21.0	21.0	21.0	19.0
6	(4, 8)	21.0	21.0	21.0	19.0
7	(5, 9)	21.0	21.0	21.0	19.0
8	(6, 10)	21.0	21.0	21.0	19.0
9	(7, 11)	21.0	21.0	21.0	14.0
10	(8, 12)	21.0	21.0	21.0	
11	(9, 13)	20.0	17.0	16.0	

Yagi antenna, peak gain = 11.1dBi

## 15.2 US Regulatory Domain 5 GHz Band

Dipole omni antenna, peak gain = 9dBi

### 15.2.1 Internal Antenna Model

The following is a transmit power table (US domain) per internal antenna in the 5 GHz band:

<b>20 MHZ CHANNEL</b>	<b>40 MHZ CHANNEL</b>	<b>LEGACY OFDM RATES (6,9,12,18,24,36,48,54 MBPS)</b>	<b>802.11n HT20 RATES (MCS 0 MCS 15)</b>	<b>802.11n HT40 RATES (MCS 0 MCS 15)</b>
36		10.5	13.5	
38	(36, 40)			13.0
40		11.0	13.0	
44		11.5	13.0	
46	(44, 48)			13.0
48		11.5	13.0	
52		19.0	20.0	
54	(52, 56)			20.0
56		18.5	20.0	
60		19.0	20.0	
62	(60, 64)			19.0
64		19.0	19.0	
100		20.0	18.0	
102	(100, 104)			17.0
104		20.0	19.0	
108		20.0	19.0	
110				18.5
112	(108, 112)	20.0	19.0	
116		20.0	19.0	
118	(116, 120)			
120				
124				
126	(124, 128)			
128				
132				
134	(132, 136)			20.0
136		20.0	19.0	

<b>20 MHZ CHANNEL</b>	<b>40 MHZ CHANNEL</b>	<b>LEGACY OFDM RATES (6,9,12,18,24,36,48,54 MBPS)</b>	<b>802.11n HT20 RATES (MCS 0 MCS 15)</b>	<b>802.11n HT40 RATES (MCS 0 MCS 15)</b>
140		18.5	20.0	
149		20.0	20.0	
151	(149, 153)			20.0
153		20.0	20.0	
157		20.0	20.0	
159	(157, 161)			20.0
161		20.0	20.0	
165		20.0	20.0	

Internal antenna, peak gain = 7.5dBi

## 15.2.2 Dipole Omni Antenna Model

The following is a transmit power table (US domain) per dipole omni antenna in the 5 GHz band:

<b>20 MHZ CHANNEL</b>	<b>40 MHZ CHANNEL</b>	<b>LEGACY OFDM RATES (6,9,12,18,24,36,48,54 MBPS)</b>	<b>802.11n HT20 RATES (MCS 0 MCS 15)</b>	<b>802.11n HT40 RATES (MCS 0 MCS 15)</b>
36		10.0	10.0	
38	(36, 40)			9.5
40		10.0	10.0	
44		10.0	10.0	
46	(44, 48)			10.0
48		10.5	10.5	
52		15.0	15.0	
54	(52, 56)			14.5
56		15.0	15.0	
60		15.0	15.0	
62	(60, 64)			14.5
64		15.0	15.0	
100		15.0	15.0	
102	(100, 104)			15.0
104		15.0	15.0	
108		15.0	15.0	
110				14.5
112	(108, 112)	15.0	15.0	
116		15.0	15.0	
118	(116, 120)			
120				
124				
126	(124, 128)			
128				
132				
134	(132, 136)			20.0
136		15.0	15.0	
140		15.0	15.0	
149		20.0	20.0	
151	(149, 153)			20.0
153		20.0	20.0	
157		20.0	20.0	

<b>20 MHZ CHANNEL</b>	<b>40 MHZ CHANNEL</b>	<b>LEGACY OFDM RATES (6,9,12,18,24,36,48,54 MBPS)</b>	<b>802.11n HT20 RATES (MCS 0 MCS 15)</b>	<b>802.11n HT40 RATES (MCS 0 MCS 15)</b>
159	(157, 161)			20.0
161		20.0	20.0	
165		20.0	20.0	

Dipole omni antenna, peak gain = 9dBi

### 15.2.3 Panel Antenna Model

The following is a transmit power table (US domain) per panel antenna in the 5 GHz band:

<b>20 MHZ CHANNEL</b>	<b>40 MHZ CHANNEL</b>	<b>LEGACY OFDM RATES (6,9,12,18,24,36,48,54 MBPS)</b>	<b>802.11n HT20 RATES (MCS 0 MCS 15)</b>	<b>802.11n HT40 RATES (MCS 0 MCS 15)</b>
36		11.5	11.0	
38	(36, 40)			10.5
40		11.5	11.0	
44		11.5	11.0	
46	(44, 48)			11.0
48		11.5	11.5	
52		15.5	16.0	
54	(52, 56)			15.5
56		15.5	16.0	
60		15.5	16.0	
62	(60, 64)			10.0
64		15.5	15.5	
100		15.5	15.5	
102	(100, 104)			15.0
104		15.5	15.0	
108		15.5	15.0	
110				14.5
112	(108, 112)	15.5	15.0	
116		15.0	15.0	
118	(116, 120)			
120				
124				
126	(124, 128)			
128				
132				
134	(132, 136)			15.5
136		15.0	15.0	
140		13.0	12.0	
149		20.0	19.0	
151	(149, 153)			19.0



<b>20 MHZ CHANNEL</b>	<b>40 MHZ CHANNEL</b>	<b>LEGACY OFDM RATES (6,9,12,18,24,36,48,54 MBPS)</b>	<b>802.11n HT20 RATES (MCS 0 MCS 15)</b>	<b>802.11n HT40 RATES (MCS 0 MCS 15)</b>
153		20.0	20.0	
157		20.0	20.0	
159	(157, 161)			20.0
161		20.0	20.0	
165		20.0	20.0	

Panel antenna, peak gain = 12.5dBi

## 15.2.4 Patch Antenna Model

The following is a transmit power table (US domain) per patch antenna in the 5 GHz band:

<b>20 MHZ CHANNEL</b>	<b>40 MHZ CHANNEL</b>	<b>LEGACY OFDM RATES (6,9,12,18,24,36,48,54 MBPS)</b>	<b>802.11n HT20 RATES (MCS 0 MCS 15)</b>	<b>802.11n HT40 RATES (MCS 0 MCS 15)</b>
36		14.0	14.0	
38	(36, 40)			13.5
40		14.5	14.5	
44		14.5	14.5	
46	(44, 48)			14.5
48		15.0	15.0	
52		19.5	19.5	
54	(52, 56)			19.0
56		19.5	19.5	
60		19.5	19.5	
62	(60, 64)			17.5
64		19.5	19.5	
100		20.0	20.0	
102	(100, 104)			15.5
104		20.0	20.0	
108		20.0	20.0	
110				19.5
112	(108, 112)	20.0	20.0	
116		20.0	20.0	
118	(116, 120)			
120				
124				
126	(124, 128)			
128				
132				
134	(132, 136)			20.0
136		20.0	20.0	
140		17.5	17.5	
149		20.0	20.0	
151	(149, 153)			20.0

<b>20 MHZ CHANNEL</b>	<b>40 MHZ CHANNEL</b>	<b>LEGACY OFDM RATES (6,9,12,18,24,36,48,54 MBPS)</b>	<b>802.11n HT20 RATES (MCS 0 MCS 15)</b>	<b>802.11n HT40 RATES (MCS 0 MCS 15)</b>
153		20.0	20.0	
157		20.0	20.0	
159	(157, 161)			20.0
161		20.0	20.0	
165		20.0	20.0	

Patch antenna, peak gain = 4.6dBi

## 15.2.5 Yagi Antenna Model

The following is a transmit power table (US domain) per yagi antenna in the 5 GHz band:

<b>20 MHZ CHANNEL</b>	<b>40 MHZ CHANNEL</b>	<b>LEGACY OFDM RATES (6,9,12,18,24,36,48,54 MBPS)</b>	<b>802.11n HT20 RATES (MCS 0 MCS 15)</b>	<b>802.11n HT40 RATES (MCS 0 MCS 15)</b>
36		13.0	13.0	
38	(36, 40)			12.0
40		13.0	13.0	
44		13.0	13.0	
46	(44, 48)			12.5
48		13.5	13.5	
52		17.5	17.5	
54	(52, 56)			17.0
56		17.5	17.5	
60		17.5	17.5	
62	(60, 64)			16.0
64		17.5	17.5	
100		18.0	18.0	
102	(100, 104)			17.5
104		18.0	18.0	
108		18.0	18.0	
110				17.5
112	(108, 112)	17.5	17.5	
116		17.5	17.5	
118	(116, 120)			
120				
124				
126	(124, 128)			
128				
132				
134	(132, 136)			18.0
136		18.0	18.0	
140		18.0	18.0	
149		20.0	20.0	
151	(149, 153)			20.0

<b>20 MHZ CHANNEL</b>	<b>40 MHZ CHANNEL</b>	<b>LEGACY OFDM RATES (6,9,12,18,24,36,48,54 MBPS)</b>	<b>802.11n HT20 RATES (MCS 0 MCS 15)</b>	<b>802.11n HT40 RATES (MCS 0 MCS 15)</b>
153		20.0	20.0	
157		20.0	20.0	
159	(157, 161)			20.0
161		20.0	20.0	
165		20.0	20.0	

Yagi antenna, peak gain = 11.0dBi

## 15.3 EU Regulatory Domain 2.4 GHz Band

### 15.3.1 Internal Antenna Model

The following is a transmit power table (EU domain) per internal antenna in the 2.4 GHz band:

<b>20 MHZ CHANNEL</b>	<b>40 MHZ CHANNEL</b>	<b>LEGACY DSSS RATES (1, 2, 5.5, 11 MBPS)</b>	<b>LEGACY OFDM RATES (6,9,12,18,24,36, 48,54 MBPS)</b>	<b>802.11n HT20 RATES (MCS 0 MCS 15)</b>	<b>802.11n HT40 RATES (MCS 0 MCS15)</b>
1		16.0	13.5	13.5	
2		16.0	13.5	13.5	
3	(1, 5)	16.0	13.5	13.5	13.5
4	(2, 6)	16.0	13.5	13.5	13.5
5	(3, 7)	16.0	13.5	13.5	13.5
6	(4, 8)	16.0	13.5	13.5	13.5
7	(5, 9)	16.0	13.5	13.5	13.5
8	(6, 10)	16.0	13.5	13.5	13.5
9	(7, 11)	16.0	13.5	13.5	13.5
10	(8, 12)	16.0	13.5	13.5	13.5
11	(9, 13)	16.0	13.5	13.5	13.5
12		16.0	13.5	13.5	
13		16.0	13.5	13.5	

Internal antenna, peak gain = 3.9dBi

### 15.3.2 Dipole Antenna Model

The following is a transmit power table (EU domain) per dipole antenna in the 2.4 GHz band:

<b>20 MHZ CHANNEL</b>	<b>40 MHZ CHANNEL</b>	<b>LEGACY DSSS RATES (1, 2, 5.5, 11 MBPS)</b>	<b>LEGACY OFDM RATES (6,9,12,18,24,36, 48,54 MBPS)</b>	<b>802.11n HT20 RATES (MCS 0 MCS 15)</b>	<b>802.11n HT40 RATES (MCS 0 MCS15)</b>
1		9.0	6.0	6.0	
2		9.5	6.5	6.0	
3	(1, 5)	9.5	6.5	6.0	5.5
4	(2, 6)	9.5	6.5	6.0	6.0
5	(3, 7)	9.5	6.5	6.0	6.0
6	(4, 8)	9.5	6.5	6.0	6.0
7	(5, 9)	9.5	6.5	6.0	6.0
8	(6, 10)	9.5	6.5	6.0	6.0
9	(7, 11)	9.5	6.5	6.0	6.0
10	(8, 12)	9.5	6.5	6.0	6.0
11	(9, 13)	9.5	6.5	6.0	6.0
12		9.5	6.5	6.0	
13		9.0	6.0	6.0	

Dipole antenna, peak gain = 8.5dBi

### 15.3.3 Panel Antenna Model

The following is a transmit power table (EU domain) per panel antenna in the 2.4 GHz band:

<b>20 MHZ CHANNEL</b>	<b>40 MHZ CHANNEL</b>	<b>LEGACY DSSS RATES (1, 2, 5.5, 11 MBPS)</b>	<b>LEGACY OFDM RATES (6,9,12,18,24,36, 48,54 MBPS)</b>	<b>802.11n HT20 RATES (MCS 0 MCS 15)</b>	<b>802.11n HT40 RATES (MCS 0 MCS15)</b>
1		6.5	6.0	6.0	
2		6.5	6.5	6.5	
3	(1, 5)	6.5	6.5	6.5	6.0
4	(2, 6)	6.5	6.5	6.5	6.0
5	(3, 7)	6.5	6.5	6.5	6.0
6	(4, 8)	6.5	6.5	6.5	6.0
7	(5, 9)	6.5	6.5	6.5	6.0
8	(6, 10)	6.5	6.5	6.5	6.0
9	(7, 11)	6.5	6.5	6.5	6.0
10	(8, 12)	6.5	6.5	6.5	6.0
11	(9, 13)	6.5	6.5	6.5	6.0
12		6.5	6.5	6.5	
13		6.5	5.5	5.5	

Panel antenna, peak gain = 10.9dBi



### 15.3.4 Patch Antenna Model

The following is a transmit power table (EU domain) per patch antenna in the 2.4 GHz band:

<b>20 MHZ CHANNEL</b>	<b>40 MHZ CHANNEL</b>	<b>LEGACY DSSS RATES (1, 2, 5.5, 11 MBPS)</b>	<b>LEGACY OFDM RATES (6,9,12,18,24,36, 48,54 MBPS)</b>	<b>802.11n HT20 RATES (MCS 0 MCS 15)</b>	<b>802.11n HT40 RATES (MCS 0 MCS15)</b>
1		14.0	11.5	11.0	
2		14.5	12.0	11.0	
3	(1, 5)	14.5	12.0	11.0	10.5
4	(2, 6)	14.5	12.0	11.0	11.0
5	(3, 7)	14.5	12.0	11.0	11.0
6	(4, 8)	14.5	12.0	11.0	11.0
7	(5, 9)	14.5	12.0	11.0	11.0
8	(6, 10)	14.5	12.0	11.0	11.0
9	(7, 11)	14.5	12.0	11.0	11.0
10	(8, 12)	14.5	12.0	11.0	11.0
11	(9, 13)	14.5	12.0	11.0	11.5
12		14.5	12.0	11.0	
13		14.0	11.5	10.0	

Patch antenna, peak gain = 3.5dBi

### 15.3.5 Yagi Antenna Model

The following is a transmit power table (EU domain) per yagi antenna in the 2.4 GHz band:

<b>20 MHZ CHANNEL</b>	<b>40 MHZ CHANNEL</b>	<b>LEGACY DSSS RATES (1, 2, 5.5, 11 MBPS)</b>	<b>LEGACY OFDM RATES (6,9,12,18,24,36, 48,54 MBPS)</b>	<b>802.11n HT20 RATES (MCS 0 MCS 15)</b>	<b>802.11n HT40 RATES (MCS 0 MCS15)</b>
1		6.5	6.5	6.5	
2		6.5	6.5	6.5	
3	(1, 5)	6.5	6.5	6.5	6.5
4	(2, 6)	6.5	6.5	6.5	6.5
5	(3, 7)	6.5	6.5	6.5	6.5
6	(4, 8)	6.5	6.5	6.5	6.5
7	(5, 9)	6.5	6.5	6.5	6.5
8	(6, 10)	6.5	6.5	6.5	6.5
9	(7, 11)	6.5	6.5	6.5	6.5
10	(8, 12)	6.5	6.5	6.5	6.5
11	(9, 13)	6.5	6.5	6.5	6.5
12		6.5	6.5	6.5	
13		6.5	6.0	6.0	

Yagi antenna, peak gain = 11.1dBi

## 15.4 EU Regulatory Domain 5 GHz Band

### 15.4.1 Internal Antenna Model

The following is a transmit power table (EU domain) per internal antenna in the 5 GHz band:

<b>20 MHZ CHANNEL</b>	<b>40 MHZ CHANNEL</b>	<b>LEGACY OFDM RATES (6,9,12,18,24,36,48,54 MBPS)</b>	<b>802.11n HT20 RATES (MCS 0 MCS 15)</b>	<b>802.11n HT40 RATES (MCS 0 MCS 15)</b>
36		13.5	13.5	
38	(36, 40)			13.0
40		13.5	13.5	
44		13.5	13.5	
46	(44, 48)			13.0
48		13.5	13.5	
52		10.5	10.5	
54	(52, 56)			10.5.0
56		10.5	10.5	
60		10.5	10.5	
62	(60, 64)			10.5
64		10.5	10.5	
100		18.0	18.0	
102	(100, 104)			18.0
104		18.0	18.0	
108		18.0	18.0	
110				18.0
112	(108, 112)	18.0	18.0	
116		18.0	18.0	
118	(116, 120)			
120				
124				
126	(124, 128)			
128				
132				
134	(132, 136)			18.0
136		18.0	18.0	
140		18.0	18.0	
149				

<b>20 MHZ CHANNEL</b>	<b>40 MHZ CHANNEL</b>	<b>LEGACY OFDM RATES (6,9,12,18,24,36,48,54 MBPS)</b>	<b>802.11n HT20 RATES (MCS 0 MCS 15)</b>	<b>802.11n HT40 RATES (MCS 0 MCS 15)</b>
151	(149, 153)			
153				
157				
159	(157, 161)			
161				
165				

Internal antenna, peak gain = 7.5dBi

### 15.4.2 Dipole Omni Antenna Model

The following is a transmit power table (EU domain) per dipole omni antenna in the 5 GHz band:

<b>20 MHZ CHANNEL</b>	<b>40 MHZ CHANNEL</b>	<b>LEGACY OFDM RATES (6,9,12,18,24,36,48,54 MBPS)</b>	<b>802.11n HT20 RATES (MCS 0 MCS 15)</b>	<b>802.11n HT40 RATES (MCS 0 MCS 15)</b>
36		7.5	7.5	
38	(36, 40)			6.0
40		7.5	7.5	
44		7.5	7.5	
46	(44, 48)			6.0
48		7.5	7.5	
52		4.5	4.5	
54	(52, 56)			4.0
56		4.5	4.5	
60		4.5	4.5	
62	(60, 64)			4.0
64		4.5	4.5	
100		11.5	11.5	
102	(100, 104)			11.0
104		11.5	11.5	
108		11.5	11.5	
110				11.0
112	(108, 112)	11.5	11.5	
116		11.5	11.5	
118	(116, 120)			
120				
124				
126	(124, 128)			
128				
132				
134	(132, 136)			11.0
136		11.0	11.0	
140		11.0	11.0	
149				
151	(149, 153)			

<b>20 MHZ CHANNEL</b>	<b>40 MHZ CHANNEL</b>	<b>LEGACY OFDM RATES (6,9,12,18,24,36,48,54 MBPS)</b>	<b>802.11n HT20 RATES (MCS 0 MCS 15)</b>	<b>802.11n HT40 RATES (MCS 0 MCS 15)</b>
153				
157				
159	(157, 161)			
161				
165				

Dipole omni antenna, peak gain = 9dBi

### 15.4.3 Panel Antenna Model

The following is a transmit power table (EU domain) per panel antenna in the 5 GHz band:

<b>20 MHZ CHANNEL</b>	<b>40 MHZ CHANNEL</b>	<b>LEGACY OFDM RATES (6,9,12,18,24,36,48,54 MBPS)</b>	<b>802.11n HT20 RATES (MCS 0 MCS 15)</b>	<b>802.11n HT40 RATES (MCS 0 MCS 15)</b>
36		6.0	6.0	
38	(36, 40)			6.0
40		6.0	6.0	
44		6.0	6.0	
46	(44, 48)			6.0
48		6.0	6.0	
52		3.5	3.5	
54	(52, 56)			3.5
56		3.5	3.5	
60		3.5	3.5	
62	(60, 64)			3.5
64		3.5	3.5	
100		9.0	9.0	
102	(100, 104)			8.5
104		9.0	9.0	
108		9.0	9.0	
110				8.5
112	(108, 112)	9.0	9.0	
116		9.0	9.0	
118	(116, 120)			
120				
124				
126	(124, 128)			
128				
132				
134	(132, 136)			8.0
136		8.0	8.0	
140		8.0	8.0	
149				
151	(149, 153)			

<b>20 MHZ CHANNEL</b>	<b>40 MHZ CHANNEL</b>	<b>LEGACY OFDM RATES (6,9,12,18,24,36,48,54 MBPS)</b>	<b>802.11n HT20 RATES (MCS 0 MCS 15)</b>	<b>802.11n HT40 RATES (MCS 0 MCS 15)</b>
153				
157				
159	(157, 161)			
161				
165				

Panel antenna, peak gain = 12.5dBi



### 15.4.4 Patch Antenna Model

The following is a transmit power table (EU domain) per patch antenna in the 5 GHz band:

<b>20 MHZ CHANNEL</b>	<b>40 MHZ CHANNEL</b>	<b>LEGACY OFDM RATES (6,9,12,18,24,36,48,54 MBPS)</b>	<b>802.11n HT20 RATES (MCS 0 MCS 15)</b>	<b>802.11n HT40 RATES (MCS 0 MCS 15)</b>
36		11.5	11.5	
38	(36, 40)			11.0
40		11.5	11.5	
44		11.5	11.5	
46	(44, 48)			11.0
48		11.5	11.5	
52		8.5	8.5	
54	(52, 56)			8.0
56		8.5	8.5	
60		8.5	8.5	
62	(60, 64)			8.0
64		8.5	8.5	
100		15.0	15.0	
102	(100, 104)			15.5
104		15.0	15.0	
108		15.0	15.0	
110				15.5
112	(108, 112)	15.0	15.0	
116		15.0	15.0	
118	(116, 120)			
120				
124				
126	(124, 128)			
128				
132				
134	(132, 136)			16.0
136		15.0	15.0	
140		15.5	15.5	
149				
151	(149, 153)			

<b>20 MHZ CHANNEL</b>	<b>40 MHZ CHANNEL</b>	<b>LEGACY OFDM RATES (6,9,12,18,24,36,48,54 MBPS)</b>	<b>802.11n HT20 RATES (MCS 0 MCS 15)</b>	<b>802.11n HT40 RATES (MCS 0 MCS 15)</b>
153				
157				
159	(157, 161)			
161				
165				

Patch antenna, peak gain = 10dBi

### 15.4.5 Yagi Antenna Model

The following is a transmit power table (EU domain) per yagi antenna in the 5 GHz band:

<b>20 MHZ CHANNEL</b>	<b>40 MHZ CHANNEL</b>	<b>LEGACY OFDM RATES (6,9,12,18,24,36,48,54 MBPS)</b>	<b>802.11n HT20 RATES (MCS 0 MCS 15)</b>	<b>802.11n HT40 RATES (MCS 0 MCS 15)</b>
36		8.0	8.0	
38	(36, 40)			7.5
40		8.0	8.0	
44		8.0	8.0	
46	(44, 48)			7.5
48		8.0	8.0	
52		4.0	4.0	
54	(52, 56)			3.5
56		4.0	4.0	
60		4.0	4.0	
62	(60, 64)			3.5
64		4.0	4.0	
100		10.5	10.5	
102	(100, 104)			9.5
104		10.5	10.5	
108		10.5	10.5	
110				9.5
112	(108, 112)	10.5	10.5	
116		10.5	10.5	
118	(116, 120)			
120				
124				
126	(124, 128)			
128				
132				
134	(132, 136)			9.5
136		10.5	10.5	
140		9.5	9.5	
149				
151	(149, 153)			

<b>20 MHZ CHANNEL</b>	<b>40 MHZ CHANNEL</b>	<b>LEGACY OFDM RATES (6,9,12,18,24,36,48,54 MBPS)</b>	<b>802.11n HT20 RATES (MCS 0 MCS 15)</b>	<b>802.11n HT40 RATES (MCS 0 MCS 15)</b>
153				
157				
159	(157, 161)			
161				
165				

Yagi antenna, peak gain = 11dBi

## 15.5 Japan Regulatory Domain 2.4 GHz Band

### 15.5.1 Internal Antenna Model

The following is a transmit power table (Japan domain) per internal antenna in the 2.4 GHz band:

<b>20 MHZ CHANNEL</b>	<b>40 MHZ CHANNEL</b>	<b>LEGACY DSSS RATES (1, 2, 5.5, 11 MBPS)</b>	<b>LEGACY OFDM RATES (6,9,12,18,24,36, 48,54 MBPS)</b>	<b>802.11n HT20 RATES (MCS 0 MCS 15)</b>	<b>802.11n HT40 RATES (MCS 0 MCS15)</b>
1		17.0	16.5	17.5	
2		17.0	16.5	17.5	
3	(1, 5)	17.0	16.5	17.5	17.5
4	(2, 6)	17.0	16.5	17.5	17.5
5	(3, 7)	17.0	16.5	17.5	17.5
6	(4, 8)	17.0	16.5	17.5	17.5
7	(5, 9)	17.0	16.5	17.5	17.5
8	(6, 10)	17.0	16.5	17.5	17.5
9	(7, 11)	17.0	16.5	17.5	17.5
10	(8, 12)	17.0	16.5	17.5	17.5
11	(9, 13)	17.0	16.5	17.5	17.5
12		17.0	16.5	17.5	
13		17.0	16.5	17.5	

Internal antenna, peak gain = 3.9dBi

## 15.5.2 Dipole Antenna Model

The following is a transmit power table (Japan domain) per dipole antenna in the 2.4 GHz band:

<b>20 MHZ CHANNEL</b>	<b>40 MHZ CHANNEL</b>	<b>LEGACY DSSS RATES (1, 2, 5.5, 11 MBPS)</b>	<b>LEGACY OFDM RATES (6,9,12,18,24,36, 48,54 MBPS)</b>	<b>802.11n HT20 RATES (MCS 0 MCS 15)</b>	<b>802.11n HT40 RATES (MCS 0 MCS15)</b>
1		11.0	10.5	11.5	
2		11.0	10.5	11.5	
3	(1, 5)	11.0	10.5	11.5	11.5
4	(2, 6)	11.0	10.5	11.5	11.5
5	(3, 7)	11.0	10.5	11.5	11.5
6	(4, 8)	11.0	10.5	11.5	11.5
7	(5, 9)	11.0	10.5	11.5	11.5
8	(6, 10)	11.0	10.5	11.5	11.5
9	(7, 11)	11.0	10.5	11.5	11.5
10	(8, 12)	11.0	10.5	11.5	11.5
11	(9, 13)	11.0	10.5	11.5	11.5
12		11.0	10.5	11.5	
13		11.0	10.5	11.5	

Dipole antenna, peak gain = 8.5dBi

### 15.5.3 Panel Antenna Model

The following is a transmit power table (Japan domain) per panel antenna in the 2.4 GHz band:

<b>20 MHZ CHANNEL</b>	<b>40 MHZ CHANNEL</b>	<b>LEGACY DSSS RATES (1, 2, 5.5, 11 MBPS)</b>	<b>LEGACY OFDM RATES (6,9,12,18,24,36, 48,54 MBPS)</b>	<b>802.11n HT20 RATES (MCS 0 MCS 15)</b>	<b>802.11n HT40 RATES (MCS 0 MCS15)</b>
1		6.0	5.5	6.5	
2		6.0	5.5	6.5	
3	(1, 5)	6.0	5.5	6.5	6.5
4	(2, 6)	6.0	5.5	6.5	6.5
5	(3, 7)	6.0	5.5	6.5	6.5
6	(4, 8)	6.0	5.5	6.5	6.5
7	(5, 9)	6.0	5.5	6.5	6.5
8	(6, 10)	6.0	5.5	6.5	6.5
9	(7, 11)	6.0	5.5	6.5	6.5
10	(8, 12)	6.0	5.5	6.5	6.5
11	(9, 13)	6.0	5.5	6.5	6.5
12		6.0	5.5	6.5	
13		6.0	5.5	6.5	

Panel antenna, peak gain = 10.9dBi

### 15.5.4 Patch Antenna Model

The following is a transmit power table (Japan domain) per patch antenna in the 2.4 GHz band:

<b>20 MHZ CHANNEL</b>	<b>40 MHZ CHANNEL</b>	<b>LEGACY DSSS RATES (1, 2, 5.5, 11 MBPS)</b>	<b>LEGACY OFDM RATES (6,9,12,18,24,36, 48,54 MBPS)</b>	<b>802.11n HT20 RATES (MCS 0 MCS 15)</b>	<b>802.11n HT40 RATES (MCS 0 MCS15)</b>
1		15.0	14.5	15.5	
2		15.0	14.5	15.5	
3	(1, 5)	15.0	14.5	15.5	15.5
4	(2, 6)	15.0	14.5	15.5	15.5
5	(3, 7)	15.0	14.5	15.5	15.5
6	(4, 8)	15.0	14.5	15.5	15.5
7	(5, 9)	15.0	14.5	15.5	15.5
8	(6, 10)	15.0	14.5	15.5	15.5
9	(7, 11)	15.0	14.5	15.5	15.5
10	(8, 12)	15.0	14.5	15.5	15.5
11	(9, 13)	15.0	14.5	15.5	15.5
12		15.0	14.5	15.5	
13		15.0	14.5	15.5	

Patch antenna, peak gain = 3.5dBi



### 15.5.5 Yagi Antenna Model

The following is a transmit power table (Japan domain) per yagi antenna in the 2.4 GHz band:

<b>20 MHZ CHANNEL</b>	<b>40 MHZ CHANNEL</b>	<b>LEGACY DSSS RATES (1, 2, 5.5, 11 MBPS)</b>	<b>LEGACY OFDM RATES (6,9,12,18,24,36, 48,54 MBPS)</b>	<b>802.11n HT20 RATES (MCS 0 MCS 15)</b>	<b>802.11n HT40 RATES (MCS 0 MCS15)</b>
1		6.0	5.5	6.5	
2		6.0	5.5	6.5	
3	(1, 5)	6.0	5.5	6.5	6.5
4	(2, 6)	6.0	5.5	6.5	6.5
5	(3, 7)	6.0	5.5	6.5	6.5
6	(4, 8)	6.0	5.5	6.5	6.5
7	(5, 9)	6.0	5.5	6.5	6.5
8	(6, 10)	6.0	5.5	6.5	6.5
9	(7, 11)	6.0	5.5	6.5	6.5
10	(8, 12)	6.0	5.5	6.5	6.5
11	(9, 13)	6.0	5.5	6.5	6.5
12		6.0	5.5	6.5	
13		6.0	5.5	6.5	

Yagi antenna, peak gain = 11.1dBi

## 15.6 Japan Regulatory Domain 5 GHz Band

### 15.6.1 Internal Antenna Model

The following is a transmit power table (Japan domain) per internal antenna in the 5 GHz band:

<b>20 MHZ CHANNEL</b>	<b>40 MHZ CHANNEL</b>	<b>LEGACY OFDM RATES (6,9,12,18,24,36,48,54 MBPS)</b>	<b>802.11n HT20 RATES (MCS 0 MCS 15)</b>	<b>802.11n HT40 RATES (MCS 0 MCS 15)</b>
36		10.5	11.5	
38	(36, 40)			11.5
40		10.5	11.5	
44		10.5	11.5	
46	(44, 48)			11.5
48		10.5	11.5	
52		11.5	11.5	
54	(52, 56)			10.5
56		11.5	11.5	
60		11.5	11.5	
62	(60, 64)			10.5
64		11.5	11.5	
100		16.5	17.5	
102	(100, 104)			16.5
104		16.5	17.5	
108		16.5	17.5	
110				16.5
112	(108, 112)	16.5	17.5	
116		16.5	17.5	
118	(116, 120)			
120				
124				
126	(124, 128)			
128				
132				
134	(132, 136)			16.5
136		16.5	17.5	
140		16.5	17.5	
149				

<b>20 MHZ CHANNEL</b>	<b>40 MHZ CHANNEL</b>	<b>LEGACY OFDM RATES (6,9,12,18,24,36,48,54 MBPS)</b>	<b>802.11n HT20 RATES (MCS 0 MCS 15)</b>	<b>802.11n HT40 RATES (MCS 0 MCS 15)</b>
151	(149, 153)			
153				
157				
159	(157, 161)			
161				
165				

Internal antenna, peak gain = 7.5dBi

## 15.6.2 Dipole Omni Antenna Model

The following is a transmit power table (Japan domain) per dipole omni antenna in the 5 GHz band:

<b>20 MHZ CHANNEL</b>	<b>40 MHZ CHANNEL</b>	<b>LEGACY OFDM RATES (6,9,12,18,24,36,48,54 MBPS)</b>	<b>802.11n HT20 RATES (MCS 0 MCS 15)</b>	<b>802.11n HT40 RATES (MCS 0 MCS 15)</b>
36		6.5	7.5	
38	(36, 40)			7.5
40		6.5	7.5	
44		6.5	7.5	
46	(44, 48)			7.5
48		6.5	7.5	
52		7.5	7.5	
54	(52, 56)			6.5
56		7.5	7.5	
60		7.5	7.5	
62	(60, 64)			6.5
64		7.5	7.5	
100		12.5	13.5	
102	(100, 104)			12.5
104		12.5	13.5	
108		12.5	13.5	
110				12.5
112	(108, 112)	12.5	13.5	
116		12.5	13.5	
118	(116, 120)			
120				
124				
126	(124, 128)			
128				
132				
134	(132, 136)			12.5
136		12.5	13.5	
140		12.5	13.5	
149				
151	(149, 153)			

<b>20 MHZ CHANNEL</b>	<b>40 MHZ CHANNEL</b>	<b>LEGACY OFDM RATES (6,9,12,18,24,36,48,54 MBPS)</b>	<b>802.11n HT20 RATES (MCS 0 MCS 15)</b>	<b>802.11n HT40 RATES (MCS 0 MCS 15)</b>
153				
157				
159	(157, 161)			
161				
165				

Dipole omni antenna, peak gain = 9dBi

### 15.6.3 Panel Antenna Model

The following is a transmit power table (Japan domain) per panel antenna in the 5 GHz band:

<b>20 MHZ CHANNEL</b>	<b>40 MHZ CHANNEL</b>	<b>LEGACY OFDM RATES (6,9,12,18,24,36,48,54 MBPS)</b>	<b>802.11n HT20 RATES (MCS 0 MCS 15)</b>	<b>802.11n HT40 RATES (MCS 0 MCS 15)</b>
36		3.5	4.5	
38	(36, 40)			4.5
40		3.5	4.5	
44		3.5	4.5	
46	(44, 48)			4.5
48		3.5	4.5	
52		4.5	4.5	
54	(52, 56)			3.5
56		4.5	4.5	
60		4.5	4.5	
62	(60, 64)			3.5
64		4.5	4.5	
100		9.5	10.5	
102	(100, 104)			9.5
104		9.5	10.5	
108		9.5	10.5	
110				9.5
112	(108, 112)	9.5	10.5	
116		9.5	10.5	
118	(116, 120)			
120				
124				
126	(124, 128)			
128				
132				
134	(132, 136)			9.5
136		9.5	10.5	
140		9.5	10.5	
149				
151	(149, 153)			

<b>20 MHZ CHANNEL</b>	<b>40 MHZ CHANNEL</b>	<b>LEGACY OFDM RATES (6,9,12,18,24,36,48,54 MBPS)</b>	<b>802.11n HT20 RATES (MCS 0 MCS 15)</b>	<b>802.11n HT40 RATES (MCS 0 MCS 15)</b>
153				
157				
159	(157, 161)			
161				
165				

Panel antenna, peak gain = 12.5dBi

### 15.6.4 Patch Antenna Model

The following is a transmit power table (Japan domain) per patch antenna in the 5 GHz band:

<b>20 MHZ CHANNEL</b>	<b>40 MHZ CHANNEL</b>	<b>LEGACY OFDM RATES (6,9,12,18,24,36,48,54 MBPS)</b>	<b>802.11n HT20 RATES (MCS 0 MCS 15)</b>	<b>802.11n HT40 RATES (MCS 0 MCS 15)</b>
36		10.5	11.5	
38	(36, 40)			11.5
40		10.5	11.5	
44		10.5	11.5	
46	(44, 48)			11.5
48		10.5	11.5	
52		11.5	11.5	
54	(52, 56)			10.5
56		11.5	11.5	
60		11.5	11.5	
62	(60, 64)			10.5
64		11.5	11.5	
100		16.5	17.5	
102	(100, 104)			16.5
104		16.5	17.5	
108		16.5	17.5	
110				16.5
112	(108, 112)	16.5	17.5	
116		16.5	17.5	
118	(116, 120)			
120				
124				
126	(124, 128)			
128				
132				
134	(132, 136)			16.5
136		16.5	17.5	
140		16.5	17.5	
149				
151	(149, 153)			



<b>20 MHZ CHANNEL</b>	<b>40 MHZ CHANNEL</b>	<b>LEGACY OFDM RATES (6,9,12,18,24,36,48,54 MBPS)</b>	<b>802.11n HT20 RATES (MCS 0 MCS 15)</b>	<b>802.11n HT40 RATES (MCS 0 MCS 15)</b>
153				
157				
159	(157, 161)			
161				
165				

Patch antenna, peak gain = 10dBi

### 15.6.5 Yagi Antenna Model

The following is a transmit power table (Japan domain) per yagi antenna in the 5 GHz band:

<b>20 MHZ CHANNEL</b>	<b>40 MHZ CHANNEL</b>	<b>LEGACY OFDM RATES (6,9,12,18,24,36,48,54 MBPS)</b>	<b>802.11n HT20 RATES (MCS 0 MCS 15)</b>	<b>802.11n HT40 RATES (MCS 0 MCS 15)</b>
36		4.5	5.5	
38	(36, 40)			5.5
40		4.5	5.5	
44		4.5	5.5	
46	(44, 48)			5.5
48		4.5	5.5	
52		5.5	5.5	
54	(52, 56)			4.5
56		5.5	5.5	
60		5.5	5.5	
62	(60, 64)			4.5
64		5.5	5.5	
100		10.5	11.5	
102	(100, 104)			10.5
104		10.5	11.5	
108		10.5	11.5	
110				10.5
112	(108, 112)	10.5	11.5	
116		10.5	11.5	
118	(116, 120)			
120				
124				
126	(124, 128)			
128				
132				
134	(132, 136)			10.5
136		10.5	11.5	
140		10.5	11.5	
149				
151	(149, 153)			

<b>20 MHZ CHANNEL</b>	<b>40 MHZ CHANNEL</b>	<b>LEGACY OFDM RATES (6,9,12,18,24,36,48,54 MBPS)</b>	<b>802.11n HT20 RATES (MCS 0 MCS 15)</b>	<b>802.11n HT40 RATES (MCS 0 MCS 15)</b>
153				
157				
159	(157, 161)			
161				
165				

Yagi antenna, peak gain = 11dBi



# 16

## ***AP7161 Regulatory Domains***

### **16.1 US Regulatory Domain 2.4 GHz Band**

#### ***16.1.1 Dipole Omni Antenna Maximum Conducted Transmit Power Settings***

The following is a transmit power table (US domain) per dipole omni antenna in the 2.4 GHz band:

<b>20 MHZ CHANNEL</b>	<b>40 MHZ CHANNEL</b>	<b>LEGACY DSSS RATES (1, 2, 5.5, 11 MBPS)</b>	<b>LEGACY OFDM RATES (6,9,12,18,24,36, 48,54 MBPS)</b>	<b>802.11n HT20 RATES (MCS 0 MCS 15)</b>	<b>802.11n HT40 RATES (MCS 0 MCS15)</b>
1		18.5	16.5	16.5	
2		19.0	16.5	16.5	
3	(1, 5)	19.0	16.5	16.5	15.5
4	(2, 6)	19.0	16.5	16.5	15.5
5	(3, 7)	19.0	16.5	16.5	15.5
6	(4, 8)	19.0	16.5	16.5	15.0
7	(5, 9)	19.0	16.5	18.0	15.0
8	(6, 10)	19.0	16.5	18.0	15.0
9	(7, 11)	19.0	18.0	18.0	15.0
10		19.0	18.0	18.0	
11		18.0	18.0	18.0	

Internal antenna, peak gain = 8.0dBi

## 16.2 US Regulatory Domain 4.9 GHz Band

### 16.2.1 Dipole Omni Antenna Model - 3Tx Transmitter Configuration

The following is a transmit power table (US domain) per dipole omni antenna in the 4.9 GHz band (3Tx):

<b>20 MHZ CHANNEL</b>	<b>40 MHZ CHANNEL</b>	<b>LEGACY DSSS RATES (1, 2, 5.5, 11 MBPS)</b>	<b>LEGACY OFDM RATES (6,9,12,18,24,36, 48,54 MBPS)</b>	<b>802.11n HT20 RATES (MCS 0 MCS 15)</b>	<b>802.11n HT40 RATES (MCS 0 MCS15)</b>
21			9.5	9.5	
25			9.5	9.5	

Internal antenna, peak gain = 10.5dBi

### 16.2.2 Dipole Omni Antenna Model - 1Tx Transmitter Configuration

The following is a transmit power table (US domain) per dipole omni antenna in the 4.9 GHz band (1Tx):

<b>20 MHZ CHANNEL</b>	<b>40 MHZ CHANNEL</b>	<b>LEGACY DSSS RATES (1, 2, 5.5, 11 MBPS)</b>	<b>LEGACY OFDM RATES (6,9,12,18,24,36, 48,54 MBPS)</b>	<b>802.11n HT20 RATES (MCS 0 MCS 15)</b>	<b>802.11n HT40 RATES (MCS 0 MCS15)</b>
21			18.5	18.5	
25			19.0	19.0	

Internal antenna, peak gain = 10.5dBi

## 16.3 US Regulatory Domain 5 GHz Band

### 16.3.1 Dipole Omni Antenna Model

The following is a transmit power table (US domain) per dipole omni antenna in the 5 GHz band:

<b>20 MHZ CHANNEL</b>	<b>40 MHZ CHANNEL</b>	<b>LEGACY OFDM RATES (6,9,12,18,24,36,48,54 MBPS)</b>	<b>802.11n HT20 RATES (MCS 0 MCS 15)</b>	<b>802.11n HT40 RATES (MCS 0 MCS 15)</b>
36				
38	(36, 40)			
40				
44				
46	(44, 48)			
48				
52		9.5	10.0	
54	(52, 56)			120
56		9.5	10.0	
60		9.0	9.5	
62	(60, 64)			12.0
64		9.5	10.0	
100		7.5	8.0	
102	(100, 104)			10.5
104		9.5	10.0	
108		9.5	10.0	
110				10.5
112	(108, 112)	9.5	10.0	
116		9.5	10.0	
118	(116, 120)			
120		9.5	10.0	
124		11.0	11.0	
126	(124, 128)			12.5
128		11.0	11.0	
132		11.0	11.0	
134	(132, 136)			12.5
136		11.0	11.0	
140		11.0	11.0	
149		19.0	19.0	
151	(149, 153)			15.5
153		19.0	19.0	
157		17.0	16.5	

<b>20 MHZ CHANNEL</b>	<b>40 MHZ CHANNEL</b>	<b>LEGACY OFDM RATES (6,9,12,18,24,36,48,54 MBPS)</b>	<b>802.11n HT20 RATES (MCS 0 MCS 15)</b>	<b>802.11n HT40 RATES (MCS 0 MCS 15)</b>
159	(157, 161)			17.0
161		17.0	17.5	
165		17.0	17.5	

Yagi antenna, peak gain = 10.5dBi



## 16.4 EU Regulatory Domain 2.4 GHz Band

### 16.4.1 Dipole Omni Antenna Model

The following is a transmit power table (EU domain) per dipole omni antenna in the 2.4 GHz band:

<b>20 MHZ CHANNEL</b>	<b>40 MHZ CHANNEL</b>	<b>LEGACY DSSS RATES (1, 2, 5.5, 11 MBPS)</b>	<b>LEGACY OFDM RATES (6,9,12,18,24,36, 48,54 MBPS)</b>	<b>802.11n HT20 RATES (MCS 0 MCS 15)</b>	<b>802.11n HT40 RATES (MCS 0 MCS15)</b>
1		6.0	6.0	5.0	
2		6.0	6.0	5.0	
3	(1, 5)	6.0	6.0	5.0	7.0
4	(2, 6)	6.0	5.5	5.0	7.0
5	(3, 7)	6.0	5.5	5.0	7.0
6	(4, 8)	6.0	5.5	5.0	7.0
7	(5, 9)	6.0	5.5	5.0	7.0
8	(6, 10)	6.0	5.5	5.0	7.0
9	(7, 11)	6.0	5.0	5.0	7.0
10		6.0	5.0	5.0	
11		6.0	5.0	5.0	
12					
13					

Internal antenna, peak gain = 8.0dBi

## 16.5 EU Regulatory Domain 5 GHz Band

### 16.5.1 Dipole Omni Antenna Model

The following is a transmit power table (EU domain) per dipole omni antenna in the 5 GHz band:

<b>20 MHZ CHANNEL</b>	<b>40 MHZ CHANNEL</b>	<b>LEGACY OFDM RATES (6,9,12,18,24,36,48,54 MBPS)</b>	<b>802.11n HT20 RATES (MCS 0 MCS 15)</b>	<b>802.11n HT40 RATES (MCS 0 MCS 15)</b>
36		8.5	8.5	
38	(36, 40)			9.0
40		8.5	8.5	
44		8.5	8.5	
46	(44, 48)			9.0
48		8.5	8.5	
52		7.0	7.0	
54	(52, 56)			7.5
56		7.0	7.0	
60		7.0	7.0	
62	(60, 64)			7.5
64		7.0	7.0	
100		14.5	14.5	
102	(100, 104)			16.0
104		14.5	14.5	
108		14.5	14.5	
110				16.0
112	(108, 112)	14.5	14.5	
116		14.5	14.5	
118	(116, 120)			16.0
120		14.5	14.5	
124		14.5	14.5	
126	(124, 128)			16.0
128		14.5	14.5	
132		14.5	14.5	
134	(132, 136)			16.0
136		14.5	14.5	
140		14.5	14.5	
149		10.5	10.5	

<b>20 MHZ CHANNEL</b>	<b>40 MHZ CHANNEL</b>	<b>LEGACY OFDM RATES (6,9,12,18,24,36,48,54 MBPS)</b>	<b>802.11n HT20 RATES (MCS 0 MCS 15)</b>	<b>802.11n HT40 RATES (MCS 0 MCS 15)</b>
151	(149, 153)			
153		10.5	10.5	
157		10.5	10.5	
159	(157, 161)			
161		10.0	10.0	
165		10.0	10.0	

Internal antenna, peak gain = 10.5dBi

## 16.6 Japan Regulatory Domain 2.4 GHz Band

### 16.6.1 Dipole Omni Antenna Model

The following is a transmit power table (Japan domain) per dipole omni antenna in the 2.4 GHz band:

<b>20 MHZ CHANNEL</b>	<b>40 MHZ CHANNEL</b>	<b>LEGACY DSSS RATES (1, 2, 5.5, 11 MBPS)</b>	<b>LEGACY OFDM RATES (6,9,12,18,24,36, 48,54 MBPS)</b>	<b>802.11n HT20 RATES (MCS 0 MCS 15)</b>	<b>802.11n HT40 RATES (MCS 0 MCS15)</b>
1		16.5	13.0	13.5	
2		16.5	13.0	13.5	
3	(1, 5)	16.5	13.0	13.5	13.5
4	(2, 6)	16.5	13.0	13.5	13.5
5	(3, 7)	16.5	13.0	13.5	13.5
6	(4, 8)	16.5	13.0	13.5	13.5
7	(5, 9)	16.5	13.0	13.5	13.5
8	(6, 10)	16.5	13.0	13.5	13.5
9	(7, 11)	16.5	13.0	13.5	13.5
10	(8, 12)	16.5	13.0	13.5	
11	(9, 13)	16.5	13.0	13.5	
12		16.5	13.0	13.5	
13		16.5	13.0	13.5	

Internal antenna, peak gain = 8.0dBi

## 16.7 Japan Regulatory Domain 5 GHz Band

### 16.7.1 Dipole Omni Antenna Model

The following is a transmit power table (Japan domain) per dipole omni antenna in the 5 GHz band:

<b>20 MHZ CHANNEL</b>	<b>40 MHZ CHANNEL</b>	<b>LEGACY OFDM RATES (6,9,12,18,24,36,48,54 MBPS)</b>	<b>802.11n HT20 RATES (MCS 0 MCS 15)</b>	<b>802.11n HT40 RATES (MCS 0 MCS 15)</b>
36		10.0	10.5	
38	(36, 40)			11.0
40		10.0	10.5	
44		10.0	10.5	
46	(44, 48)			11.0
48		10.0	10.5	
52		10.0	10.5	
54	(52, 56)			10.5
56		10.0	10.5	
60		10.0	10.5	
62	(60, 64)			10.5
64		10.0	10.5	
100		15.0	15.5	
102	(100, 104)			16.0
104		15.0	15.5	
108		15.0	15.5	
110				16.0
112	(108, 112)	15.0	15.5	
116		15.0	15.5	
118	(116, 120)			16.0
120		15.0	15.5	
124		15.0	15.5	
126	(124, 128)			16.0
128		15.0	15.5	
132		15.0	15.5	
134	(132, 136)			16.0
136		15.0	15.5	
140		15.0	15.5	
149				
151	(149, 153)			

<b>20 MHZ CHANNEL</b>	<b>40 MHZ CHANNEL</b>	<b>LEGACY OFDM RATES (6,9,12,18,24,36,48,54 MBPS)</b>	<b>802.11n HT20 RATES (MCS 0 MCS 15)</b>	<b>802.11n HT40 RATES (MCS 0 MCS 15)</b>
153				
157				
159	(157, 161)			
161				
165				

Internal antenna, peak gain = 10.5dBi

## AP8132 Regulatory Domains

### 17.1 US Regulatory Domain 2.4 GHz Band

#### 17.1.1 External Dipole Antenna Maximum Conducted Transmit Power Settings

The following is a transmit power table (US domain) per external dipole antenna in the 2.4 GHz band:

<b>20 MHZ CHANNEL</b>	<b>40 MHZ CHANNEL</b>	<b>LEGACY DSSS RATES (1, 2, 5.5, 11 MBPS)</b>	<b>LEGACY OFDM RATES (6,9,12,18,24,36, 48,54 MBPS)</b>	<b>802.11n HT20 RATES (MCS 0 MCS 15)</b>	<b>802.11n HT40 RATES (MCS 0 MCS15)</b>
1		17.0	17.0	16.0	
2		17.0	17.0	17.0	
3	(1, 5)	18.0	21.0	21.0	13.0
4	(2, 6)	18.0	21.0	21.0	13.0
5	(3, 7)	18.0	21.0	21.0	19.0
6	(4, 8)	18.0	21.0	21.0	19.0
7	(5, 9)	18.0	21.0	21.0	19.0
8	(6, 10)	18.0	21.0	21.0	10.0
9	(7, 11)	18.0	21.0	21.0	10.0
10		18.0	17.0	17.0	
11		18.0	17.0	17.0	

External dipole antenna, peak gain = 10.5dBi

### 17.1.2 External Panel Antenna Maximum Conducted Transmit Power Settings

The following is a transmit power table (US domain) per external panel antenna in the 2.4 GHz band:

<b>20 MHZ CHANNEL</b>	<b>40 MHZ CHANNEL</b>	<b>LEGACY DSSS RATES (1, 2, 5.5, 11 MBPS)</b>	<b>LEGACY OFDM RATES (6,9,12,18,24,36, 48,54 MBPS)</b>	<b>802.11n HT20 RATES (MCS 0 MCS 15)</b>	<b>802.11n HT40 RATES (MCS 0 MCS15)</b>
1		12.0	13.0	13.0	
2		17.0	17.0	17.0	
3	(1, 5)	17.0	17.0	17.0	10.0
4	(2, 6)	17.0	17.0	17.0	10.0
5	(3, 7)	17.0	17.0	17.0	14.0
6	(4, 8)	17.0	17.0	17.0	14.0
7	(5, 9)	17.0	17.0	17.0	14.0
8	(6, 10)	17.0	17.0	17.0	6.0
9	(7, 11)	17.0	17.0	17.0	6.0
10		17.0	17.0	17.0	
11		16.0	15.0	15.0	

External Panel antenna, peak gain = 15dBi



### 17.1.3 External Yagi Antenna Maximum Conducted Transmit Power Settings

The following is a transmit power table (US domain) per external yagi antenna in the 2.4 GHz band:

<b>20 MHZ CHANNEL</b>	<b>40 MHZ CHANNEL</b>	<b>LEGACY DSSS RATES (1, 2, 5.5, 11 MBPS)</b>	<b>LEGACY OFDM RATES (6,9,12,18,24,36, 48,54 MBPS)</b>	<b>802.11n HT20 RATES (MCS 0 MCS 15)</b>	<b>802.11n HT40 RATES (MCS 0 MCS15)</b>
1		8.0	9.0	9.0	
2		8.0	13.0	13.0	
3	(1, 5)	17.0	13.0	13.0	9.0
4	(2, 6)	17.0	13.0	13.0	9.0
5	(3, 7)	17.0	13.0	13.0	12.0
6	(4, 8)	17.0	13.0	13.0	12.0
7	(5, 9)	17.0	13.0	13.0	12.0
8	(6, 10)	17.0	13.0	13.0	6.0
9	(7, 11)	17.0	13.0	13.0	6.0
10		6.0	13.0	13.0	
11		6.0	13.0	13.0	

External yagi antenna, peak gain = 14.5dBi

### 17.1.4 External Patch Antenna Maximum Conducted Transmit Power Settings

The following is a transmit power table (US domain) per external patch antenna in the 2.4 GHz band:

<b>20 MHZ CHANNEL</b>	<b>40 MHZ CHANNEL</b>	<b>LEGACY DSSS RATES (1, 2, 5.5, 11 MBPS)</b>	<b>LEGACY OFDM RATES (6,9,12,18,24,36, 48,54 MBPS)</b>	<b>802.11n HT20 RATES (MCS 0 MCS 15)</b>	<b>802.11n HT40 RATES (MCS 0 MCS15)</b>
1		20.0	17.0	17.0	
2		23.0	23.0	23.0	
3	(1, 5)	23.0	23.0	23.0	13.0
4	(2, 6)	23.0	23.0	23.0	13.0
5	(3, 7)	23.0	23.0	23.0	18.0
6	(4, 8)	23.0	23.0	23.0	18.0
7	(5, 9)	23.0	23.0	23.0	18.0
8	(6, 10)	23.0	23.0	23.0	14.0
9	(7, 11)	23.0	23.0	23.0	14.0
10		23.0	23.0	23.0	
11		19.0	17.0	17.0	

External patch antenna, peak gain = 4dBi

### 17.1.5 Facade Antenna Maximum Conducted Transmit Power Settings

The following is a transmit power table (US domain) per internal facade antenna in the 2.4 GHz band:

<b>20 MHZ CHANNEL</b>	<b>40 MHZ CHANNEL</b>	<b>LEGACY DSSS RATES (1, 2, 5.5, 11 MBPS)</b>	<b>LEGACY OFDM RATES (6,9,12,18,24,36, 48,54 MBPS)</b>	<b>802.11n HT20 RATES (MCS 0 MCS 15)</b>	<b>802.11n HT40 RATES (MCS 0 MCS15)</b>
1		20.0	18.0	18.0	
2		23.0	23.0	23.0	
3	(1, 5)	23.0	23.0	23.0	14.0
4	(2, 6)	23.0	23.0	23.0	18.0
5	(3, 7)	23.0	23.0	23.0	18.0
6	(4, 8)	23.0	23.0	23.0	18.0
7	(5, 9)	23.0	23.0	23.0	18.0
8	(6, 10)	23.0	23.0	23.0	18.0
9	(7, 11)	23.0	23.0	23.0	14.0
10		23.0	23.0	23.0	
11		20.0	19.0	19.0	

Facade antenna, peak gain = 3.5dBi

## 17.2 US Regulatory Domain 5 GHz Band

### 17.2.1 External Dipole Antenna Model

The following is a transmit power table (US domain) per external dipole antenna in the 5 GHz band:

<b>20 MHZ CHANNEL</b>	<b>40 MHZ CHANNEL</b>	<b>LEGACY OFDM RATES (6,9,12,18,24,36,48,54 MBPS)</b>	<b>802.11n HT20 RATES (MCS 0 MCS 15)</b>	<b>802.11n HT40 RATES (MCS 0 MCS 15)</b>
36		8.0	8.0	
38	(36, 40)	8.0	8.0	8.0
40		8.0	8.0	
44		8.0	8.0	
46	(44, 48)	8.0	8.0	9.0
48		8.0	8.0	
52		15.0	16.0	
54	(52, 56)	15.0	15.0	16.0
56		15.0	15.0	
60		15.0	15.0	
62	(60, 64)	15.0	15.0	15.0
64		15.0	15.0	
100		15.0	15.0	
102	(100, 104)	15.0	15.0	11.5
104		15.0	15.0	
108		15.0	15.0	
110		15.0	15.0	15.0
112		15.0	15.0	
116		15.0	15.0	
118	(116, 120)	15.0	15.0	15.0
120		15.0	15.0	
124		15.0	15.0	
126	(124, 128)	15.0	15.0	16.0
128		15.0	15.0	
132		15.0	15.0	
134	(132, 136)	15.0	15.0	16.0
136		15.0	15.0	
140		14.0	14.0	
149		20.0	20.0	

<b>20 MHZ CHANNEL</b>	<b>40 MHZ CHANNEL</b>	<b>LEGACY OFDM RATES (6,9,12,18,24,36,48,54 MBPS)</b>	<b>802.11n HT20 RATES (MCS 0 MCS 15)</b>	<b>802.11n HT40 RATES (MCS 0 MCS 15)</b>
151	(149, 153)	20.0	20.0	20.0
153		20.0	20.0	
157		20.0	20.0	
159	(157, 161)	20.0	20.0	20.0
161		20.0	20.0	
165		20.0	20.0	

External dipole antenna, peak gain = 10.5dBi

## 17.2.2 External Panel Antenna Model

The following is a transmit power table (US domain) per external panel antenna in the 5 GHz band:

<b>20 MHZ CHANNEL</b>	<b>40 MHZ CHANNEL</b>	<b>LEGACY OFDM RATES (6,9,12,18,24,36,48,54 MBPS)</b>	<b>802.11n HT20 RATES (MCS 0 MCS 15)</b>	<b>802.11n HT40 RATES (MCS 0 MCS 15)</b>
36		4.0	4.0	
38	(36, 40)	4.0	4.0	4.0
40		4.0	4.0	
44		4.0	4.0	
46	(44, 48)	4.0	4.0	4.0
48		4.0	4.0	
52		4.0	4.0	
54	(52, 56)	4.0	4.0	4.0
56		4.0	4.0	
60		4.0	4.0	
62	(60, 64)	4.0	4.0	4.0
64		4.0	4.0	
100		4.0	4.0	
102	(100, 104)	4.0	4.0	4.0
104		4.0	4.0	
108		4.0	4.0	
110		4.0	4.0	6.0
112		4.0	4.0	
116		4.0	4.0	
118	(116, 120)	4.0	4.0	4.0
120		4.0	4.0	
124		4.0	4.0	
126	(124, 128)	4.0	4.0	4.0
128		4.0	4.0	
132		4.0	4.0	
134	(132, 136)	4.0	4.0	4.0
136		4.0	4.0	
140		4.0	4.0	
149		20.0	20.0	
151	(149, 153)	20.0	20.0	20.0
153		20.0	20.0	
157		20.0	20.0	

<b>20 MHZ CHANNEL</b>	<b>40 MHZ CHANNEL</b>	<b>LEGACY OFDM RATES (6,9,12,18,24,36,48,54 MBPS)</b>	<b>802.11n HT20 RATES (MCS 0 MCS 15)</b>	<b>802.11n HT40 RATES (MCS 0 MCS 15)</b>
159	(157, 161)	20.0	20.0	20.0
161		20.0	20.0	
165		20.0	20.0	

External panel antenna, peak gain = 12dBi

### 17.2.3 External Yagi Antenna Model

The following is a transmit power table (US domain) per external yagi antenna in the 5 GHz band:

<b>20 MHZ CHANNEL</b>	<b>40 MHZ CHANNEL</b>	<b>LEGACY OFDM RATES (6,9,12,18,24,36,48,54 MBPS)</b>	<b>802.11n HT20 RATES (MCS 0 MCS 15)</b>	<b>802.11n HT40 RATES (MCS 0 MCS 15)</b>
36		8.0	8.0	
38	(36, 40)	8.0	8.0	8.0
40		8.0	8.0	
44		8.0	8.0	
46	(44, 48)	8.0	8.0	8.0
48		8.0	8.0	
52		12.0	12.0	
54	(52, 56)	3.0	3.5	11.5
56		3.0	3.5	
60		3.0	3.5	
62	(60, 64)	3.0	3.5	9.0
64		3.0	3.5	
100		6.5	7.0	
102	(100, 104)	6.5	7.0	7.0
104		15.0	15.0	
108		15.0	15.0	
110		15.0	15.0	7.5
112	(108, 112)	15.0	15.0	
116		15.0	15.0	
118	(116, 120)	15.0	15.0	6.5
120		15.0	15.0	
124		15.0	15.0	
126	(124, 128)	15.0	15.0	6.5
128		15.0	15.0	
132		15.0	15.0	
134	(132, 136)	15.0	15.0	10.0
136		4.0	3.5	
140		4.0	3.5	
149		20.0	20.0	
151	(149, 153)	20.0	20.0	20.0



<b>20 MHZ CHANNEL</b>	<b>40 MHZ CHANNEL</b>	<b>LEGACY OFDM RATES (6,9,12,18,24,36,48,54 MBPS)</b>	<b>802.11n HT20 RATES (MCS 0 MCS 15)</b>	<b>802.11n HT40 RATES (MCS 0 MCS 15)</b>
153		20.0	20.0	
157		20.0	20.0	
159	(157, 161)	20.0	20.0	20.0
161		20.0	20.0	
165		20.0	20.0	

Panel antenna, peak gain = 10.5dBi

## 17.2.4 External Patch Antenna Model

The following is a transmit power table (US domain) per external patch antenna in the 5 GHz band:

<b>20 MHZ CHANNEL</b>	<b>40 MHZ CHANNEL</b>	<b>LEGACY OFDM RATES (6,9,12,18,24,36,48,54 MBPS)</b>	<b>802.11n HT20 RATES (MCS 0 MCS 15)</b>	<b>802.11n HT40 RATES (MCS 0 MCS 15)</b>
36		15.0	15.0	
38	(36, 40)	15.0	15.0	13.0
40		15.0	15.0	
44		15.0	15.0	
46	(44, 48)	15.0	15.0	13.0
48		15.0	15.0	
52		18.0	18.0	
54	(52, 56)	18.0	18.0	20.0
56		18.0	18.0	
60		18.0	18.0	
62	(60, 64)	18.0	18.0	17.5
64		18.0	18.0	
100		17.0	17.0	
102	(100, 104)	17.0	17.0	14.5
104		20.0	20.0	
108		20.0	20.0	
110		20.0	20.0	20.0
112	(108, 112)	20.0	20.0	
116		20.0	20.0	
118	(116, 120)	20.0	20.0	19.5
120		20.0	20.0	
124		20.0	20.0	
126	(124, 128)	20.0	20.0	20.0
128		20.0	20.0	
132		20.0	20.0	
134	(132, 136)	20.0	20.0	19.5
136		17.0	17.0	
140		17.0	17.0	
149		20.0	20.0	
151	(149, 153)	20.0	20.0	20.0

<b>20 MHZ CHANNEL</b>	<b>40 MHZ CHANNEL</b>	<b>LEGACY OFDM RATES (6,9,12,18,24,36,48,54 MBPS)</b>	<b>802.11n HT20 RATES (MCS 0 MCS 15)</b>	<b>802.11n HT40 RATES (MCS 0 MCS 15)</b>
153		20.0	20.0	
157		20.0	20.0	
159	(157, 161)	20.0	20.0	20.0
161		20.0	20.0	
165		20.0	20.0	

External patch antenna, peak gain = 3.8dBi

## 17.2.5 Facade Antenna Model

The following is a transmit power table (US domain) per external facade antenna in the 5 GHz band:

<b>20 MHZ CHANNEL</b>	<b>40 MHZ CHANNEL</b>	<b>LEGACY OFDM RATES (6,9,12,18,24,36,48,54 MBPS)</b>	<b>802.11n HT20 RATES (MCS 0 MCS 15)</b>	<b>802.11n HT40 RATES (MCS 0 MCS 15)</b>
36		14.0	14.0	
38	(36, 40)	14.0	14.0	14.0
40		14.0	14.0	
44		14.0	14.0	
46	(44, 48)	14.0	14.0	14.0
48		14.0	14.0	
52		20.0	20.0	
54	(52, 56)	20.0	20.0	18.0
56		20.0	20.0	
60		20.0	20.0	
62	(60, 64)	20.0	20.0	18.0
64		20.0	20.0	
100		18.0	18.0	
102	(100, 104)	17.0	17.0	20.0
104		20.0	20.0	
108		20.0	20.0	
110		20.0	20.0	18.5
112	(108, 112)	20.0	20.0	
116		20.0	20.0	
118	(116, 120)	20.0	20.0	15.0
120		20.0	20.0	
124		20.0	20.0	
126	(124, 128)	20.0	20.0	20.0
128		20.0	20.0	
132		20.0	20.0	
134	(132, 136)	20.0	20.0	20.0
136		20.0	20.0	
140		17.0	17.0	
149		20.0	20.0	
151	(149, 153)	20.0	20.0	20.0

<b>20 MHZ CHANNEL</b>	<b>40 MHZ CHANNEL</b>	<b>LEGACY OFDM RATES (6,9,12,18,24,36,48,54 MBPS)</b>	<b>802.11n HT20 RATES (MCS 0 MCS 15)</b>	<b>802.11n HT40 RATES (MCS 0 MCS 15)</b>
153		20.0	20.0	
157		20.0	20.0	
159	(157, 161)	20.0	20.0	20.0
161		20.0	20.0	
165		20.0	20.0	

Facade antenna, peak gain = 4.0dBi

## 17.3 EU Regulatory Domain 2.4 GHz Band

### 17.3.1 External Dipole Antenna Model

The following is a transmit power table (EU domain) per external dipole antenna in the 2.4 GHz band:

<b>20 MHZ CHANNEL</b>	<b>40 MHZ CHANNEL</b>	<b>LEGACY DSSS RATES (1, 2, 5.5, 11 MBPS)</b>	<b>LEGACY OFDM RATES (6,9,12,18,24,36, 48,54 MBPS)</b>	<b>802.11n HT20 RATES (MCS 0 MCS 15)</b>	<b>802.11n HT40 RATES (MCS 0 MCS15)</b>
1		4.5	4.5	4.5	
2		4.5	4.5	4.5	
3	(1, 5)	4.5	4.5	4.5	4.5
4	(2, 6)	4.5	4.5	4.5	4.5
5	(3, 7)	4.5	4.5	4.5	4.5
6	(4, 8)	4.5	4.5	4.5	4.5
7	(5, 9)	4.5	4.5	4.5	4.5
8	(6, 10)	4.5	4.5	4.5	4.5
9	(7, 11)	4.5	4.5	4.5	4.5
10	(8, 12)	4.5	4.5	4.5	4.5
11	(9, 13)	4.5	4.5	4.5	4.5
12		4.5	4.5	4.5	
13		4.5	4.5	4.5	
14					

External dipole antenna, peak gain = 10.5dBi

### 17.3.2 External Panel Antenna Model

The following is a transmit power table (EU domain) per external panel antenna in the 2.4 GHz band:

<b>20 MHZ CHANNEL</b>	<b>40 MHZ CHANNEL</b>	<b>LEGACY DSSS RATES (1, 2, 5.5, 11 MBPS)</b>	<b>LEGACY OFDM RATES (6,9,12,18,24,36, 48,54 MBPS)</b>	<b>802.11n HT20 RATES (MCS 0 MCS 15)</b>	<b>802.11n HT40 RATES (MCS 0 MCS15)</b>
1		7.0	7.0	7.0	
2		7.0	7.0	7.0	
3	(1, 5)	7.0	7.0	7.0	7.0
4	(2, 6)	7.0	7.0	7.0	7.0
5	(3, 7)	7.0	7.0	7.0	7.0
6	(4, 8)	7.0	7.0	7.0	7.0
7	(5, 9)	7.0	7.0	7.0	7.0
8	(6, 10)	7.0	7.0	7.0	7.0
9	(7, 11)	7.0	7.0	7.0	7.0
10	(8, 12)	7.0	7.0	7.0	7.0
11	(9, 13)	7.0	7.0	7.0	7.0
12		7.0	7.0	7.0	
13		7.0	7.0	7.0	
14					

External panel antenna, peak gain = 8dBi

### 17.3.3 External Patch Antenna Model

The following is a transmit power table (EU domain) per external patch antenna in the 2.4 GHz band:

<b>20 MHZ CHANNEL</b>	<b>40 MHZ CHANNEL</b>	<b>LEGACY DSSS RATES (1, 2, 5.5, 11 MBPS)</b>	<b>LEGACY OFDM RATES (6,9,12,18,24,36, 48,54 MBPS)</b>	<b>802.11n HT20 RATES (MCS 0 MCS 15)</b>	<b>802.11n HT40 RATES (MCS 0 MCS15)</b>
1		11.0	11.0	11.0	
2		11.0	11.0	11.0	
3	(1, 5)	11.0	11.0	11.0	11.0
4	(2, 6)	11.0	11.0	11.0	11.0
5	(3, 7)	11.0	11.0	11.0	11.0
6	(4, 8)	11.0	11.0	11.0	11.0
7	(5, 9)	11.0	11.0	11.0	11.0
8	(6, 10)	11.0	11.0	11.0	11.0
9	(7, 11)	11.0	11.0	11.0	11.0
10		11.0	11.0	11.0	
11		11.0	11.0	11.0	
12					
13					
14					

External patch antenna, peak gain = 4dBi



### 17.3.4 Facade Antenna Model

The following is a transmit power table (EU domain) per internal facade antenna in the 2.4 GHz band:

<b>20 MHZ CHANNEL</b>	<b>40 MHZ CHANNEL</b>	<b>LEGACY DSSS RATES (1, 2, 5.5, 11 MBPS)</b>	<b>LEGACY OFDM RATES (6,9,12,18,24,36, 48,54 MBPS)</b>	<b>802.11n HT20 RATES (MCS 0 MCS 15)</b>	<b>802.11n HT40 RATES (MCS 0 MCS15)</b>
1		11.5	11.5	11.5	
2		11.5	11.5	11.5	
3	(1, 5)	11.5	11.5	11.5	11.5
4	(2, 6)	11.5	11.5	11.5	11.5
5	(3, 7)	11.5	11.5	11.5	11.5
6	(4, 8)	11.5	11.5	11.5	11.5
7	(5, 9)	11.5	11.5	11.5	11.5
8	(6, 10)	11.5	11.5	11.5	11.5
9	(7, 11)	11.5	11.5	11.5	11.5
10		11.5	11.5	11.5	
11		11.5	11.5	11.5	
12					
13					
14					

Facade antenna, peak gain = 3.5dBi

## 17.4 EU Regulatory Domain 5 GHz Band

### 17.4.1 External Dipole Antenna Model

The following is a transmit power table (EU domain) per external dipole antenna in the 5 GHz band:

<b>20 MHZ CHANNEL</b>	<b>40 MHZ CHANNEL</b>	<b>LEGACY OFDM RATES (6,9,12,18,24,36,48,54 MBPS)</b>	<b>802.11n HT20 RATES (MCS 0 MCS 15)</b>	<b>802.11n HT40 RATES (MCS 0 MCS 15)</b>
36		7.5	7.5	
38	(36, 40)	7.5	7.5	7.5
40		7.5	7.5	
44		7.5	7.5	
46	(44, 48)	7.5	7.5	7.5
48		7.5	7.5	
52		7.5	7.5	
54	(52, 56)	7.5	7.5	7.5
56		7.5	7.5	
60		7.5	7.5	
62	(60, 64)	7.5	7.5	7.5
64		7.5	7.5	
100		14.5	14.5	
102	(100, 104)	14.5	14.5	14.5
104		14.5	14.5	
108		14.5	14.5	
110		14.5	14.5	14.5
112	(108, 112)	14.5	14.5	
116		14.5	14.5	
118	(116, 120)	14.5	14.5	14.5
120		14.5	14.5	
124		14.5	14.5	
126	(124, 128)	14.5	14.5	14.5
128		14.5	14.5	
132		14.5	14.5	
134	(132, 136)	14.5	14.5	14.5
136		14.5	14.5	
140		14.5	14.5	
149				

<b>20 MHZ CHANNEL</b>	<b>40 MHZ CHANNEL</b>	<b>LEGACY OFDM RATES (6,9,12,18,24,36,48,54 MBPS)</b>	<b>802.11n HT20 RATES (MCS 0 MCS 15)</b>	<b>802.11n HT40 RATES (MCS 0 MCS 15)</b>
151	(149, 153)			
153				
157				
159	(157, 161)			
161				
165				

External dipole antenna, peak gain = 10.5dBi

## 17.4.2 External Panel Antenna Model

The following is a transmit power table (EU domain) per external panel antenna in the 5 GHz band:

<b>20 MHZ CHANNEL</b>	<b>40 MHZ CHANNEL</b>	<b>LEGACY OFDM RATES (6,9,12,18,24,36,48,54 MBPS)</b>	<b>802.11n HT20 RATES (MCS 0 MCS 15)</b>	<b>802.11n HT40 RATES (MCS 0 MCS 15)</b>
36		4.0	4.0	
38	(36, 40)	4.0	4.0	4.0
40		4.0	4.0	
44		4.0	4.0	
46	(44, 48)	4.0	4.0	4.0
48		4.0	4.0	
52		4.0	4.0	
54	(52, 56)	4.0	4.0	4.0
56		4.0	4.0	
60		4.0	4.0	
62	(60, 64)	4.0	4.0	4.0
64		4.0	4.0	
100		11.0	11.0	
102	(100, 104)	11.0	11.0	11.0
104		11.0	11.0	
108		11.0	11.0	
110		11.0	11.0	11.0
112	(108, 112)	11.0	11.0	
116		11.0	11.0	
118	(116, 120)	11.0	11.0	11.0
120		11.0	11.0	
124		11.0	11.0	
126	(124, 128)	11.0	11.0	11.0
128		11.0	11.0	
132		11.0	11.0	
134	(132, 136)	11.0	11.0	11.0
136		11.0	11.0	
140		11.0	11.0	
149				
151	(149, 153)			

<b>20 MHZ CHANNEL</b>	<b>40 MHZ CHANNEL</b>	<b>LEGACY OFDM RATES (6,9,12,18,24,36,48,54 MBPS)</b>	<b>802.11n HT20 RATES (MCS 0 MCS 15)</b>	<b>802.11n HT40 RATES (MCS 0 MCS 15)</b>
153				
157				
159	(157, 161)			
161				
165				

External panel antenna, peak gain = 14dBi

### 17.4.3 External Yagi Antenna Model

The following is a transmit power table (EU domain) per external yagi antenna in the 5 GHz band:

<b>20 MHZ CHANNEL</b>	<b>40 MHZ CHANNEL</b>	<b>LEGACY OFDM RATES (6,9,12,18,24,36,48,54 MBPS)</b>	<b>802.11n HT20 RATES (MCS 0 MCS 15)</b>	<b>802.11n HT40 RATES (MCS 0 MCS 15)</b>
36		7.5	6.0	
38	(36, 40)	7.5	7.5	7.5
40		7.5	7.5	
44		7.5	7.5	
46	(44, 48)	7.5	7.5	7.5
48		7.5	7.5	
52		7.5	7.5	
54	(52, 56)	7.5	7.5	7.5
56		7.5	7.5	
60		7.5	7.5	
62	(60, 64)	7.5	7.5	7.5
64		7.5	7.5	
100		14.5	14.5	
102	(100, 104)	14.5	14.5	14.5
104		14.5	14.5	
108		14.5	14.5	
110		14.5	14.5	14.5
112	(108, 112)	14.5	14.5	
116		14.5	14.5	
118	(116, 120)	14.5	14.5	14.5
120		14.5	14.5	
124		14.5	14.5	
126	(124, 128)	14.5	14.5	14.5
128		14.5	14.5	
132		14.5	14.5	
134	(132, 136)	14.5	14.5	14.5
136		14.5	14.5	
140		14.5	14.5	
149				
151	(149, 153)			

<b>20 MHZ CHANNEL</b>	<b>40 MHZ CHANNEL</b>	<b>LEGACY OFDM RATES (6,9,12,18,24,36,48,54 MBPS)</b>	<b>802.11n HT20 RATES (MCS 0 MCS 15)</b>	<b>802.11n HT40 RATES (MCS 0 MCS 15)</b>
153				
157				
159	(157, 161)			
161				
165				

External yagi antenna, peak gain = 10.5dBi

### 17.4.4 External Patch Antenna Model

The following is a transmit power table (EU domain) per external patch antenna in the 5 GHz band:

<b>20 MHZ CHANNEL</b>	<b>40 MHZ CHANNEL</b>	<b>LEGACY OFDM RATES (6,9,12,18,24,36,48,54 MBPS)</b>	<b>802.11n HT20 RATES (MCS 0 MCS 15)</b>	<b>802.11n HT40 RATES (MCS 0 MCS 15)</b>
36		14.5	14.5	
38	(36, 40)	14.5	14.5	14.5
40		14.5	14.5	
44		14.5	14.5	
46	(44, 48)	14.5	14.5	14.5
48		14.5	14.5	
52		14.5	14.5	
54	(52, 56)	14.5	14.5	14.5
56		14.5	14.5	
60		14.5	14.5	
62	(60, 64)	14.5	14.5	14.5
64		14.5	14.5	
100		20.0	20.0	
102	(100, 104)	20.0	20.0	20.0
104		20.0	20.0	
108		20.0	20.0	
110		20.0	20.0	20.0
112	(108, 112)	20.0	20.0	
116		20.0	20.0	
118	(116, 120)	20.0	20.0	20.0
120		20.0	20.0	
124		20.0	20.0	
126	(124, 128)	20.0	20.0	20.0
128		20.0	20.0	
132		20.0	20.0	
134	(132, 136)	20.0	20.0	20.0
136		20.0	20.0	
140		20.0	20.0	
149				
151	(149, 153)			



<b>20 MHZ CHANNEL</b>	<b>40 MHZ CHANNEL</b>	<b>LEGACY OFDM RATES (6,9,12,18,24,36,48,54 MBPS)</b>	<b>802.11n HT20 RATES (MCS 0 MCS 15)</b>	<b>802.11n HT40 RATES (MCS 0 MCS 15)</b>
153				
157				
159	(157, 161)			
161				
165				

External patch antenna, peak gain = 3.8dBi

### 17.4.5 Facade Antenna Model

The following is a transmit power table (EU domain) per external facade antenna in the 5 GHz band:

<b>20 MHZ CHANNEL</b>	<b>40 MHZ CHANNEL</b>	<b>LEGACY OFDM RATES (6,9,12,18,24,36,48,54 MBPS)</b>	<b>802.11n HT20 RATES (MCS 0 MCS 15)</b>	<b>802.11n HT40 RATES (MCS 0 MCS 15)</b>
36		14.0	14.0	
38	(36, 40)	14.0	14.0	14.0
40		14.0	14.0	
44		14.0	14.0	
46	(44, 48)	14.0	14.0	14.0
48		14.0	14.0	
52		14.0	14.0	
54	(52, 56)	14.0	14.0	14.0
56		14.0	14.0	
60		14.0	14.0	
62	(60, 64)	14.0	14.0	14.0
64		14.0	14.0	
100		20.0	20.0	
102	(100, 104)	20.0	20.0	20.0
104		20.0	20.0	
108		20.0	20.0	
110		20.0	20.0	20.0
112	(108, 112)	20.0	20.0	
116		20.0	20.0	
118	(116, 120)	20.0	20.0	20.0
120		20.0	20.0	
124		20.0	20.0	
126	(124, 128)	20.0	20.0	20.0
128		20.0	20.0	
132		20.0	20.0	
134	(132, 136)	20.0	20.0	20.0
136		20.0	20.0	
140		20.0	20.0	
149				
151	(149, 153)			

<b>20 MHZ CHANNEL</b>	<b>40 MHZ CHANNEL</b>	<b>LEGACY OFDM RATES (6,9,12,18,24,36,48,54 MBPS)</b>	<b>802.11n HT20 RATES (MCS 0 MCS 15)</b>	<b>802.11n HT40 RATES (MCS 0 MCS 15)</b>
153				
157				
159	(157, 161)			
161				
165				

Facade antenna, peak gain = 4dBi

## 17.5 Japan Regulatory Domain 2.4 GHz Band

### 17.5.1 External Dipole Antenna Model

The following is a transmit power table (Japan domain) per external dipole antenna in the 2.4 GHz band:

<b>20 MHZ CHANNEL</b>	<b>40 MHZ CHANNEL</b>	<b>LEGACY DSSS RATES (1, 2, 5.5, 11 MBPS)</b>	<b>LEGACY OFDM RATES (6,9,12,18,24,36, 48,54 MBPS)</b>	<b>802.11n HT20 RATES (MCS 0 MCS 15)</b>	<b>802.11n HT40 RATES (MCS 0 MCS15)</b>
1		8.0	9.0	9.0	
2		8.0	9.0	9.0	
3	(1, 5)	8.0	9.0	9.0	9.0
4	(2, 6)	8.0	9.0	9.0	9.0
5	(3, 7)	8.0	9.0	9.0	9.0
6	(4, 8)	8.0	9.0	9.0	9.0
7	(5, 9)	8.0	9.0	9.0	9.0
8	(6, 10)	8.0	9.0	9.0	9.0
9	(7, 11)	8.0	9.0	9.0	9.0
10	(8, 12)	8.0	9.0	9.0	9.0
11	(9, 13)	8.0	9.0	9.0	9.0
12		8.0	9.0	9.0	
13		8.0	9.0	9.0	
14					

External dipole antenna, peak gain = 10.5dBi

## 17.5.2 External Panel Antenna Model

The following is a transmit power table (Japan domain) per external panel antenna in the 2.4 GHz band:

<b>20 MHZ CHANNEL</b>	<b>40 MHZ CHANNEL</b>	<b>LEGACY DSSS RATES (1, 2, 5.5, 11 MBPS)</b>	<b>LEGACY OFDM RATES (6,9,12,18,24,36, 48,54 MBPS)</b>	<b>802.11n HT20 RATES (MCS 0 MCS 15)</b>	<b>802.11n HT40 RATES (MCS 0 MCS15)</b>
1		13.0	14.0	14.0	
2		13.0	14.0	14.0	
3	(1, 5)	13.0	14.0	14.0	14.0
4	(2, 6)	13.0	14.0	14.0	14.0
5	(3, 7)	13.0	14.0	14.0	14.0
6	(4, 8)	13.0	14.0	14.0	14.0
7	(5, 9)	13.0	14.0	14.0	14.0
8	(6, 10)	13.0	14.0	14.0	14.0
9	(7, 11)	13.0	14.0	14.0	14.0
10	(8, 12)	13.0	14.0	14.0	14.0
11	(9, 13)	13.0	14.0	14.0	14.0
12		13.0	14.0	14.0	
13		13.0	14.0	14.0	
14					

External panel antenna, peak gain = 15dBi

### 17.5.3 External Yagi Antenna Model

The following is a transmit power table (Japan domain) per external yagi antenna in the 2.4 GHz band:

<b>20 MHZ CHANNEL</b>	<b>40 MHZ CHANNEL</b>	<b>LEGACY DSSS RATES (1, 2, 5.5, 11 MBPS)</b>	<b>LEGACY OFDM RATES (6,9,12,18,24,36, 48,54 MBPS)</b>	<b>802.11n HT20 RATES (MCS 0 MCS 15)</b>	<b>802.11n HT40 RATES (MCS 0 MCS15)</b>
1		14.0	15.0	15.0	
2		14.0	15.0	15.0	
3	(1, 5)	14.0	15.0	15.0	15.0
4	(2, 6)	14.0	15.0	15.0	15.0
5	(3, 7)	14.0	15.0	15.0	15.0
6	(4, 8)	14.0	15.0	15.0	15.0
7	(5, 9)	14.0	15.0	15.0	15.0
8	(6, 10)	14.0	15.0	15.0	15.0
9	(7, 11)	14.0	15.0	15.0	15.0
10		14.0	15.0	15.0	15.0
11		14.0	15.0	15.0	15.0
12		14.0	15.0	15.0	
13		14.0	15.0	15.0	
14					

External patch antenna, peak gain = 14.5dBi

### 17.5.4 External Patch Antenna Model

The following is a transmit power table (Japan domain) per external patch antenna in the 2.4 GHz band:

<b>20 MHZ CHANNEL</b>	<b>40 MHZ CHANNEL</b>	<b>LEGACY DSSS RATES (1, 2, 5.5, 11 MBPS)</b>	<b>LEGACY OFDM RATES (6,9,12,18,24,36, 48,54 MBPS)</b>	<b>802.11n HT20 RATES (MCS 0 MCS 15)</b>	<b>802.11n HT40 RATES (MCS 0 MCS15)</b>
1		14.0	15.0	15.0	
2		14.0	15.0	15.0	
3	(1, 5)	14.0	15.0	15.0	15.0
4	(2, 6)	14.0	15.0	15.0	15.0
5	(3, 7)	14.0	15.0	15.0	15.0
6	(4, 8)	14.0	15.0	15.0	15.0
7	(5, 9)	14.0	15.0	15.0	15.0
8	(6, 10)	14.0	15.0	15.0	15.0
9	(7, 11)	14.0	15.0	15.0	15.0
10		14.0	15.0	15.0	
11		14.0	15.0	15.0	
12					
13					
14					

External patch antenna, peak gain = 4dBi

### 17.5.5 Internal Facade Antenna Model

The following is a transmit power table (Japan domain) per internal facade antenna in the 2.4 GHz band:

<b>20 MHZ CHANNEL</b>	<b>40 MHZ CHANNEL</b>	<b>LEGACY DSSS RATES (1, 2, 5.5, 11 MBPS)</b>	<b>LEGACY OFDM RATES (6,9,12,18,24,36, 48,54 MBPS)</b>	<b>802.11n HT20 RATES (MCS 0 MCS 15)</b>	<b>802.11n HT40 RATES (MCS 0 MCS15)</b>
1		15.0	15.0	15.0	
2		15.0	15.0	15.0	
3	(1, 5)	15.0	15.0	15.0	15.0
4	(2, 6)	15.0	15.0	15.0	15.0
5	(3, 7)	15.0	15.0	15.0	15.0
6	(4, 8)	15.0	15.0	15.0	15.0
7	(5, 9)	15.0	15.0	15.0	15.0
8	(6, 10)	15.0	15.0	15.0	15.0
9	(7, 11)	15.0	15.0	15.0	15.0
10		15.0	15.0	15.0	
11		15.0	15.0	15.0	
12					
13					
14					

Facade antenna, peak gain = 3.4 dBi



## 17.6 Japan Regulatory Domain 5 GHz Band

### 17.6.1 External Dipole Antenna Model

The following is a transmit power table (Japan domain) per external dipole antenna in the 5 GHz band:

<b>20 MHZ CHANNEL</b>	<b>40 MHZ CHANNEL</b>	<b>LEGACY OFDM RATES (6,9,12,18,24,36,48,54 MBPS)</b>	<b>802.11n HT20 RATES (MCS 0 MCS 15)</b>	<b>802.11n HT40 RATES (MCS 0 MCS 15)</b>
36		7.0	7.0	
38	(36, 40)	7.0	7.0	7.0
40		7.0	7.0	
44		7.0	7.0	
46	(44, 48)	7.0	7.0	7.0
48		7.0	7.0	
52		7.0	7.0	
54	(52, 56)	7.0	7.0	7.0
56		7.0	7.0	
60		7.0	7.0	
62	(60, 64)	7.0	7.0	7.0
64		7.0	7.0	
100		14.0	14.0	
102	(100, 104)	14.0	14.0	14.0
104		14.0	14.0	
108		14.0	14.0	
110		14.0	14.0	14.0
112	(108, 112)	14.0	14.0	
116		14.0	14.0	
118	(116, 120)	14.0	14.0	14.0
120		14.0	14.0	
124		14.0	14.0	
126	(124, 128)	14.0	14.0	14.0
128		14.0	14.0	
132		14.0	14.0	
134	(132, 136)	14.0	14.0	14.0
136		14.0	14.0	
140		14.0	14.0	
149				

<b>20 MHZ CHANNEL</b>	<b>40 MHZ CHANNEL</b>	<b>LEGACY OFDM RATES (6,9,12,18,24,36,48,54 MBPS)</b>	<b>802.11n HT20 RATES (MCS 0 MCS 15)</b>	<b>802.11n HT40 RATES (MCS 0 MCS 15)</b>
151	(149, 153)			
153				
157				
159	(157, 161)			
161				
165				

External dipole antenna, peak gain = 10.5dBi

## 17.6.2 External Panel Antenna Model

The following is a transmit power table (Japan domain) per external panel antenna in the 5 GHz band:

<b>20 MHZ CHANNEL</b>	<b>40 MHZ CHANNEL</b>	<b>LEGACY OFDM RATES (6,9,12,18,24,36,48,54 MBPS)</b>	<b>802.11n HT20 RATES (MCS 0 MCS 15)</b>	<b>802.11n HT40 RATES (MCS 0 MCS 15)</b>
36		3.0	3.0	
38	(36, 40)	3.0	3.0	3.0
40		3.0	3.0	
44		3.0	3.0	
46	(44, 48)	3.0	3.0	3.0
48		3.0	3.0	
52		3.0	3.0	
54	(52, 56)	3.0	3.0	3.0
56		3.0	3.0	
60		3.0	3.0	
62	(60, 64)	3.0	3.0	3.0
64		3.0	3.0	
100		10.0	10.0	
102	(100, 104)	10.0	10.0	10.0
104		10.0	10.0	
108		10.0	10.0	
110		10.0	10.0	10.0
112	(108, 112)	10.0	10.0	
116		10.0	10.0	
118	(116, 120)	10.0	10.0	10.0
120		10.0	10.0	
124		10.0	10.0	
126	(124, 128)	10.0	10.0	10.0
128		10.0	10.0	
132		10.0	10.0	
134	(132, 136)	10.0	10.0	10.0
136		10.0	10.0	
140		10.0	10.0	
149				
151	(149, 153)			

<b>20 MHZ CHANNEL</b>	<b>40 MHZ CHANNEL</b>	<b>LEGACY OFDM RATES (6,9,12,18,24,36,48,54 MBPS)</b>	<b>802.11n HT20 RATES (MCS 0 MCS 15)</b>	<b>802.11n HT40 RATES (MCS 0 MCS 15)</b>
153				
157				
159	(157, 161)			
161				
165				

External panel antenna, peak gain = 14dBi

### 17.6.3 External Yagi Antenna Model

The following is a transmit power table (Japan domain) per external yagi antenna in the 5 GHz band:

<b>20 MHZ CHANNEL</b>	<b>40 MHZ CHANNEL</b>	<b>LEGACY OFDM RATES (6,9,12,18,24,36,48,54 MBPS)</b>	<b>802.11n HT20 RATES (MCS 0 MCS 15)</b>	<b>802.11n HT40 RATES (MCS 0 MCS 15)</b>
36		7.0	7.0	
38	(36, 40)	7.0	7.0	7.0
40		7.0	7.0	
44		7.0	7.0	
46	(44, 48)	7.0	7.0	7.0
48		7.0	7.0	
52		7.0	7.0	
54	(52, 56)	7.0	7.0	7.0
56		7.0	7.0	
60		7.0	7.0	
62	(60, 64)	7.0	7.0	7.0
64		7.0	7.0	
100		14.0	14.0	
102	(100, 104)	14.0	14.0	14.0
104		14.0	14.0	
108		14.0	14.0	
110		14.0	14.0	14.0
112	(108, 112)	14.0	14.0	
116		14.0	14.0	
118	(116, 120)	14.0	14.0	14.0
120		14.0	14.0	
124		14.0	14.0	
126	(124, 128)	14.0	14.0	14.0
128		14.0	14.0	
132		14.0	14.0	
134	(132, 136)	14.0	14.0	14.0
136		14.0	14.0	
140		14.0	14.0	
149				
151	(149, 153)			

<b>20 MHZ CHANNEL</b>	<b>40 MHZ CHANNEL</b>	<b>LEGACY OFDM RATES (6,9,12,18,24,36,48,54 MBPS)</b>	<b>802.11n HT20 RATES (MCS 0 MCS 15)</b>	<b>802.11n HT40 RATES (MCS 0 MCS 15)</b>
153				
157				
159	(157, 161)			
161				
165				

External yagi antenna, peak gain = 10.5dBi

### 17.6.4 External Patch Antenna Model

The following is a transmit power table (Japan domain) per external patch antenna in the 5 GHz band:

<b>20 MHZ CHANNEL</b>	<b>40 MHZ CHANNEL</b>	<b>LEGACY OFDM RATES (6,9,12,18,24,36,48,54 MBPS)</b>	<b>802.11n HT20 RATES (MCS 0 MCS 15)</b>	<b>802.11n HT40 RATES (MCS 0 MCS 15)</b>
36		13.5	13.5	
38	(36, 40)	13.5	13.5	13.5
40		13.5	13.5	
44		13.5	13.5	
46	(44, 48)	13.5	13.5	13.5
48		13.5	13.5	
52		13.5	13.5	
54	(52, 56)	13.5	13.5	13.5
56		13.5	13.5	
60		13.5	13.5	
62	(60, 64)	13.5	13.5	13.5
64		13.5	13.5	
100		20.0	20.0	
102	(100, 104)	20.0	20.0	20.0
104		20.0	20.0	
108		20.0	20.0	
110		20.0	20.0	20.0
112	(108, 112)	20.0	20.0	
116		20.0	20.0	
118	(116, 120)	20.0	20.0	20.0
120		20.0	20.0	
124		20.0	20.0	
126	(124, 128)	20.0	20.0	20.0
128		20.0	20.0	
132		20.0	20.0	
134	(132, 136)	20.0	20.0	20.0
136		20.0	20.0	
140		20.0	20.0	
149				
151	(149, 153)			

<b>20 MHZ CHANNEL</b>	<b>40 MHZ CHANNEL</b>	<b>LEGACY OFDM RATES (6,9,12,18,24,36,48,54 MBPS)</b>	<b>802.11n HT20 RATES (MCS 0 MCS 15)</b>	<b>802.11n HT40 RATES (MCS 0 MCS 15)</b>
153				
157				
159	(157, 161)			
161				
165				

External patch antenna, peak gain = 3.8dBi



### 17.6.5 Facade Antenna Model

The following is a transmit power table (Japan domain) per external facade antenna in the 5 GHz band:

<b>20 MHZ CHANNEL</b>	<b>40 MHZ CHANNEL</b>	<b>LEGACY OFDM RATES (6,9,12,18,24,36,48,54 MBPS)</b>	<b>802.11n HT20 RATES (MCS 0 MCS 15)</b>	<b>802.11n HT40 RATES (MCS 0 MCS 15)</b>
36		13.5	13.5	
38	(36, 40)	13.5	13.5	13.5
40		13.5	13.5	
44		13.5	13.5	
46	(44, 48)	13.5	13.5	13.5
48		13.5	13.5	
52		13.5	13.5	
54	(52, 56)	13.5	13.5	13.5
56		13.5	13.5	
60		13.5	13.5	
62	(60, 64)	13.5	13.5	13.5
64		13.5	13.5	
100		20.0	20.0	
102	(100, 104)	20.0	20.0	20.0
104		20.0	20.0	
108		20.0	20.0	
110		20.0	20.0	20.0
112	(108, 112)	20.0	20.0	
116		20.0	20.0	
118	(116, 120)	20.0	20.0	20.0
120		20.0	20.0	
124		20.0	20.0	
126	(124, 128)	20.0	20.0	20.0
128		20.0	20.0	
132		20.0	20.0	
134	(132, 136)	20.0	20.0	20.0
136		20.0	20.0	
140		20.0	20.0	
149				
151	(149, 153)			

<b>20 MHZ CHANNEL</b>	<b>40 MHZ CHANNEL</b>	<b>LEGACY OFDM RATES (6,9,12,18,24,36,48,54 MBPS)</b>	<b>802.11n HT20 RATES (MCS 0 MCS 15)</b>	<b>802.11n HT40 RATES (MCS 0 MCS 15)</b>
153				
157				
159	(157, 161)			
161				
165				

Facade antenna, peak gain = 4dBi

# 18

## ***AP8122 Regulatory Domains***

### **18.1 US Regulatory Domain 2.4 GHz Band**

#### ***18.1.1 Internal Antenna Maximum Conducted Transmit Power Settings***

The following is a transmit power table (US domain) per internal antenna in the 2.4 GHz band:

<b>20 MHZ CHANNEL</b>	<b>40 MHZ CHANNEL</b>	<b>LEGACY DSSS RATES (1, 2, 5.5, 11 MBPS)</b>	<b>LEGACY OFDM RATES (6,9,12,18,24,36, 48,54 MBPS)</b>	<b>802.11n HT20 RATES (MCS 0 MCS 15)</b>	<b>802.11n HT40 RATES (MCS 0 MCS15)</b>
1		20.0	21.0	16.0	
2		22.0	23.0	18.0	
3	(1, 5)	22.0	23.0	18.0	11.0
4	(2, 6)	22.0	23.0	18.0	11.0
5	(3, 7)	22.0	23.0	18.0	15.0
6	(4, 8)	22.0	23.0	18.0	15.0
7	(5, 9)	22.0	23.0	18.0	15.0
8	(6, 10)	22.0	23.0	18.0	11.0
9	(7, 11)	22.0	23.0	18.0	11.0
10		22.0	23.0	18.0	
11		20.0	20.0	15.0	

Internal antenna, peak gain = 4.4dBi

## 18.2 US Regulatory Domain 5 GHz Band

### 18.2.1 Internal Antenna Model

The following is a transmit power table (US domain) per internal antenna in the 5 GHz band:

<b>20 MHZ CHANNEL</b>	<b>40 MHZ CHANNEL</b>	<b>LEGACY OFDM RATES (6,9,12,18,24,36,48,54 MBPS)</b>	<b>802.11n HT20 RATES (MCS 0 MCS 15)</b>	<b>802.11n HT40 RATES (MCS 0 MCS 15)</b>
36		17.0	11.5	
38	(36, 40)	17.0	11.5	5.5
40		17.0	11.5	
44		17.0	11.5	
46	(44, 48)	17.0	11.5	9.0
48		17.0	11.5	
52		20.0	20.0	
54	(52, 56)	20.0	20.0	16.0
56		20.0	20.0	
60		20.0	20.0	
62	(60, 64)	20.0	20.0	8.5
64		20.0	20.0	
100		17.0	12.5	
102	(100, 104)	17.0	12.5	7.0
104		20.0	20.0	
108		20.0	20.0	
110		20.0	20.0	18.0
112		20.0	20.0	
116		18.0	13.5	
118	(116, 120)	20.0	20.0	18.0
120		20.0	20.0	
124		20.0	20.0	
126	(124, 128)	20.0	20.0	18.0
128		20.0	20.0	
132		20.0	20.0	
134	(132, 136)	20.0	20.0	9.0
136		20.0	20.0	
140		20.0	20.0	
142		17.0	12.0	9.0

<b>20 MHZ CHANNEL</b>	<b>40 MHZ CHANNEL</b>	<b>LEGACY OFDM RATES (6,9,12,18,24,36,48,54 MBPS)</b>	<b>802.11n HT20 RATES (MCS 0 MCS 15)</b>	<b>802.11n HT40 RATES (MCS 0 MCS 15)</b>
144		17.0	12.0	
149		20.0	20.0	
151	(149, 153)	20.0	20.0	20.0
153		20.0	20.0	
155		20.0	20.0	
157		20.0	17.0	
159	(157, 161)	20.0	17.0	17.0
161		20.0	17.0	
165		20.0	15.5	

Internal antenna, peak gain = 4.7dBi

## 18.3 EU Regulatory Domain 2.4 GHz Band

### 18.3.1 Internal Antenna Model

The following is a transmit power table (EU domain) per internal antenna in the 2.4 GHz band:

<b>20 MHZ CHANNEL</b>	<b>40 MHZ CHANNEL</b>	<b>LEGACY DSSS RATES (1, 2, 5.5, 11 MBPS)</b>	<b>LEGACY OFDM RATES (6,9,12,18,24,36, 48,54 MBPS)</b>	<b>802.11n HT20 RATES (MCS 0 MCS 15)</b>	<b>802.11n HT40 RATES (MCS 0 MCS15)</b>
1		10.0	10.0	10.0	
2		10.0	10.0	10.0	
3	(1, 5)	10.0	10.0	10.0	10.0
4	(2, 6)	10.0	10.0	10.0	10.0
5	(3, 7)	10.0	10.0	10.0	10.0
6	(4, 8)	10.0	10.0	10.0	10.0
7	(5, 9)	10.0	10.0	10.0	10.0
8	(6, 10)	10.0	10.0	10.0	10.0
9	(7, 11)	10.0	10.0	10.0	10.0
10	(8, 12)	10.0	10.0	10.0	10.0
11	(9, 13)	10.0	10.0	10.0	10.0
12		10.0	10.0	10.0	
13		10.0	10.0	10.0	
14					

Internal antenna, peak gain = 4.4dBi

## 18.4 EU Regulatory Domain 5 GHz Band

### 18.4.1 Internal Antenna Model

The following is a transmit power table (EU domain) per internal antenna in the 5 GHz band:

<b>20 MHZ CHANNEL</b>	<b>40 MHZ CHANNEL</b>	<b>LEGACY OFDM RATES (6,9,12,18,24,36,48,54 MBPS)</b>	<b>802.11n HT20 RATES (MCS 0 MCS 15)</b>	<b>802.11n HT40 RATES (MCS 0 MCS 15)</b>
36		13.0	13.0	
38	(36, 40)	13.0	13.0	13.0
40		13.0	13.0	
44		13.0	13.0	
46	(44, 48)	13.0	13.0	13.0
48		13.0	13.0	
52		13.0	13.0	
54	(52, 56)	13.0	13.0	13.0
56		13.0	13.0	
60		13.0	13.0	
62	(60, 64)	13.0	13.0	13.0
64		13.0	13.0	
100		20.0	20.0	
102	(100, 104)	20.0	20.0	20.0
104		20.0	20.0	
108		20.0	20.0	
110	(108, 112)	20.0	20.0	20.0
112		20.0	20.0	
116		20.0	20.0	
118	(116, 120)	20.0	20.0	20.0
120		20.0	20.0	
122		20.0	20.0	
124		20.0	20.0	
126	(124, 128)	20.0	20.0	20.0
128		20.0	20.0	
132		20.0	20.0	
134	(132, 136)	20.0	20.0	20.0
136		20.0	20.0	
138		20.0	20.0	
140		20.0	20.0	

<b>20 MHZ CHANNEL</b>	<b>40 MHZ CHANNEL</b>	<b>LEGACY OFDM RATES (6,9,12,18,24,36,48,54 MBPS)</b>	<b>802.11n HT20 RATES (MCS 0 MCS 15)</b>	<b>802.11n HT40 RATES (MCS 0 MCS 15)</b>
142		20.0	20.0	
144		20.0	20.0	
149				
151	(149, 153)			
153				
157				
159	(157, 161)			
161				
165				

Internal antenna, peak gain = 4.7dBi



# 19

## **AP8163 Regulatory Domains**

### **19.1 US Regulatory Domain 2.4 GHz Band**

#### **19.1.1 External Dipole Antenna Maximum Conducted Transmit Power Settings**

The following is an AP8163 transmit power table (US domain) per external dipole antenna in the 2.4 GHz band:

<b>20 MHZ CHANNEL</b>	<b>40 MHZ CHANNEL</b>	<b>LEGACY DSSS RATES (1, 2, 5.5, 11 MBPS)</b>	<b>LEGACY OFDM RATES (6,9,12,18,24,36, 48,54 MBPS)</b>	<b>802.11n HT20 RATES (MCS 0 MCS 15)</b>	<b>802.11n HT40 RATES (MCS 0 MCS15)</b>
1		17.0	17.0	16.0	
2		17.0	17.0	17.0	
3	(1, 5)	18.0	21.0	21.0	13.0
4	(2, 6)	18.0	21.0	21.0	13.0
5	(3, 7)	18.0	21.0	21.0	19.0
6	(4, 8)	18.0	21.0	21.0	19.0
7	(5, 9)	18.0	21.0	21.0	19.0
8	(6, 10)	18.0	21.0	21.0	10.0
9	(7, 11)	18.0	21.0	21.0	10.0
10		18.0	17.0	17.0	
11		18.0	17.0	17.0	

External dipole antenna, peak gain = 10.5dBi

### 19.1.2 External Panel Antenna Maximum Conducted Transmit Power Settings

The following is an AP8163 transmit power table (US domain) per external panel antenna in the 2.4 GHz band:

<b>20 MHZ CHANNEL</b>	<b>40 MHZ CHANNEL</b>	<b>LEGACY DSSS RATES (1, 2, 5.5, 11 MBPS)</b>	<b>LEGACY OFDM RATES (6,9,12,18,24,36, 48,54 MBPS)</b>	<b>802.11n HT20 RATES (MCS 0 MCS 15)</b>	<b>802.11n HT40 RATES (MCS 0 MCS15)</b>
1		12.0	13.0	13.0	
2		17.0	17.0	17.0	
3	(1, 5)	17.0	17.0	17.0	10.0
4	(2, 6)	17.0	17.0	17.0	10.0
5	(3, 7)	17.0	17.0	17.0	14.0
6	(4, 8)	17.0	17.0	17.0	14.0
7	(5, 9)	17.0	17.0	17.0	14.0
8	(6, 10)	17.0	17.0	17.0	6.0
9	(7, 11)	17.0	17.0	17.0	6.0
10		17.0	17.0	17.0	
11		16.0	15.0	15.0	

External panel antenna, peak gain = 15dBi

### 19.1.3 External AP8163-USB Radio Maximum Conducted Transmit Power Settings

The following is an AP8163 transmit power table (US domain) per USB 3rd radio (2TX mode) in the 2.4 GHz band:

<b>20 MHZ CHANNEL</b>	<b>40 MHZ CHANNEL</b>	<b>LEGACY DSSS RATES (1, 2, 5.5, 11 MBPS)</b>	<b>LEGACY OFDM RATES (6,9,12,18,24,36, 48,54 MBPS)</b>	<b>802.11n HT20 RATES (MCS 0 MCS 15)</b>	<b>802.11n HT40 RATES (MCS 0 MCS15)</b>
1		20.0	13.0	13.0	
2		20.0	13.0	13.0	
3	(1, 5)	20.0	16.0	16.0	15.0
4	(2, 6)	20.0	16.0	16.0	15.0
5	(3, 7)	20.0	16.0	16.0	14.0
6	(4, 8)	20.0	16.0	16.0	14.0
7	(5, 9)	20.0	16.0	16.0	14.0
8	(6, 10)	20.0	16.0	16.0	14.0
9	(7, 11)	20.0	16.0	16.0	14.0
10		20.0	18.0	18.0	
11		20.0	18.0	18.0	

External AP8163-USB radio , peak gain = 5dBi

### 19.1.4 Dual-Polarized Antenna Maximum Conducted Transmit Power Settings

The following is an AP8163 transmit power table (US domain) per dual-polarized antenna in the 2.4 GHz band:

<b>20 MHZ CHANNEL</b>	<b>40 MHZ CHANNEL</b>	<b>LEGACY DSSS RATES (1, 2, 5.5, 11 MBPS)</b>	<b>LEGACY OFDM RATES (6,9,12,18,24,36, 48,54 MBPS)</b>	<b>802.11n HT20 RATES (MCS 0 MCS 15)</b>	<b>802.11n HT40 RATES (MCS 0 MCS15)</b>
1		15.0	13.0	13.0	
2		16.0	19.0	19.0	
3	(1, 5)	16.0	19.0	19.0	11.0
4	(2, 6)	16.0	19.0	19.0	15.0
5	(3, 7)	16.0	19.0	19.0	15.0
6	(4, 8)	16.0	19.0	19.0	15.0
7	(5, 9)	16.0	19.0	19.0	15.0
8	(6, 10)	16.0	19.0	19.0	15.0
9	(7, 11)	16.0	19.0	19.0	8.0
10		16.0	19.0	19.0	
11		15.0	14.0	14.0	

Dual-polarized antenna, peak gain = 9.5dBi

## 19.2 US Regulatory Domain 5 GHz Band

### 19.2.1 External Dipole Antenna Model

The following is an AP8163 transmit power table (US domain) per external dipole antenna in the 5 GHz band:

<b>20 MHZ CHANNEL</b>	<b>40 MHZ CHANNEL</b>	<b>LEGACY OFDM RATES (6,9,12,18,24,36,48,54 MBPS)</b>	<b>802.11n HT20 RATES (MCS 0 MCS 15)</b>	<b>802.11n HT40 RATES (MCS 0 MCS 15)</b>
36		8.0	8.0	
38	(36, 40)	8.0	8.0	8.0
40		8.0	8.0	
44		8.0	8.0	
46	(44, 48)	8.0	8.0	9.0
48		8.0	8.0	
52		15.0	16.0	
54	(52, 56)	15.0	15.0	16.0
56		15.0	15.0	
60		15.0	15.0	
62	(60, 64)	15.0	15.0	15.0
64		15.0	15.0	
100		15.0	15.0	
102	(100, 104)	15.0	15.0	11.5
104		15.0	15.0	
108		15.0	15.0	
110		15.0	15.0	15.0
112		15.0	15.0	
116		15.0	15.0	
118	(116, 120)	15.0	15.0	15.0
120		15.0	15.0	
124		15.0	15.0	
126	(124, 128)	15.0	15.0	16.0
128		15.0	15.0	
132		15.0	15.0	
134	(132, 136)	15.0	15.0	16.0
136		15.0	15.0	
140		14.0	14.0	
149		20.0	20.0	
151	(149, 153)	20.0	20.0	20.0

<b>20 MHZ CHANNEL</b>	<b>40 MHZ CHANNEL</b>	<b>LEGACY OFDM RATES (6,9,12,18,24,36,48,54 MBPS)</b>	<b>802.11n HT20 RATES (MCS 0 MCS 15)</b>	<b>802.11n HT40 RATES (MCS 0 MCS 15)</b>
153		20.0	20.0	
157		20.0	20.0	
159	(157, 161)	20.0	20.0	20.0
161		20.0	20.0	
165		20.0	20.0	

External dipole antenna, peak gain = 10.5dBi

## 19.2.2 External Panel Antenna Model

The following is an AP8163 transmit power table (US domain) per external panel antenna in the 5 GHz band:

<b>20 MHZ CHANNEL</b>	<b>40 MHZ CHANNEL</b>	<b>LEGACY OFDM RATES (6,9,12,18,24,36,48,54 MBPS)</b>	<b>802.11n HT20 RATES (MCS 0 MCS 15)</b>	<b>802.11n HT40 RATES (MCS 0 MCS 15)</b>
36		12.0	12.0	
38	(36, 40)	12.0	12.0	12.0
40		12.0	12.0	
44		12.0	12.0	
46	(44, 48)	12.0	12.0	12.0
48		12.0	12.0	
52		19.0	19.0	
54	(52, 56)	19.0	19.0	19.0
56		19.0	19.0	
60		19.0	19.0	
62	(60, 64)	19.0	19.0	19.0
64		19.0	19.0	
100		19.0	19.0	
102	(100, 104)	19.0	19.0	19.0
104		19.0	19.0	
108		19.0	19.0	
110		19.0	19.0	19.0
112		19.0	19.0	
116		19.0	19.0	
118	(116, 120)	19.0	19.0	19.0
120		19.0	19.0	
124		19.0	19.0	
126	(124, 128)	19.0	19.0	19.0
128		19.0	19.0	
132		19.0	19.0	
134	(132, 136)	19.0	19.0	19.0
136		19.0	19.0	
140		19.0	19.0	
149		20.0	20.0	
151	(149, 153)	20.0	20.0	20.0
153		20.0	20.0	

<b>20 MHZ CHANNEL</b>	<b>40 MHZ CHANNEL</b>	<b>LEGACY OFDM RATES (6,9,12,18,24,36,48,54 MBPS)</b>	<b>802.11n HT20 RATES (MCS 0 MCS 15)</b>	<b>802.11n HT40 RATES (MCS 0 MCS 15)</b>
157		20.0	20.0	
159	(157, 161)	20.0	20.0	20.0
161		20.0	20.0	
165		20.0	20.0	

External panel antenna, peak gain = 6Bi



### 19.2.3 External AP8163-USB Radio Maximum Conducted Transmit Power Settings

The following is an AP8163 transmit power table (US domain) per USB 3rd radio (2TX mode) in the 5 GHz band:

<b>20 MHZ CHANNEL</b>	<b>40 MHZ CHANNEL</b>	<b>LEGACY OFDM RATES (6,9,12,18,24,36,48,54 MBPS)</b>	<b>802.11n HT20 RATES (MCS 0 MCS 15)</b>	<b>802.11n HT40 RATES (MCS 0 MCS 15)</b>
36		11.0	11.0	
38	(36, 40)	11.0	11.0	11.0
40		11.0	11.0	
44		11.0	11.0	
46	(44, 48)	11.0	11.0	11.0
48		11.0	11.0	
52		18.0	18.0	
54	(52, 56)	18.0	18.0	18.0
56		18.0	18.0	
60		18.0	18.0	
62	(60, 64)	18.0	18.0	18.0
64		18.0	18.0	
100		12.0	12.0	
102	(100, 104)	12.0	12.0	12.0
104		19.0	19.0	
108		19.0	19.0	
110		19.0	19.0	19.0
112		19.0	19.0	
116		19.0	19.0	
118	(116, 120)	19.0	19.0	19.0
120		19.0	19.0	
124		19.0	19.0	
126	(124, 128)	19.0	19.0	19.0
128		19.0	19.0	
132		19.0	19.0	
134	(132, 136)	19.0	19.0	19.0
136		19.0	19.0	
140		12.0	12.0	
142	(142, 144)	12.0	12.0	12.0
144		12.0	12.0	
149		20.0	20.0	

<b>20 MHZ CHANNEL</b>	<b>40 MHZ CHANNEL</b>	<b>LEGACY OFDM RATES (6,9,12,18,24,36,48,54 MBPS)</b>	<b>802.11n HT20 RATES (MCS 0 MCS 15)</b>	<b>802.11n HT40 RATES (MCS 0 MCS 15)</b>
151	(149, 153)	20.0	20.0	20.0
153		20.0	20.0	
157		20.0	20.0	
159	(157, 161)	20.0	20.0	20.0
161		20.0	20.0	
165		20.0	20.0	

External AP8163-USB radio, peak gain = 8dBi

## 19.2.4 External Dual-Polarized Antenna Maximum Conducted Transmit Power Settings

The following is an AP8163 transmit power table (US domain) per external dual-polarized antenna in the 5 GHz band:

<b>20 MHZ CHANNEL</b>	<b>40 MHZ CHANNEL</b>	<b>LEGACY OFDM RATES (6,9,12,18,24,36,48,54 MBPS)</b>	<b>802.11n HT20 RATES (MCS 0 MCS 15)</b>	<b>802.11n HT40 RATES (MCS 0 MCS 15)</b>
36		11.0	11.0	
38	(36, 40)	11.0	11.0	7.0
40		11.0	11.0	
44		11.0	11.0	
46	(44, 48)	11.0	11.0	11.0
48		11.0	11.0	
52		16.0	16.0	
54	(52, 56)	16.0	16.0	11.0
56		16.0	16.0	
60		16.0	16.0	
62	(60, 64)	16.0	16.0	7.0
64		12.0	12.0	
100		13.0	13.0	
102	(100, 104)	17.0	17.0	5.0
104		17.0	17.0	
108		17.0	17.0	
110		17.0	17.0	13.0
112		17.0	17.0	
116		17.0	17.0	
118	(116, 120)	17.0	17.0	13.0
120		17.0	17.0	
124		17.0	17.0	
126	(124, 128)	17.0	17.0	13.0
128		17.0	17.0	
132		17.0	17.0	
134	(132, 136)	17.0	17.0	12.0
136		17.0	17.0	
140		11.0	11.0	
142	(142, 144)	20.0	20.0	12.0

<b>20 MHZ CHANNEL</b>	<b>40 MHZ CHANNEL</b>	<b>LEGACY OFDM RATES (6,9,12,18,24,36,48,54 MBPS)</b>	<b>802.11n HT20 RATES (MCS 0 MCS 15)</b>	<b>802.11n HT40 RATES (MCS 0 MCS 15)</b>
144		20.0	20.0	
149		20.0	20.0	
151	(149, 153)	20.0	20.0	20.0
153		20.0	20.0	
157		20.0	20.0	
159	(157, 161)	20.0	20.0	20.0
161		20.0	20.0	
165		20.0	20.0	

External dual-polarized antenna peak gain = 9.2dBi

## 19.3 EU Regulatory Domain 2.4 GHz Band

### 19.3.1 External Dipole Antenna Model

The following is an AP8163 transmit power table (EU domain) per external dipole antenna in the 2.4 GHz band:

<b>20 MHZ CHANNEL</b>	<b>40 MHZ CHANNEL</b>	<b>LEGACY DSSS RATES (1, 2, 5.5, 11 MBPS)</b>	<b>LEGACY OFDM RATES (6,9,12,18,24,36, 48,54 MBPS)</b>	<b>802.11n HT20 RATES (MCS 0 MCS 15)</b>	<b>802.11n HT40 RATES (MCS 0 MCS15)</b>
1		4.5	4.5	4.5	
2		4.5	4.5	4.5	
3	(1, 5)	4.5	4.5	4.5	4.5
4	(2, 6)	4.5	4.5	4.5	4.5
5	(3, 7)	4.5	4.5	4.5	4.5
6	(4, 8)	4.5	4.5	4.5	4.5
7	(5, 9)	4.5	4.5	4.5	4.5
8	(6, 10)	4.5	4.5	4.5	4.5
9	(7, 11)	4.5	4.5	4.5	4.5
10	(8, 12)	4.5	4.5	4.5	
11	(9, 13)	4.5	4.5	4.5	
12					
13					
14					

External dipole antenna, peak gain = 10.5dBi

### 19.3.2 External Panel Antenna Model

The following is an AP8163 transmit power table (EU domain) per external panel antenna in the 2.4 GHz band:

<b>20 MHZ CHANNEL</b>	<b>40 MHZ CHANNEL</b>	<b>LEGACY DSSS RATES (1, 2, 5.5, 11 MBPS)</b>	<b>LEGACY OFDM RATES (6,9,12,18,24,36, 48,54 MBPS)</b>	<b>802.11n HT20 RATES (MCS 0 MCS 15)</b>	<b>802.11n HT40 RATES (MCS 0 MCS15)</b>
1		6.0	6.0	7.0	
2		6.0	6.0	6.0	
3	(1, 5)	6.0	6.0	6.0	6.0
4	(2, 6)	6.0	6.0	6.0	6.0
5	(3, 7)	6.0	6.0	6.0	6.0
6	(4, 8)	6.0	6.0	6.0	6.0
7	(5, 9)	6.0	6.0	6.0	6.0
8	(6, 10)	6.0	6.0	6.0	6.0
9	(7, 11)	6.0	6.0	6.0	6.0
10	(8, 12)	6.0	6.0	6.0	6.0
11	(9, 13)	6.0	6.0	6.0	6.0
12					
13					
14					

External panel antenna, peak gain = 9dBi

### 19.3.3 External AP8163-USB Radio Maximum Conducted Transmit Power Settings

The following is an AP8163 transmit power table (EU domain) per USB 3rd radio (2TX mode) in the 2.4 GHz band:

<b>20 MHZ CHANNEL</b>	<b>40 MHZ CHANNEL</b>	<b>LEGACY DSSS RATES (1, 2, 5.5, 11 MBPS)</b>	<b>LEGACY OFDM RATES (6,9,12,18,24,36, 48,54 MBPS)</b>	<b>802.11n HT20 RATES (MCS 0 MCS 15)</b>	<b>802.11n HT40 RATES (MCS 0 MCS15)</b>
1		12.0	12.0	12.0	
2		12.0	12.0	12.0	
3	(1, 5)	12.0	12.0	12.0	15.0
4	(2, 6)	12.0	12.0	12.0	12.0
5	(3, 7)	12.0	12.0	12.0	12.0
6	(4, 8)	12.0	12.0	12.0	12.0
7	(5, 9)	12.0	12.0	12.0	12.0
8	(6, 10)	12.0	12.0	12.0	12.0
9	(7, 11)	12.0	12.0	12.0	12.0
10	(9, 12)	12.0	12.0	12.0	12.0
11	(10, 13)	12.0	12.0	12.0	12.0
12					
13					
14					

External AP8163-USB radio, peak gain = 5dBi

### 19.3.4 Dual-Polarization Antenna Model

The following is an AP8163 transmit power table (EU domain) per dual-polarization antenna in the 2.4 GHz band:

<b>20 MHZ CHANNEL</b>	<b>40 MHZ CHANNEL</b>	<b>LEGACY DSSS RATES (1, 2, 5.5, 11 MBPS)</b>	<b>LEGACY OFDM RATES (6,9,12,18,24,36, 48,54 MBPS)</b>	<b>802.11n HT20 RATES (MCS 0 MCS 15)</b>	<b>802.11n HT40 RATES (MCS 0 MCS15)</b>
1		5.5	5.5	7.0	
2		5.5	5.5	5.5	
3	(1, 5)	5.5	5.5	5.5	5.5
4	(2, 6)	5.5	5.5	5.5	5.5
5	(3, 7)	5.5	5.5	5.5	5.5
6	(4, 8)	5.5	5.5	5.5	5.5
7	(5, 9)	5.5	5.5	5.5	5.5
8	(6, 10)	5.5	5.5	5.5	5.5
9	(7, 11)	5.5	5.5	5.5	5.5
10	(8, 12)	5.5	5.5	5.5	5.5
11	(9, 13)	5.5	5.5	5.5	5.5
12					
13					
14					

Dual-polarization antenna, peak gain = 9.5dBi



## 19.4 EU Regulatory Domain 5 GHz Band

### 19.4.1 External Dipole Antenna Model

The following is an AP8163 transmit power table (EU domain) per external dipole antenna in the 5 GHz band:

<b>20 MHZ CHANNEL</b>	<b>40 MHZ CHANNEL</b>	<b>LEGACY OFDM RATES (6,9,12,18,24,36,48,54 MBPS)</b>	<b>802.11n HT20 RATES (MCS 0 MCS 15)</b>	<b>802.11n HT40 RATES (MCS 0 MCS 15)</b>
36		7.5	7.5	
38	(36, 40)	7.5	7.5	7.5
40		7.5	7.5	
44		7.5	7.5	
46	(44, 48)	7.5	7.5	7.5
48		7.5	7.5	
52		7.5	7.5	
54	(52, 56)	7.5	7.5	7.5
56		7.5	7.5	
60		7.5	7.5	
62	(60, 64)	7.5	7.5	7.5
64		7.5	7.5	
100		14.5	14.5	
102	(100, 104)	14.5	14.5	14.5
104		14.5	14.5	
108		14.5	14.5	
110		14.5	14.5	14.5
112	(108, 112)	14.5	14.5	
116		14.5	14.5	
118	(116, 120)	14.5	14.5	14.5
120		14.5	14.5	
124		14.5	14.5	
126	(124, 128)	14.5	14.5	14.5
128		14.5	14.5	
132		14.5	14.5	
134	(132, 136)	14.5	14.5	14.5
136		14.5	14.5	
140		14.5	14.5	
149				

<b>20 MHZ CHANNEL</b>	<b>40 MHZ CHANNEL</b>	<b>LEGACY OFDM RATES (6,9,12,18,24,36,48,54 MBPS)</b>	<b>802.11n HT20 RATES (MCS 0 MCS 15)</b>	<b>802.11n HT40 RATES (MCS 0 MCS 15)</b>
151	(149, 153)			
153				
157				
159	(157, 161)			
161				
165				

External dipole antenna, peak gain = 10.5dBi

## 19.4.2 External Panel Antenna Model

The following is an AP8163 transmit power table (EU domain) per external panel antenna in the 5 GHz band:

<b>20 MHZ CHANNEL</b>	<b>40 MHZ CHANNEL</b>	<b>LEGACY OFDM RATES (6,9,12,18,24,36,48,54 MBPS)</b>	<b>802.11n HT20 RATES (MCS 0 MCS 15)</b>	<b>802.11n HT40 RATES (MCS 0 MCS 15)</b>
36		4.0	4.0	
38	(36, 40)	4.0	4.0	4.0
40		4.0	4.0	
44		4.0	4.0	
46	(44, 48)	4.0	4.0	4.0
48		4.0	4.0	
52		4.0	4.0	
54	(52, 56)	4.0	4.0	4.0
56		4.0	4.0	
60		4.0	4.0	
62	(60, 64)	4.0	4.0	4.0
64		4.0	4.0	
100		11.0	11.0	
102	(100, 104)	11.0	11.0	11.0
104		11.0	11.0	
108		11.0	11.0	
110		11.0	11.0	11.0
112	(108, 112)	11.0	11.0	
116		11.0	11.0	
118	(116, 120)	11.0	11.0	11.0
120		11.0	11.0	
124		11.0	11.0	
126	(124, 128)	11.0	11.0	11.0
128		11.0	11.0	
132		11.0	11.0	
134	(132, 136)	11.0	11.0	11.0
136		11.0	11.0	
140		11.0	11.0	
149				
151	(149, 153)			

<b>20 MHZ CHANNEL</b>	<b>40 MHZ CHANNEL</b>	<b>LEGACY OFDM RATES (6,9,12,18,24,36,48,54 MBPS)</b>	<b>802.11n HT20 RATES (MCS 0 MCS 15)</b>	<b>802.11n HT40 RATES (MCS 0 MCS 15)</b>
153				
157				
159	(157, 161)			
161				
165				

External panel antenna, peak gain = 14dBi

### 19.4.3 External AP8163-USB Radio Maximum Conducted Transmit Power Settings

The following is an AP8163 transmit power table (EU domain) per USB 3rd radio (2TX mode) in the 5 GHz band:

<b>20 MHZ CHANNEL</b>	<b>40 MHZ CHANNEL</b>	<b>LEGACY OFDM RATES (6,9,12,18,24,36,48,54 MBPS)</b>	<b>802.11n HT20 RATES (MCS 0 MCS 15)</b>	<b>802.11n HT40 RATES (MCS 0 MCS 15)</b>
36		11.0	11.0	
38	(36, 40)	11.0	11.0	11.0
40		11.0	11.0	
44		11.0	11.0	
46	(44, 48)	11.0	11.0	11.0
48		11.0	11.0	
52		18.0	18.0	
54	(52, 56)	18.0	18.0	18.0
56		18.0	18.0	
60		18.0	18.0	
62	(60, 64)	18.0	18.0	18.0
64		18.0	18.0	
100		12.0	12.0	
102	(100, 104)	12.0	12.0	12.0
104		19.0	19.0	
108		19.0	19.0	
110		19.0	19.0	19.0
112		19.0	19.0	
116		19.0	19.0	
118	(116, 120)	19.0	19.0	19.0
120		19.0	19.0	
124		19.0	19.0	
126	(124, 128)	19.0	19.0	19.0
128		19.0	19.0	
132		19.0	19.0	
134	(132, 136)	19.0	19.0	19.0
136		19.0	19.0	
140		12.0	12.0	
142	(142, 144)			
144				

<b>20 MHZ CHANNEL</b>	<b>40 MHZ CHANNEL</b>	<b>LEGACY OFDM RATES (6,9,12,18,24,36,48,54 MBPS)</b>	<b>802.11n HT20 RATES (MCS 0 MCS 15)</b>	<b>802.11n HT40 RATES (MCS 0 MCS 15)</b>
149				
151	(149, 153)			
153				
157				
159	(157, 161)			
161				
165				

External AP8163-USB radio, peak gain = 8dBi

### 19.4.4 Dual-Polarization Antenna Maximum Conducted Transmit Power Settings

The following is an AP8163 transmit power table (EU domain) per dual-polarization antenna in the 5 GHz band:

<b>20 MHZ CHANNEL</b>	<b>40 MHZ CHANNEL</b>	<b>LEGACY OFDM RATES (6,9,12,18,24,36,48,54 MBPS)</b>	<b>802.11n HT20 RATES (MCS 0 MCS 15)</b>	<b>802.11n HT40 RATES (MCS 0 MCS 15)</b>
36		9.0	9.0	
38	(36, 40)	9.0	9.0	9.0
40		9.0	9.0	
44		9.0	9.0	
46	(44, 48)	9.0	9.0	9.0
48		9.0	9.0	
52		9.0	9.0	
54	(52, 56)	9.0	9.0	9.0
56		9.0	9.0	
60		9.0	9.0	
62	(60, 64)	9.0	9.0	9.0
64		9.0	9.0	
100		12.0	12.0	
102	(100, 104)	12.0	12.0	12.0
104		12.0	12.0	
108		12.0	12.0	
110		12.0	12.0	12.0
112		12.0	12.0	
116		12.0	12.0	
118	(116, 120)	12.0	12.0	12.0
120		12.0	12.0	
124		12.0	12.0	
126	(124, 128)	12.0	12.0	12.0
128		12.0	12.0	
132		12.0	12.0	
134	(132, 136)	12.0	12.0	12.0
136		12.0	12.0	
140		12.0	12.0	
142	(142, 144)			
144				

<b>20 MHZ CHANNEL</b>	<b>40 MHZ CHANNEL</b>	<b>LEGACY OFDM RATES (6,9,12,18,24,36,48,54 MBPS)</b>	<b>802.11n HT20 RATES (MCS 0 MCS 15)</b>	<b>802.11n HT40 RATES (MCS 0 MCS 15)</b>
149				
151	(149, 153)			
153				
157				
159	(157, 161)			
161				
165				

Dual-polarization antenna, peak gain = 9.2dBi



# 20

## ***AP8232 Regulatory Domains***

### **20.1 US Regulatory Domain 2.4 GHz Band**

#### ***20.1.1 External Dipole Antenna Maximum Conducted Transmit Power Settings***

The following is a transmit power table (US domain) per external dipole antenna in the 2.4 GHz band:

<b>20 MHZ CHANNEL</b>	<b>40 MHZ CHANNEL</b>	<b>LEGACY DSSS RATES (1, 2, 5.5, 11 MBPS)</b>	<b>LEGACY OFDM RATES (6,9,12,18,24,36, 48,54 MBPS)</b>	<b>802.11n HT20 RATES (MCS 0 MCS 15)</b>	<b>802.11n HT40 RATES (MCS 0 MCS15)</b>
1		17.0	17.0	16.0	
2		17.0	17.0	17.0	
3	(1, 5)	18.0	21.0	21.0	13.0
4	(2, 6)	18.0	21.0	21.0	13.0
5	(3, 7)	18.0	21.0	21.0	19.0
6	(4, 8)	18.0	21.0	21.0	19.0
7	(5, 9)	18.0	21.0	21.0	19.0
8	(6, 10)	18.0	21.0	21.0	10.0
9	(7, 11)	18.0	21.0	21.0	10.0
10		18.0	17.0	17.0	
11		18.0	17.0	17.0	

External dipole antenna, peak gain = 10.5dBi

## 20.1.2 External Panel Antenna Maximum Conducted Transmit Power Settings

The following is a transmit power table (US domain) per external panel antenna in the 2.4 GHz band:

<b>20 MHZ CHANNEL</b>	<b>40 MHZ CHANNEL</b>	<b>LEGACY DSSS RATES (1, 2, 5.5, 11 MBPS)</b>	<b>LEGACY OFDM RATES (6,9,12,18,24,36, 48,54 MBPS)</b>	<b>802.11n HT20 RATES (MCS 0 MCS 15)</b>	<b>802.11n HT40 RATES (MCS 0 MCS15)</b>
1		12.0	13.0	13.0	
2		17.0	17.0	17.0	
3	(1, 5)	17.0	17.0	17.0	10.0
4	(2, 6)	17.0	17.0	17.0	10.0
5	(3, 7)	17.0	17.0	17.0	14.0
6	(4, 8)	17.0	17.0	17.0	14.0
7	(5, 9)	17.0	17.0	17.0	14.0
8	(6, 10)	17.0	17.0	17.0	6.0
9	(7, 11)	17.0	17.0	17.0	6.0
10		17.0	17.0	17.0	
11		16.0	15.0	15.0	

External Panel antenna, peak gain = 15dBi

### 20.1.3 External Yagi Antenna Maximum Conducted Transmit Power Settings

The following is a transmit power table (US domain) per external yagi antenna in the 2.4 GHz band:

<b>20 MHZ CHANNEL</b>	<b>40 MHZ CHANNEL</b>	<b>LEGACY DSSS RATES (1, 2, 5.5, 11 MBPS)</b>	<b>LEGACY OFDM RATES (6,9,12,18,24,36, 48,54 MBPS)</b>	<b>802.11n HT20 RATES (MCS 0 MCS 15)</b>	<b>802.11n HT40 RATES (MCS 0 MCS15)</b>
1		8.0	9.0	9.0	
2		8.0	13.0	13.0	
3	(1, 5)	17.0	13.0	13.0	9.0
4	(2, 6)	17.0	13.0	13.0	9.0
5	(3, 7)	17.0	13.0	13.0	12.0
6	(4, 8)	17.0	13.0	13.0	12.0
7	(5, 9)	17.0	13.0	13.0	12.0
8	(6, 10)	17.0	13.0	13.0	6.0
9	(7, 11)	17.0	13.0	13.0	6.0
10		6.0	13.0	13.0	
11		6.0	13.0	13.0	

External yagi antenna, peak gain = 14.0dBi

### 20.1.4 External Patch Antenna Maximum Conducted Transmit Power Settings

The following is a transmit power table (US domain) per external patch antenna in the 2.4 GHz band:

<b>20 MHZ CHANNEL</b>	<b>40 MHZ CHANNEL</b>	<b>LEGACY DSSS RATES (1, 2, 5.5, 11 MBPS)</b>	<b>LEGACY OFDM RATES (6,9,12,18,24,36, 48,54 MBPS)</b>	<b>802.11n HT20 RATES (MCS 0 MCS 15)</b>	<b>802.11n HT40 RATES (MCS 0 MCS15)</b>
1		20.0	17.0	17.0	
2		23.0	23.0	23.0	
3	(1, 5)	23.0	23.0	23.0	13.0
4	(2, 6)	23.0	23.0	23.0	13.0
5	(3, 7)	23.0	23.0	23.0	18.0
6	(4, 8)	23.0	23.0	23.0	18.0
7	(5, 9)	23.0	23.0	23.0	18.0
8	(6, 10)	23.0	23.0	23.0	14.0
9	(7, 11)	23.0	23.0	23.0	14.0
10		23.0	23.0	23.0	
11		19.0	17.0	17.0	

External patch antenna, peak gain = 4dBi

### 20.1.5 Facade Antenna Maximum Conducted Transmit Power Settings

The following is a transmit power table (US domain) per internal facade antenna in the 2.4 GHz band:

<b>20 MHZ CHANNEL</b>	<b>40 MHZ CHANNEL</b>	<b>LEGACY DSSS RATES (1, 2, 5.5, 11 MBPS)</b>	<b>LEGACY OFDM RATES (6,9,12,18,24,36, 48,54 MBPS)</b>	<b>802.11n HT20 RATES (MCS 0 MCS 15)</b>	<b>802.11n HT40 RATES (MCS 0 MCS15)</b>
1		20.0	18.0	18.0	
2		23.0	23.0	23.0	
3	(1, 5)	23.0	23.0	23.0	14.0
4	(2, 6)	23.0	23.0	23.0	18.0
5	(3, 7)	23.0	23.0	23.0	18.0
6	(4, 8)	23.0	23.0	23.0	18.0
7	(5, 9)	23.0	23.0	23.0	18.0
8	(6, 10)	23.0	23.0	23.0	18.0
9	(7, 11)	23.0	23.0	23.0	14.0
10		23.0	23.0	23.0	
11		20.0	19.0	19.0	

Facade antenna, peak gain = 3.5dBi

## 20.2 US Regulatory Domain 5 GHz Band

### 20.2.1 External Dipole Antenna Model

The following is a transmit power table (US domain) per external dipole antenna in the 5 GHz band:

<b>20 MHZ CHANNEL</b>	<b>40 MHZ CHANNEL</b>	<b>80 MHZ CHANNELS</b>	<b>LEGACY OFDM RATES (6,9,12,18,24,36,48,54 MBPS)</b>	<b>802.11n HT20 RATES (MCS 0 MCS 15)</b>	<b>802.11n HT40 RATES (MCS 0 MCS 15)</b>	<b>802.11n HT80RATES (MCS 0 MCS 15)</b>
36			8.0	10.5		
38	(36, 40)		7.0	10.5	11.0	
40			7.0	10.5		
42		(36, 40, 44, 48)	7.0	10.5		10.5
44			7.0	10.5		
46	(44, 48)		7.0	10.5	11.0	
48			7.0	10.5		
52			13.0	13.0		
54	(52, 56)		13.0	13.0	15.0	
56			13.0	13.0		
58		(52, 56, 60, 64)	13.0	13.0		10.5
60			13.0	13.0		
62	(60, 64)		13.0	13.0	15.0	
64			13.0	13.0		
100			13.0	13.0		
102	(100, 104)		13.0	13.0	13.0	
104			13.0	13.0		
106		(100, 104, 108, 112)	13.0	13.0		7.5
108			13.0	13.0		
110			13.0	13.0	13.0	
112			13.0	13.0		
114			13.0	13.0		
116			13.0	13.0		
118	(116, 120)		13.0	13.0	13.0	
120			13.0	13.0		
122		(116, 120, 124, 128)	13.0	13.0		

<b>20 MHZ CHANNEL</b>	<b>40 MHZ CHANNEL</b>	<b>80 MHZ CHANNELS</b>	<b>LEGACY OFDM RATES (6,9,12,18,24,36, 48,54 MBPS)</b>	<b>802.11n HT20 RATES (MCS 0 MCS 15)</b>	<b>802.11n HT40 RATES (MCS 0 MCS 15)</b>	<b>802.11n HT80RATES (MCS 0 MCS 15)</b>
124			13.0	13.0		
126	(124, 128)		13.0	13.0		
128			13.0	13.0		
130			13.0	13.0		
132			13.0	13.0		
134	(132, 136)		13.0	13.0	13.0	
136			13.0	13.0		
138			13.0	13.0		
140			8.5	8.5		
142			8.5	8.5	8.5	
144			8.5	8.5		
149			20.0	20.0		
151	(149, 153)		20.0	20.0	20.0	
153			20.0	20.0		
155		(149, 153, 157, 161)	20.0	20.0		20.0
157			20.0	20.0		
159	(157, 161)		20.0	20.0	20.0	
161			20.0	20.0		
165			20.0	20.0		

External dipole antenna, peak gain = 10.5dBi

## 20.2.2 External Panel Antenna Model

The following is a transmit power table (US domain) per external panel antenna in the 5 GHz band:

<b>20 MHZ CHANNEL</b>	<b>40 MHZ CHANNEL</b>	<b>80 MHZ CHANNELS</b>	<b>LEGACY OFDM RATES (6,9,12,18,24,36,48,54 MBPS)</b>	<b>802.11n HT20 RATES (MCS 0 MCS 15)</b>	<b>802.11n HT40 RATES (MCS 0 MCS 15)</b>	<b>802.11n HT80RATES (MCS 0 MCS 15)</b>
36			6.0	6.0		
38	(36, 40)		6.0	6.0	10.0	
40			6.0	6.0		
42		(36, 40, 44, 48)	6.0	6.0		6.0
44			6.0	6.0		
46	(44, 48)		6.0	6.0	10.0	
48			6.0	6.0		
52			9.0	12.0		
54	(52, 56)		9.0	12.0	13.5	
56			9.0	12.0		
58		(52, 56, 60, 64)	9.0	12.0		6.0
60			9.0	12.0		
62	(60, 64)		5.0	8.0	11.5	
64			5.0	8.0		
100			5.0	8.0		
102	(100, 104)		9.0	12.0	11.5	
104			9.0	12.0		
106		(100, 104, 108, 112)	9.0	12.0		3.5
108			9.0	12.0		
110			9.0	12.0	11.5	
112			9.0	12.0		
114			9.0	12.0		
116			9.0	12.0		
118	(116, 120)		9.0	12.0	11.5	
120			9.0	12.0		
122		(116, 120, 124, 128)	9.0	12.0		
124			9.0	12.0		
126	(124, 128)		9.0	12.0	11.5	
128			9.0	12.0		



<b>20 MHZ CHANNEL</b>	<b>40 MHZ CHANNEL</b>	<b>80 MHZ CHANNELS</b>	<b>LEGACY OFDM RATES (6,9,12,18,24,36, 48,54 MBPS)</b>	<b>802.11n HT20 RATES (MCS 0 MCS 15)</b>	<b>802.11n HT40 RATES (MCS 0 MCS 15)</b>	<b>802.11n HT80RATES (MCS 0 MCS 15)</b>
130			9.0	12.0		
132			9.0	12.0		
134	(132, 136)		9.0	12.0	11.5	
136			9.0	12.0		
138			3.5	6.5		
140			3.5	6.5		
142			3.5	6.5	11.5	
144			3.5	6.5		
149			20.0	20.0		
151	(149, 153)		20.0	20.0	20.0	
153			20.0	20.0		
155		(149, 153, 157, 161)	20.0	20.0		20.0
157			20.0	20.0		
159	(157, 161)		20.0	20.0	20.0	
161			20.0	20.0		
165			20.0	20.0		

External panel antenna, peak gain = 12dBi

### 20.2.3 External Yagi Antenna Model

The following is a transmit power table (US domain) per external yagi antenna in the 5 GHz band:

<b>20 MHZ CHANNEL</b>	<b>40 MHZ CHANNEL</b>	<b>80 MHZ CHANNELS</b>	<b>LEGACY OFDM RATES (6,9,12,18,24,36,48,54 MBPS)</b>	<b>802.11n HT20 RATES (MCS 0 MCS 15)</b>	<b>802.11n HT40 RATES (MCS 0 MCS 15)</b>	<b>802.11n HT80RATES (MCS 0 MCS 15)</b>
36			7.5	10.5		
38	(36, 40)		7.5	10.5	11.5	
40			7.5	10.5		
42		(36, 40, 44, 48)	7.5	10.5		7.0
44			7.5	10.5		
46	(44, 48)		7.5	10.5	11.5	
48			7.5	10.5		
52			11.5	14.5		
54	(52, 56)		11.5	14.5	13.0	
56			8.5	11.5		
58		(52, 56, 60, 64)	11.5	14.5		4.0
60			11.5	14.5		
62	(60, 64)		6.0	9.0	10.0	
64			6.0	9.0		
100			10.0	13.0		
102	(100, 104)		10.0	13.0	14.0	
104			10.0	13.0		
106		(100, 104, 108, 112)	10.0	13.0		4.0
108			10.0	13.0		
110			10.0	13.0	14.0	
112			10.0	13.0		
114			10.0	13.0		
116			10.0	13.0		
118	(116, 120)		10.0	13.0	14.0	
120			10.0	13.0		
122		(116, 120, 124, 128)	10.0	13.0		
124			10.0	13.0		
126	(124, 128)		10.0	13.0	14.0	

<b>20 MHZ CHANNEL</b>	<b>40 MHZ CHANNEL</b>	<b>80 MHZ CHANNELS</b>	<b>LEGACY OFDM RATES (6,9,12,18,24,36, 48,54 MBPS)</b>	<b>802.11n HT20 RATES (MCS 0 MCS 15)</b>	<b>802.11n HT40 RATES (MCS 0 MCS 15)</b>	<b>802.11n HT80RATES (MCS 0 MCS 15)</b>
128			10.0	13.0		
130			10.0	13.0		
132			10.0	13.0		
134	(132, 136)		10.0	13.0	14.0	
136			10.0	13.0		
138			10.0	13.0		
140			6.5	9.5		
142			6.5	9.5	13.0	
144			6.5	9.5		
149			20.0	20.0		
151	(149, 153)		20.0	20.0	20.0	
153			20.0	20.0		
155		(149, 153, 157, 161)	20.0	20.0		20.0
157			20.0	20.0		
159	(157, 161)		20.0	20.0	20.0	
161			20.0	20.0		
165			20.0	20.0		

Panel antenna, peak gain = 10.5dBi

## 20.2.4 External Patch Antenna Model

The following is a transmit power table (US domain) per external patch antenna in the 5 GHz band:

<b>20 MHZ CHANNEL</b>	<b>40 MHZ CHANNEL</b>	<b>80 MHZ CHANNELS</b>	<b>LEGACY OFDM RATES (6,9,12,18,24,36,48,54 MBPS)</b>	<b>802.11n HT20 RATES (MCS 0 MCS 15)</b>	<b>802.11n HT40 RATES (MCS 0 MCS 15)</b>	<b>802.11n HT80RATES (MCS 0 MCS 15)</b>
36			10.0	13.0		
38	(36, 40)		10.0	13.0	13.5	
40			10.0	13.0		
42		(36, 40, 44, 48)	10.0	13.0		13.0
44			10.0	13.0		
46	(44, 48)		10.0	13.0	13.5	
48			10.0	13.0		
52			13.0	16.0		
54	(52, 56)		13.0	16.0	16.0	
56			13.0	16.0		
58		(52, 56, 60, 64)	13.0	16.0		13.5
60			13.0	16.0		
62	(60, 64)		13.0	16.0	14.0	
64			9.0	12.0		
100			11.5	12.0		
102	(100, 104)		11.5	12.0	15.0	
104			11.5	15.0		
106		(100, 104, 108, 112)	12.0	15.0		12.0
108			12.0	15.0		
110			12.0	15.0	16.0	
112			12.0	15.0		
114			12.0	15.0		
116			12.0	15.0		
118	(116, 120)		12.0	15.0	16.0	
120			12.0	15.0		
122		(116, 120, 124, 128)	12.0	15.0		
124			12.0	15.0		
126	(124, 128)		12.0	15.0	16.0	

<b>20 MHZ CHANNEL</b>	<b>40 MHZ CHANNEL</b>	<b>80 MHZ CHANNELS</b>	<b>LEGACY OFDM RATES (6,9,12,18,24,36,48,54 MBPS)</b>	<b>802.11n HT20 RATES (MCS 0 MCS 15)</b>	<b>802.11n HT40 RATES (MCS 0 MCS 15)</b>	<b>802.11n HT80RATES (MCS 0 MCS 15)</b>
128			12.0	15.0		
130			12.0	15.0		
132			12.0	15.0		
134	(132, 136)		12.0	15.0	16.0	
136			12.0	15.0		
138			12.0	15.0		
140			9.0	12.0		
142			9.0	12.0	12.0	
144			9.0	12.0		
149			20.0	20.0		
151	(149, 153)		20.0	20.0	20.0	
153			20.0	20.0		
155		(149, 153, 157, 161)	20.0	20.0		20.0
157			20.0	20.0		
159	(157, 161)		20.0	20.0	20.0	
161			20.0	20.0		
165			20.0	20.0		

External patch antenna, peak gain = 3.8dBi

## 20.2.5 Facade Antenna Model

The following is a transmit power table (US domain) per external facade antenna in the 5 GHz band:

<b>20 MHZ CHANNEL</b>	<b>40 MHZ CHANNEL</b>	<b>80 MHZ CHANNELS</b>	<b>LEGACY OFDM RATES (6,9,12,18,24,36,48,54 MBPS)</b>	<b>802.11n HT20 RATES (MCS 0 MCS 15)</b>	<b>802.11n HT40 RATES (MCS 0 MCS 15)</b>	<b>802.11n HT80RATES (MCS 0 MCS 15)</b>
36			10.0	13.0		
38	(36, 40)		10.0	13.0	13.0	
40			10.0	13.0		
42		(36, 40, 44, 48)	10.0	13.0		13.0
44			10.0	13.0		
46	(44, 48)		10.0	13.0	13.0	
48			10.0	13.0		
52			11.0	14.0		
54	(52, 56)		11.0	14.0	16.0	
56			11.0	14.0		
58		(52, 56, 60, 64)	11.0	14.0		13.5
60			11.0	14.0		
62	(60, 64)		11.0	14.0	16.0	
64			11.0	14.0		
100			11.0	14.0		
102	(100, 104)		11.0	14.0	16.0	
104			11.0	14.0		
106		(100, 104, 108, 112)	11.0	14.0		12.0
108			11.0	14.0		
110			11.0	14.0	16.0	
112			11.0	14.0		
114			11.0	14.0		
116			11.0	14.0		
118	(116, 120)		11.0	14.0	16.0	
120			11.0	14.0		
122		(116, 120, 124, 128)	11.0	14.0		
124			11.0	14.0		
126	(124, 128)		11.0	14.0	16.0	

<b>20 MHZ CHANNEL</b>	<b>40 MHZ CHANNEL</b>	<b>80 MHZ CHANNELS</b>	<b>LEGACY OFDM RATES (6,9,12,18,24,36,48,54 MBPS)</b>	<b>802.11n HT20 RATES (MCS 0 MCS 15)</b>	<b>802.11n HT40 RATES (MCS 0 MCS 15)</b>	<b>802.11n HT80 RATES (MCS 0 MCS 15)</b>
128			11.0	14.0		
130			11.0	14.0		
132			11.0	14.0		
134	(132, 136)		11.0	14.0	13.0	
136			11.0	14.0		
138			11.0	14.0		
140			11.0	14.0		
142			11.0	14.0	14.45	
144			11.0	14.0		
149			20.0	20.0		
151	(149, 153)		20.0	20.0	20.0	
153			20.0	20.0		
155		(149, 153, 157, 161)	20.0	20.0		20.0
157			20.0	20.0		
159	(157, 161)		20.0	20.0	20.0	
161			20.0	20.0		
165			20.0	20.0		

Facade antenna, peak gain = 4.0dBi

## 20.3 EU Regulatory Domain 2.4 GHz Band

### 20.3.1 External Dipole Antenna Model

The following is a transmit power table (EU domain) per external dipole antenna in the 2.4 GHz band:

<b>20 MHZ CHANNEL</b>	<b>40 MHZ CHANNEL</b>	<b>LEGACY DSSS RATES (1, 2, 5.5, 11 MBPS)</b>	<b>LEGACY OFDM RATES (6,9,12,18,24,36, 48,54 MBPS)</b>	<b>802.11n HT20 RATES (MCS 0 MCS 15)</b>	<b>802.11n HT40 RATES (MCS 0 MCS15)</b>
1		4.5	4.5	4.5	
2		4.5	4.5	4.5	
3	(1, 5)	4.5	4.5	4.5	4.5
4	(2, 6)	4.5	4.5	4.5	4.5
5	(3, 7)	4.5	4.5	4.5	4.5
6	(4, 8)	4.5	4.5	4.5	4.5
7	(5, 9)	4.5	4.5	4.5	4.5
8	(6, 10)	4.5	4.5	4.5	4.5
9	(7, 11)	4.5	4.5	4.5	4.5
10	(8, 12)	4.5	4.5	4.5	4.5
11	(9, 13)	4.5	4.5	4.5	4.5
12		4.5	4.5	4.5	
13		4.5	4.5	4.5	
14					

External dipole antenna, peak gain = 10.5dBi



### 20.3.2 External Panel Antenna Model

The following is a transmit power table (EU domain) per external panel antenna in the 2.4 GHz band:

<b>20 MHZ CHANNEL</b>	<b>40 MHZ CHANNEL</b>	<b>LEGACY DSSS RATES (1, 2, 5.5, 11 MBPS)</b>	<b>LEGACY OFDM RATES (6,9,12,18,24,36, 48,54 MBPS)</b>	<b>802.11n HT20 RATES (MCS 0 MCS 15)</b>	<b>802.11n HT40 RATES (MCS 0 MCS15)</b>
1		4.0	4.0	4.0	
2		4.0	4.0	4.0	
3	(1, 5)	4.0	4.0	4.0	4.0
4	(2, 6)	4.0	4.0	4.0	4.0
5	(3, 7)	4.0	4.0	4.0	4.0
6	(4, 8)	4.0	4.0	4.0	4.0
7	(5, 9)	4.0	4.0	4.0	4.0
8	(6, 10)	4.0	4.0	4.0	4.0
9	(7, 11)	4.0	4.0	4.0	4.0
10	(8, 12)	4.0	4.0	4.0	4.0
11	(9, 13)	4.0	4.0	4.0	4.0
12		4.0	4.0	4.0	
13		4.0	4.0	4.0	
14					

External panel antenna, peak gain = 11dBi

### 20.3.3 External Patch Antenna Model

The following is a transmit power table (EU domain) per external patch antenna in the 2.4 GHz band:

<b>20 MHZ CHANNEL</b>	<b>40 MHZ CHANNEL</b>	<b>LEGACY DSSS RATES (1, 2, 5.5, 11 MBPS)</b>	<b>LEGACY OFDM RATES (6,9,12,18,24,36, 48,54 MBPS)</b>	<b>802.11n HT20 RATES (MCS 0 MCS 15)</b>	<b>802.11n HT40 RATES (MCS 0 MCS15)</b>
1		11.0	11.0	11.0	
2		11.0	11.0	11.0	
3	(1, 5)	11.0	11.0	11.0	11.0
4	(2, 6)	11.0	11.0	11.0	11.0
5	(3, 7)	11.0	11.0	11.0	11.0
6	(4, 8)	11.0	11.0	11.0	11.0
7	(5, 9)	11.0	11.0	11.0	11.0
8	(6, 10)	11.0	11.0	11.0	11.0
9	(7, 11)	11.0	11.0	11.0	11.0
10		11.0	11.0	11.0	
11		11.0	11.0	11.0	
12					
13					
14					

External patch antenna, peak gain = 4dBi

### 20.3.4 Facade Antenna Model

The following is a transmit power table (EU domain) per internal facade antenna in the 2.4 GHz band:

<b>20 MHZ CHANNEL</b>	<b>40 MHZ CHANNEL</b>	<b>LEGACY DSSS RATES (1, 2, 5.5, 11 MBPS)</b>	<b>LEGACY OFDM RATES (6,9,12,18,24,36, 48,54 MBPS)</b>	<b>802.11n HT20 RATES (MCS 0 MCS 15)</b>	<b>802.11n HT40 RATES (MCS 0 MCS15)</b>
1		11.5	11.5	11.5	
2		11.5	11.5	11.5	
3	(1, 5)	11.5	11.5	11.5	11.5
4	(2, 6)	11.5	11.5	11.5	11.5
5	(3, 7)	11.5	11.5	11.5	11.5
6	(4, 8)	11.5	11.5	11.5	11.5
7	(5, 9)	11.5	11.5	11.5	11.5
8	(6, 10)	11.5	11.5	11.5	11.5
9	(7, 11)	11.5	11.5	11.5	11.5
10		11.5	11.5	11.5	
11		11.5	11.5	11.5	
12					
13					
14					

Facade antenna, peak gain = 3.5dBi

## 20.4 EU Regulatory Domain 5 GHz Band

### 20.4.1 External Dipole Antenna Model

The following is a transmit power table (EU domain) per external dipole antenna in the 5 GHz band:

<b>20 MHZ CHANNEL</b>	<b>40 MHZ CHANNEL</b>	<b>80 MHZ CHANNELS</b>	<b>LEGACY OFDM RATES (6,9,12,18,24,36,48,54 MBPS)</b>	<b>802.11n HT20 RATES (MCS 0 MCS 15)</b>	<b>802.11n HT40 RATES (MCS 0 MCS 15)</b>	<b>802.11n HT80RATES (MCS 0 MCS 15)</b>
36			7.5	7.5		
38	(36, 40)		7.5	7.5	7.5	
40			7.5	7.5		
42		(36, 40, 44, 48)	7.5	7.5		7.5
44			7.5	7.5		
46	(44, 48)		7.5	7.5	7.5	
48			7.5	7.5		
52			4.5	4.5		
54	(52, 56)		4.5	4.5	4.5	
56			4.5	4.5		
58		(52, 56, 60, 64)	4.5	4.5		4.5
60			4.5	4.5		
62	(60, 64)		4.5	4.5	4.5	
64			4.5	4.5		
100			11.5	11.5		
102	(100, 104)		11.5	11.5	11.5	
104			11.5	11.5		
106		(100, 104, 108, 112)	11.5	11.5		11.5
108			11.5	11.5		
110			11.5	11.5	11.5	
112			11.5	11.5		
114			11.5	11.5		
116			11.5	11.5		
118	(116, 120)		11.5	11.5	11.5	
120			11.5	11.5		
122		(116, 120, 124, 128)	11.5	11.5		11.5

<b>20 MHZ CHANNEL</b>	<b>40 MHZ CHANNEL</b>	<b>80 MHZ CHANNES</b>	<b>LEGACY OFDM RATES (6,9,12,18,24,36, 48,54 MBPS)</b>	<b>802.11n HT20 RATES (MCS 0 MCS 15)</b>	<b>802.11n HT40 RATES (MCS 0 MCS 15)</b>	<b>802.11n HT80RATES (MCS 0 MCS 15)</b>
124			11.5	11.5		
126	(124, 128)		11.5	11.5		
128			11.5	11.5		
130			11.5	11.5		
132			11.5	11.5		
134	(132, 136)		11.5	11.5	11.5	
136			11.5	11.5		
138			11.5	11.5		
140			11.5	11.5		
142			11.5	11.5	11.5	
144			11.5	11.5		
149						
151	(149, 153)					
153						
155		(149, 153, 157, 161)				
157						
159	(157, 161)					
161						
165						

External dipole antenna, peak gain = 10.5dBi

## 20.4.2 External Panel Antenna Model

The following is a transmit power table (EU domain) per external panel antenna in the 5 GHz band:

<b>20 MHZ CHANNEL</b>	<b>40 MHZ CHANNEL</b>	<b>80 MHZ CHANNELS</b>	<b>LEGACY OFDM RATES (6,9,12,18,24,36,48,54 MBPS)</b>	<b>802.11n HT20 RATES (MCS 0 MCS 15)</b>	<b>802.11n HT40 RATES (MCS 0 MCS 15)</b>	<b>802.11n HT80RATES (MCS 0 MCS 15)</b>
36			4.0	4.0		
38	(36, 40)		4.0	4.0	4.0	
40			4.0	4.0		
42		(36, 40, 44, 48)	4.0	4.0		4.0
44			4.0	4.0		
46	(44, 48)		4.0	4.0	4.0	
48			4.0	4.0		
52			1.0	1.0		
54	(52, 56)		1.0	1.0	1.0	1.0
56			1.0	1.0		
58		(52, 56, 60, 64)	1.0	1.0		1.0
60			1.0	1.0		
62	(60, 64)		1.0	1.0	1.0	
64			1.0	1.0		
100			8.0	8.0		
102	(100, 104)		8.0	8.0	8.0	
104			8.0	8.0		
106		(100, 104, 108, 112)	8.0	8.0		8.0
108			8.0	8.0		
110			8.0	8.0	8.0	
112			8.0	8.0		
114			8.0	8.0		
116			8.0	8.0		
118	(116, 120)		8.0	8.0	8.0	
120			8.0	8.0		
122		(116, 120, 124, 128)	8.0	8.0		8.0
124			8.0	8.0		
126	(124, 128)		8.0	8.0	8.0	

<b>20 MHZ CHANNEL</b>	<b>40 MHZ CHANNEL</b>	<b>80 MHZ CHANNELS</b>	<b>LEGACY OFDM RATES (6,9,12,18,24,36,48,54 MBPS)</b>	<b>802.11n HT20 RATES (MCS 0 MCS 15)</b>	<b>802.11n HT40 RATES (MCS 0 MCS 15)</b>	<b>802.11n HT80RATES (MCS 0 MCS 15)</b>
128			8.0	8.0		
130			8.0	8.0		
132			8.0	8.0		
134	(132, 136)		8.0	8.0	8.0	
136			8.0	8.0		
138			8.0	8.0		
140			8.0	8.0		
142			8.0	8.0	8.0	
144			8.0	8.0		
149						
151	(149, 153)					
153						
155		(149, 153, 157, 161)				
157						
159	(157, 161)					
161						
165						

External panel antenna, peak gain = 14dBi

### 20.4.3 External Yagi Antenna Model

The following is a transmit power table (EU domain) per external yagi antenna in the 5 GHz band:

<b>20 MHZ CHANNEL</b>	<b>40 MHZ CHANNEL</b>	<b>80 MHZ CHANNELS</b>	<b>LEGACY OFDM RATES (6,9,12,18,24,36,48,54 MBPS)</b>	<b>802.11n HT20 RATES (MCS 0 MCS 15)</b>	<b>802.11n HT40 RATES (MCS 0 MCS 15)</b>	<b>802.11n HT80RATES (MCS 0 MCS 15)</b>
36			7.5	7.5		
38	(36, 40)		7.5	7.5	7.5	
40			7.5	7.5		
42		(36, 40, 44, 48)	7.5	7.5		7.5
44			7.5	7.5		
46	(44, 48)		7.5	7.5	7.5	
48			7.5	7.5		
52			4.5	4.5		
54	(52, 56)		4.5	4.5	4.5	
56			4.5	4.5		
58		(52, 56, 60, 64)	4.5	4.5		4.5
60			4.5	4.5		
62	(60, 64)		4.5	4.5	4.5	
64			4.5	4.5		
100			11.5	11.5		
102	(100, 104)		11.5	11.5	11.5	
104			11.5	11.5		
106		(100, 104, 108, 112)	11.5	11.5		11.5
108			11.5	11.5		
110			11.5	11.5	11.5	
112			11.5	11.5		
114			11.5	11.5		
116			11.5	11.5		
118	(116, 120)		11.5	11.5	11.5	
120			11.5	11.5		
122		(116, 120, 124, 128)	11.5	11.5		11.5
124			11.5	11.5		
126	(124, 128)		11.5	11.5	11.5	



<b>20 MHZ CHANNEL</b>	<b>40 MHZ CHANNEL</b>	<b>80 MHZ CHANNELS</b>	<b>LEGACY OFDM RATES (6,9,12,18,24,36,48,54 MBPS)</b>	<b>802.11n HT20 RATES (MCS 0 MCS 15)</b>	<b>802.11n HT40 RATES (MCS 0 MCS 15)</b>	<b>802.11n HT80RATES (MCS 0 MCS 15)</b>
128			11.5	11.5		
130			11.5	11.5		
132			11.5	11.5		
134	(132, 136)		11.5	11.5	11.5	
136			11.5	11.5		
138			11.5	11.5		
140			11.5	11.5		
142			11.5	11.5	11.5	
144			11.5	11.5		
149						
151	(149, 153)					
153						
155		(149, 153, 157, 161)				
157						
159	(157, 161)					
161						
165						

External yagi antenna, peak gain = 10.5dBi

### 20.4.4 External Patch Antenna Model

The following is a transmit power table (EU domain) per external patch antenna in the 5 GHz band:

<b>20 MHZ CHANNEL</b>	<b>40 MHZ CHANNEL</b>	<b>80 MHZ CHANNELS</b>	<b>LEGACY OFDM RATES (6,9,12,18,24,36,48,54 MBPS)</b>	<b>802.11n HT20 RATES (MCS 0 MCS 15)</b>	<b>802.11n HT40 RATES (MCS 0 MCS 15)</b>	<b>802.11n HT80RATES (MCS 0 MCS 15)</b>
36			14.5	14.5		
38	(36, 40)		14.5	14.5	14.5	
40			14.5	14.5		
42		(36, 40, 44, 48)	14.5	14.5		14.5
44			14.5	14.5		
46	(44, 48)		14.5	14.5	14.5	
48			14.5	14.5		
52			11.5	11.5		
54	(52, 56)		11.5	11.5	11.5	
56			11.5	11.5		
58		(52, 56, 60, 64)	11.5	11.5		11.5
60			11.5	11.5		
62	(60, 64)		11.5	11.5	11.5	
64			11.5	11.5		
100			18.0	18.0		
102	(100, 104)		18.0	18.0	18.0	
104			18.0	18.0		
106		(100, 104, 108, 112)	18.0	18.0		18.0
108			18.0	18.0		
110			18.0	18.0	18.0	
112			18.0	18.0		
114			18.0	18.0		
116			18.0	18.0		
118	(116, 120)		18.0	18.0	18.0	
120			18.0	18.0		
122		(116, 120, 124, 128)	18.0	18.0		18.0
124			18.0	18.0		
126	(124, 128)		18.0	18.0	18.0	

<b>20 MHZ CHANNEL</b>	<b>40 MHZ CHANNEL</b>	<b>80 MHZ CHANNELS</b>	<b>LEGACY OFDM RATES (6,9,12,18,24,36, 48,54 MBPS)</b>	<b>802.11n HT20 RATES (MCS 0 MCS 15)</b>	<b>802.11n HT40 RATES (MCS 0 MCS 15)</b>	<b>802.11n HT80RATES (MCS 0 MCS 15)</b>
128			18.0	18.0		
130			18.0	18.0		
132			18.0	18.0		
134	(132, 136)		18.0	18.0	18.0	
136			18.0	18.0		
138			18.0	18.0		
140			18.0	18.0		
142			18.0	18.0	18.0	
144			18.0	18.0		
149			18.0	18.0		
151	(149, 153)					
153						
155		(149, 153, 157, 161)				
157						
159	(157, 161)					
161						
165						

External patch antenna, peak gain = 3.8dBi

## 20.4.5 Facade Antenna Model

The following is a transmit power table (EU domain) per external facade antenna in the 5 GHz band:

<b>20 MHZ CHANNEL</b>	<b>40 MHZ CHANNEL</b>	<b>80 MHZ CHANNELS</b>	<b>LEGACY OFDM RATES (6,9,12,18,24,36,48,54 MBPS)</b>	<b>802.11n HT20 RATES (MCS 0 MCS 15)</b>	<b>802.11n HT40 RATES (MCS 0 MCS 15)</b>	<b>802.11n HT80RATES (MCS 0 MCS 15)</b>
36			14.5	14.5		
38	(36, 40)		14.5	14.5	14.5	
40			14.5	14.5		
42		(36, 40, 44, 48)	14.5	14.5		14.5
44			14.5	14.5		
46	(44, 48)		14.5	14.5	14.5	
48			14.5	14.5		
52			11.5	11.5		
54	(52, 56)		11.5	11.5	11.5	
56			11.5	11.5		
58		(52, 56, 60, 64)	11.5	11.5		11.5
60			11.5	11.5		
62	(60, 64)		11.5	11.5	11.5	
64			11.5	11.5		
100			18.0	18.0		
102	(100, 104)		18.0	18.0	18.0	
104			18.0	18.0		
106		(100, 104, 108, 112)	18.0	18.0		18.0
108			18.0	18.0		
110			18.0	18.0	18.0	
112			18.0	18.0		
114			18.0	18.0		
116			18.0	18.0		
118	(116, 120)		18.0	18.0	18.0	
120			18.0	18.0		
122		(116, 120, 124, 128)	18.0	18.0		18.0
124			18.0	18.0		
126	(124, 128)		18.0	18.0	18.0	

<b>20 MHZ CHANNEL</b>	<b>40 MHZ CHANNEL</b>	<b>80 MHZ CHANNELS</b>	<b>LEGACY OFDM RATES (6,9,12,18,24,36, 48,54 MBPS)</b>	<b>802.11n HT20 RATES (MCS 0 MCS 15)</b>	<b>802.11n HT40 RATES (MCS 0 MCS 15)</b>	<b>802.11n HT80RATES (MCS 0 MCS 15)</b>
128			18.0	18.0		
130			18.0	18.0		
132			18.0	18.0		
134	(132, 136)		18.0	18.0	18.0	
136			18.0	18.0		
138			18.0	18.0		
140			18.0	18.0		
142			18.0	18.0	18.0	
144			18.0	18.0		
149						
151	(149, 153)					
153						
155		(149, 153, 157, 161)				
157						
159	(157, 161)					
161						
165						

Facade antenna, peak gain = 4dBi

## 20.5 Japan Regulatory Domain 2.4 GHz Band

### 20.5.1 External Dipole Antenna Model

The following is a transmit power table (Japanese domain) per external dipole antenna in the 2.4 GHz band:

<b>20 MHZ CHANNEL</b>	<b>40 MHZ CHANNEL</b>	<b>LEGACY DSSS RATES (1, 2, 5.5, 11 MBPS)</b>	<b>LEGACY OFDM RATES (6,9,12,18,24,36, 48,54 MBPS)</b>	<b>802.11n HT20 RATES (MCS 0 MCS 15)</b>	<b>802.11n HT40 RATES (MCS 0 MCS15)</b>
1		8.0	9.0	4.5	
2		8.0	9.0	9.0	
3	(1, 5)	8.0	9.0	9.0	9.0
4	(2, 6)	8.0	9.0	9.0	9.0
5	(3, 7)	8.0	9.0	9.0	9.0
6	(4, 8)	8.0	9.0	9.0	9.0
7	(5, 9)	8.0	9.0	9.0	9.0
8	(6, 10)	8.0	9.0	9.0	9.0
9	(7, 11)	8.0	9.0	9.0	9.0
10	(8, 12)	8.0	9.0	9.0	9.0
11	(9, 13)	8.0	9.0	9.0	9.0
12		8.0	9.0	9.0	
13		8.0	9.0	9.0	
14					

External dipole antenna, peak gain = 10.5dBi

## 20.5.2 External Panel Antenna Model

The following is a transmit power table (Japanese domain) per external panel antenna in the 2.4 GHz band:

<b>20 MHZ CHANNEL</b>	<b>40 MHZ CHANNEL</b>	<b>LEGACY DSSS RATES (1, 2, 5.5, 11 MBPS)</b>	<b>LEGACY OFDM RATES (6,9,12,18,24,36, 48,54 MBPS)</b>	<b>802.11n HT20 RATES (MCS 0 MCS 15)</b>	<b>802.11n HT40 RATES (MCS 0 MCS15)</b>
1		13.0	14.0	14.0	
2		13.0	14.0	14.0	
3	(1, 5)	13.0	14.0	14.0	14.0
4	(2, 6)	13.0	14.0	14.0	14.0
5	(3, 7)	13.0	14.0	14.0	14.0
6	(4, 8)	13.0	14.0	14.0	14.0
7	(5, 9)	13.0	14.0	14.0	14.0
8	(6, 10)	13.0	14.0	14.0	14.0
9	(7, 11)	13.0	14.0	14.0	14.0
10	(8, 12)	13.0	14.0	14.0	14.0
11	(9, 13)	13.0	14.0	14.0	14.0
12		13.0	14.0	14.0	
13		13.0	14.0	14.0	
14					

External panel antenna, peak gain = 15dBi

### 20.5.3 External Yagi Antenna Model

The following is a transmit power table (Japanese domain) per external patch antenna in the 2.4 GHz band:

<b>20 MHZ CHANNEL</b>	<b>40 MHZ CHANNEL</b>	<b>LEGACY DSSS RATES (1, 2, 5.5, 11 MBPS)</b>	<b>LEGACY OFDM RATES (6,9,12,18,24,36, 48,54 MBPS)</b>	<b>802.11n HT20 RATES (MCS 0 MCS 15)</b>	<b>802.11n HT40 RATES (MCS 0 MCS15)</b>
1		14.0	15.0	15.0	
2		14.0	15.0	15.0	
3	(1, 5)	14.0	15.0	15.0	15.0
4	(2, 6)	14.0	15.0	15.0	15.0
5	(3, 7)	14.0	15.0	15.0	15.0
6	(4, 8)	14.0	15.0	15.0	15.0
7	(5, 9)	14.0	15.0	15.0	15.0
8	(6, 10)	14.0	15.0	15.0	15.0
9	(7, 11)	14.0	15.0	15.0	15.0
10		14.0	15.0	15.0	
11		14.0	15.0	15.0	
12					
13					
14					

External patch antenna, peak gain = 14.5dBi



### 20.5.4 External Patch Antenna Model

The following is a transmit power table (Japanese domain) per external patch antenna in the 2.4 GHz band:

<b>20 MHZ CHANNEL</b>	<b>40 MHZ CHANNEL</b>	<b>LEGACY DSSS RATES (1, 2, 5.5, 11 MBPS)</b>	<b>LEGACY OFDM RATES (6,9,12,18,24,36, 48,54 MBPS)</b>	<b>802.11n HT20 RATES (MCS 0 MCS 15)</b>	<b>802.11n HT40 RATES (MCS 0 MCS15)</b>
1		14.0	15.0	15.0	
2		14.0	15.0	15.0	
3	(1, 5)	14.0	15.0	15.0	15.0
4	(2, 6)	14.0	15.0	15.0	15.0
5	(3, 7)	14.0	15.0	15.0	15.0
6	(4, 8)	14.0	15.0	15.0	15.0
7	(5, 9)	14.0	15.0	15.0	15.0
8	(6, 10)	14.0	15.0	15.0	15.0
9	(7, 11)	14.0	15.0	15.0	15.0
10		14.0	15.0	15.0	
11		14.0	15.0	15.0	
12					
13					
14					

External patch antenna, peak gain = 4dBi

### 20.5.5 Facade Antenna Model

The following is a transmit power table (Japanese domain) per internal facade antenna in the 2.4 GHz band:

<b>20 MHZ CHANNEL</b>	<b>40 MHZ CHANNEL</b>	<b>LEGACY DSSS RATES (1, 2, 5.5, 11 MBPS)</b>	<b>LEGACY OFDM RATES (6,9,12,18,24,36, 48,54 MBPS)</b>	<b>802.11n HT20 RATES (MCS 0 MCS 15)</b>	<b>802.11n HT40 RATES (MCS 0 MCS15)</b>
1		15.0	15.0	15.0	
2		15.0	15.0	15.0	
3	(1, 5)	15.0	15.0	15.0	15.0
4	(2, 6)	15.0	15.0	15.0	15.0
5	(3, 7)	15.0	15.0	15.0	15.0
6	(4, 8)	15.0	15.0	15.0	15.0
7	(5, 9)	15.0	15.0	15.0	15.0
8	(6, 10)	15.0	15.0	15.0	15.0
9	(7, 11)	15.0	15.0	15.0	15.0
10		15.0	15.0	15.0	
11		15.0	15.0	15.0	
12					
13					
14					

Facade antenna, peak gain = 3.5dBi

## 20.6 Japan Regulatory Domain 5 GHz Band

### 20.6.1 External Dipole Antenna Model

The following is a transmit power table (Japanese domain) per external dipole antenna in the 5 GHz band:

<b>20 MHZ CHANNEL</b>	<b>40 MHZ CHANNEL</b>	<b>80 MHZ CHANNELS</b>	<b>LEGACY OFDM RATES (6,9,12,18,24,36, 48,54 MBPS)</b>	<b>802.11n HT20 RATES (MCS 0 MCS 15)</b>	<b>802.11n HT40 RATES (MCS 0 MCS 15)</b>	<b>802.11n HT80RATES (MCS 0 MCS 15)</b>
36			7.0	7.0		
38	(36, 40)		7.0	7.0	7.0	
40			7.0	7.0		
42		(36, 40, 44, 48)	7.0	7.0		7.0
44			7.0	7.0		
46	(44, 48)		7.0	7.0	7.0	
48			7.0	7.0		
52			7.0	7.0		
54	(52, 56)		7.0	7.0	7.0	
56			7.0	7.0		
58		(52, 56, 60, 64)	7.0	7.0		7.0
60			7.0	7.0		
62	(60, 64)		7.0	7.0	7.0	
64			7.0	7.0		
100			14.0	14.0		
102	(100, 104)		14.0	14.0	14.0	
104			14.0	14.0		
106		(100, 104, 108, 112)	14.0	14.0		14.0
108			14.0	14.0		
110			14.0	14.0	14.0	
112			14.0	14.0		
114			14.0	14.0		
116			14.0	14.0		
118	(116, 120)		14.0	14.0	14.0	
120			14.0	14.0		
122		(116, 120, 124, 128)	14.0	14.0		14.0

<b>20 MHZ CHANNEL</b>	<b>40 MHZ CHANNEL</b>	<b>80 MHZ CHANNELS</b>	<b>LEGACY OFDM RATES (6,9,12,18,24,36,48,54 MBPS)</b>	<b>802.11n HT20 RATES (MCS 0 MCS 15)</b>	<b>802.11n HT40 RATES (MCS 0 MCS 15)</b>	<b>802.11n HT80RATES (MCS 0 MCS 15)</b>
124			14.0	14.0		
126	(124, 128)		14.0	14.0		
128			14.0	14.0		
130			14.0	14.0		
132			14.0	14.0		
134	(132, 136)		14.0	14.0	14.0	
136			14.0	14.0		
138			14.0	14.0		
140			14.0	14.0		
142			14.0	14.0	14.0	
144			14.0	14.0		
149						
151	(149, 153)					
153						
155		(149, 153, 157, 161)				
157						
159	(157, 161)					
161						
165						

External dipole antenna, peak gain = 10.5dBi

## 20.6.2 External Panel Antenna Model

The following is a transmit power table (Japanese domain) per external panel antenna in the 5 GHz band:

<b>20 MHZ CHANNEL</b>	<b>40 MHZ CHANNEL</b>	<b>80 MHZ CHANNELS</b>	<b>LEGACY OFDM RATES (6,9,12,18,24,36,48,54 MBPS)</b>	<b>802.11n HT20 RATES (MCS 0 MCS 15)</b>	<b>802.11n HT40 RATES (MCS 0 MCS 15)</b>	<b>802.11n HT80RATES (MCS 0 MCS 15)</b>
36			3.0	3.0		
38	(36, 40)		3.0	3.0	3.0	
40			3.0	3.0		
42		(36, 40, 44, 48)	3.0	3.0		3.0
44			3.0	3.0		
46	(44, 48)		3.0	3.0	3.0	
48			3.0	3.0		
52			3.0	3.0		
54	(52, 56)		3.0	3.0	3.0	3.0
56			3.0	3.0		
58		(52, 56, 60, 64)	3.0	3.0		3.0
60			3.0	3.0		
62	(60, 64)		3.0	3.0	3.0	
64			3.0	3.0		
100			10.0	10.0		
102	(100, 104)		10.0	10.0	10.0	
104			10.0	10.0		
106		(100, 104, 108, 112)	10.0	10.0		10.0
108			10.0	10.0		
110			10.0	10.0	10.0	
112			10.0	10.0		
114			10.0	10.0		
116			10.0	10.0		
118	(116, 120)		10.0	10.0	10.0	
120			10.0	10.0		
122		(116, 120, 124, 128)	10.0	10.0		10.0
124			10.0	10.0		
126	(124, 128)		10.0	10.0	10.0	

<b>20 MHZ CHANNEL</b>	<b>40 MHZ CHANNEL</b>	<b>80 MHZ CHANNELS</b>	<b>LEGACY OFDM RATES (6,9,12,18,24,36,48,54 MBPS)</b>	<b>802.11n HT20 RATES (MCS 0 MCS 15)</b>	<b>802.11n HT40 RATES (MCS 0 MCS 15)</b>	<b>802.11n HT80RATES (MCS 0 MCS 15)</b>
128			10.0	10.0		
130			10.0	10.0		
132			10.0	10.0		
134	(132, 136)		10.0	10.0	10.0	
136			10.0	10.0		
138			10.0	10.0		
140			10.0	10.0		
142			10.0	10.0	10.0	
144			10.0	10.0		
149						
151	(149, 153)					
153						
155		(149, 153, 157, 161)				
157						
159	(157, 161)					
161						
165						

External panel antenna, peak gain = 14dBi

### 20.6.3 External Yagi Antenna Model

The following is a transmit power table (Japanese domain) per external yagi antenna in the 5 GHz band:

<b>20 MHZ CHANNEL</b>	<b>40 MHZ CHANNEL</b>	<b>80 MHZ CHANNELS</b>	<b>LEGACY OFDM RATES (6,9,12,18,24,36,48,54 MBPS)</b>	<b>802.11n HT20 RATES (MCS 0 MCS 15)</b>	<b>802.11n HT40 RATES (MCS 0 MCS 15)</b>	<b>802.11n HT80RATES (MCS 0 MCS 15)</b>
36			7.0	7.0		
38	(36, 40)		7.0	7.0	7.0	
40			7.0	7.0		
42		(36, 40, 44, 48)	7.0	7.0		7.0
44			7.0	7.0		
46	(44, 48)		7.0	7.0	7.0	
48			7.0	7.0		
52			7.0	7.0		
54	(52, 56)		7.0	7.0	7.0	
56			7.0	7.0		
58		(52, 56, 60, 64)	7.0	7.0		7.0
60			7.0	7.0		
62	(60, 64)		7.0	7.0	7.0	
64			7.0	7.0		
100			14.0	14.0		
102	(100, 104)		14.0	14.0	14.0	
104			14.0	14.0		
106		(100, 104, 108, 112)	14.0	14.0		14.0
108			14.0	14.0		
110			14.0	14.0	14.0	
112			14.0	14.0		
114			14.0	14.0		
116			14.0	14.0		
118	(116, 120)		14.0	14.0	14.0	
120			14.0	14.0		
122		(116, 120, 124, 128)	14.0	14.0		14.0
124			14.0	14.0		
126	(124, 128)		14.0	14.0	14.0	

<b>20 MHZ CHANNEL</b>	<b>40 MHZ CHANNEL</b>	<b>80 MHZ CHANNELS</b>	<b>LEGACY OFDM RATES (6,9,12,18,24,36,48,54 MBPS)</b>	<b>802.11n HT20 RATES (MCS 0 MCS 15)</b>	<b>802.11n HT40 RATES (MCS 0 MCS 15)</b>	<b>802.11n HT80RATES (MCS 0 MCS 15)</b>
128			14.0	14.0		
130			14.0	14.0		
132			14.0	14.0		
134	(132, 136)		14.0	14.0	14.0	
136			14.0	14.0		
138			14.0	14.0		
140			14.0	14.0		
142			14.0	14.0	14.0	
144			14.0	14.0		
149						
151	(149, 153)					
153						
155		(149, 153, 157, 161)				
157						
159	(157, 161)					
161						
165						

External yagi antenna, peak gain = 10.5dBi



## 20.6.4 External Patch Antenna Model

The following is a transmit power table (Japanese domain) per external patch antenna in the 5 GHz band:

<b>20 MHZ CHANNEL</b>	<b>40 MHZ CHANNEL</b>	<b>80 MHZ CHANNELS</b>	<b>LEGACY OFDM RATES (6,9,12,18,24,36,48,54 MBPS)</b>	<b>802.11n HT20 RATES (MCS 0 MCS 15)</b>	<b>802.11n HT40 RATES (MCS 0 MCS 15)</b>	<b>802.11n HT80RATES (MCS 0 MCS 15)</b>
36			13.0	13.0		
38	(36, 40)		13.0	13.0	13.0	
40			13.0	13.0		
42		(36, 40, 44, 48)	13.0	13.0		13.0
44			13.0	13.0		
46	(44, 48)		13.0	13.0	13.0	
48			13.0	13.0		
52			13.0	13.0		
54	(52, 56)		13.0	13.0	13.0	
56			13.0	13.0		
58		(52, 56, 60, 64)	13.0	13.0		13.0
60			13.0	13.0		
62	(60, 64)		13.0	13.0	13.0	
64			13.0	13.0		
100			20.0	20.0		
102	(100, 104)		20.0	20.0	20.0	
104			20.0	20.0		
106		(100, 104, 108, 112)	20.0	20.0		20.0
108			20.0	20.0		
110			20.0	20.0	20.0	
112			20.0	20.0		
114			20.0	20.0		
116			20.0	20.0		
118	(116, 120)		20.0	20.0	20.0	
120			20.0	20.0		
122		(116, 120, 124, 128)	20.0	20.0		20.0
124			20.0	20.0		
126	(124, 128)		20.0	20.0	20.0	

<b>20 MHZ CHANNEL</b>	<b>40 MHZ CHANNEL</b>	<b>80 MHZ CHANNELS</b>	<b>LEGACY OFDM RATES (6,9,12,18,24,36,48,54 MBPS)</b>	<b>802.11n HT20 RATES (MCS 0 MCS 15)</b>	<b>802.11n HT40 RATES (MCS 0 MCS 15)</b>	<b>802.11n HT80RATES (MCS 0 MCS 15)</b>
128			20.0	20.0		
130			20.0	20.0		
132			20.0	20.0		
134	(132, 136)		20.0	20.0	20.0	
136			20.0	20.0		
138			20.0	20.0		
140			20.0	20.0		
142			20.0	20.0	20.0	
144			20.0	20.0		
149			20.0	20.0		
151	(149, 153)					
153						
155		(149, 153, 157, 161)				
157						
159	(157, 161)					
161						
165						

External patch antenna, peak gain = 3.8dBi

## 20.6.5 Facade Antenna Model

The following is a transmit power table (Japanese domain) per external facade antenna in the 5 GHz band:

<b>20 MHZ CHANNEL</b>	<b>40 MHZ CHANNEL</b>	<b>80 MHZ CHANNELS</b>	<b>LEGACY OFDM RATES (6,9,12,18,24,36,48,54 MBPS)</b>	<b>802.11n HT20 RATES (MCS 0 MCS 15)</b>	<b>802.11n HT40 RATES (MCS 0 MCS 15)</b>	<b>802.11n HT80RATES (MCS 0 MCS 15)</b>
36			13.0	13.0		
38	(36, 40)		13.0	13.0	13.0	
40			13.0	13.0		
42		(36, 40, 44, 48)	13.0	13.0		13.0
44			13.0	13.0		
46	(44, 48)		13.0	13.0	13.0	
48			13.0	13.0		
52			13.0	13.0		
54	(52, 56)		13.0	13.0	13.0	
56			13.0	13.0		
58		(52, 56, 60, 64)	13.0	13.0		13.0
60			13.0	13.0		
62	(60, 64)		13.0	13.0	13.0	
64			13.0	13.0		
100			20.0	20.0		
102	(100, 104)		20.0	20.0	20.0	
104			20.0	20.0		
106		(100, 104, 108, 112)	20.0	20.0		20.0
108			20.0	20.0		
110			20.0	20.0	20.0	
112			20.0	20.0		
114			20.0	20.0		
116			20.0	20.0		
118	(116, 120)		20.0	20.0	20.0	
120			20.0	20.0		
122		(116, 120, 124, 128)	20.0	20.0		20.0
124			20.0	20.0		
126	(124, 128)		20.0	20.0	20.0	

<b>20 MHZ CHANNEL</b>	<b>40 MHZ CHANNEL</b>	<b>80 MHZ CHANNELS</b>	<b>LEGACY OFDM RATES (6,9,12,18,24,36,48,54 MBPS)</b>	<b>802.11n HT20 RATES (MCS 0 MCS 15)</b>	<b>802.11n HT40 RATES (MCS 0 MCS 15)</b>	<b>802.11n HT80RATES (MCS 0 MCS 15)</b>
128			20.0	20.0		
130			20.0	20.0		
132			20.0	20.0		
134	(132, 136)		20.0	20.0	20.0	
136			20.0	20.0		
138			20.0	20.0		
140			20.0	20.0		
142			20.0	20.0	20.0	
144			20.0	20.0		
149						
151	(149, 153)					
153						
155		(149, 153, 157, 161)				
157						
159	(157, 161)					
161						
165						

Facade antenna, peak gain = 4dBi

## ***AP8222 Regulatory Domains***

### **21.1 US Regulatory Domain 2.4 GHz Band**

#### ***21.1.1 Internal Antenna Maximum Conducted Transmit Power Settings***

The following is a transmit power table (US domain) per internal antenna in the 2.4 GHz band:

<b>20 MHZ CHANNEL</b>	<b>40 MHZ CHANNEL</b>	<b>LEGACY DSSS RATES (1, 2, 5.5, 11 MBPS)</b>	<b>LEGACY OFDM RATES (6,9,12,18,24,36, 48,54 MBPS)</b>	<b>802.11n HT20 RATES (MCS 0 MCS 15)</b>	<b>802.11n HT40 RATES (MCS 0 MCS15)</b>
1		22.5	18.5	15.0	
2		22.0	18.5	15.0	
3	(1, 5)	22.0	23.0	15.0	11.0
4	(2, 6)	22.0	23.0	15.0	11.0
5	(3, 7)	22.0	23.0	15.0	15.0
6	(4, 8)	22.0	23.0	15.0	15.0
7	(5, 9)	22.0	23.0	15.0	15.0
8	(6, 10)	22.0	23.0	15.0	12.0
9	(7, 11)	22.0	23.0	15.0	12.0
10		22.0	17.5	15.0	
11		22.0	17.5	14.0	

Internal antenna, peak gain = 4.3dBi

## 21.2 US Regulatory Domain 5 GHz Band

### 21.2.1 Internal Antenna Model

The following is a transmit power table (US domain) per internal antenna (3x3 mode) in the 5 GHz band:

<b>20 MHZ CHANNEL</b>	<b>40 MHZ CHANNEL</b>	<b>80 MHZ CHANNELS</b>	<b>LEGACY OFDM RATES (6,9,12,18,24,36, 48,54 MBPS)</b>	<b>802.11n HT20 RATES (MCS 0 MCS 15)</b>	<b>802.11n HT40 RATES (MCS 0 MCS 15)</b>	<b>802.11n HT80RATES (MCS 0 MCS 15)</b>
36			9.0	13.0		
38	(36, 40)		9.0	13.0	13.0	
40			9.0	13.0		
42		(36, 40, 44, 48)	9.0	13.0		13.0
44			9.0	13.0		
46	(44, 48)		9.0	13.0	13.0	
48			9.0	13.0		
52			17.0	17.0		
54	(52, 56)		17.0	17.0	17.0	
56			17.0	17.0		
58		(52, 56, 60, 64)	17.0	17.0		12.0
60			17.0	17.0		
62	(60, 64)		17.0	17.0	15.0	
64			17.0	17.0		
100			9.0	13.0		
102	(100, 104)		9.0	13.0	15.5	
104			9.0	13.0		
106		(100, 104, 108, 112)	17.0	17.0		9.0
108			17.0	17.0		
110			17.0	17.0	17.0	
112			17.0	17.0		
114			17.0	17.0		
116			17.0	17.0		
118	(116, 120)		17.0	17.0	17.0	
120			17.0	17.0		
122		(116, 120, 124, 128)	17.0	17.0		

<b>20 MHZ CHANNEL</b>	<b>40 MHZ CHANNEL</b>	<b>80 MHZ CHANNELS</b>	<b>LEGACY OFDM RATES (6,9,12,18,24,36, 48,54 MBPS)</b>	<b>802.11n HT20 RATES (MCS 0 MCS 15)</b>	<b>802.11n HT40 RATES (MCS 0 MCS 15)</b>	<b>802.11n HT80RATES (MCS 0 MCS 15)</b>
124			17.0	17.0		
126	(124, 128)		17.0	17.0	17.0	
128			17.0	17.0		
130			17.0	17.0		
132			17.0	17.0		
134	(132, 136)		17.0	17.0	17.0	
136			17.0	17.0		
138			17.0	17.0		
140			9.0	13.0		
142			9.0	13.0	17.0	
144			9.0	13.0		
149			20.0	20.0		
151	(149, 153)		20.0	20.0	20.0	
153			20.0	20.0		
155		(149, 153, 157, 161)	20.0	20.0		20.0
157			20.0	20.0		
159	(157, 161)		20.0	20.0	20.0	
161			20.0	20.0		
165			20.0	20.0		

External dipole antenna, peak gain = 5.3dBi

## 21.3 EU Regulatory Domain 2.4 GHz Band

### 21.3.1 Internal Antenna Maximum Conducted Transmit Power Settings

The following is a transmit power table (EU domain) per internal antenna in the 2.4 GHz band:

<b>20 MHZ CHANNEL</b>	<b>40 MHZ CHANNEL</b>	<b>LEGACY DSSS RATES (1, 2, 5.5, 11 MBPS)</b>	<b>LEGACY OFDM RATES (6,9,12,18,24,36, 48,54 MBPS)</b>	<b>802.11n HT20 RATES (MCS 0 MCS 15)</b>	<b>802.11n HT40 RATES (MCS 0 MCS15)</b>
1		11.0	11.0	11.0	
2		11.0	11.0	11.0	
3	(1, 5)	11.0	11.0	11.0	11.0
4	(2, 6)	11.0	11.0	11.0	11.0
5	(3, 7)	11.0	11.0	11.0	11.0
6	(4, 8)	11.0	11.0	11.0	11.0
7	(5, 9)	11.0	11.0	11.0	11.0
8	(6, 10)	11.0	11.0	11.0	11.0
9	(7, 11)	11.0	11.0	11.0	11.0
10		11.0	11.0	11.0	11.0
11		11.0	11.0	11.0	11.0
12		11.0	11.0	11.0	
13		11.0	11.0	11.0	
14					

Internal antenna, peak gain = 4.3dBi



## 21.4 EU Regulatory Domain 5 GHz Band

### 21.4.1 Internal Antenna Model

The following is a transmit power table (EU domain) per internal antenna (3x3 mode) in the 5 GHz band:

<b>20 MHZ CHANNEL</b>	<b>40 MHZ CHANNEL</b>	<b>80 MHZ CHANNELS</b>	<b>LEGACY OFDM RATES (6,9,12,18,24,36, 48,54 MBPS)</b>	<b>802.11n HT20 RATES (MCS 0 MCS 15)</b>	<b>802.11n HT40 RATES (MCS 0 MCS 15)</b>	<b>802.11n HT80RATES (MCS 0 MCS 15)</b>
36			12.0	12.0		
38	(36, 40)		12.0	12.0	12.0	
40			12.0	12.0		
42		(36, 40, 44, 48)	12.0	12.0		12.0
44			12.0	12.0		
46	(44, 48)		12.0	12.0	12.0	
48			12.0	12.0		
52			10.0	10.0		
54	(52, 56)		10.0	10.0	10.0	
56			10.0	10.0		
58		(52, 56, 60, 64)	10.0	10.0		10.0
60			10.0	10.0		
62	(60, 64)		10.0	10.0	10.0	
64			10.0	10.0		
100			17.0	17.0		
102	(100, 104)		17.0	17.0	17.0	
104			17.0	17.0		
106		(100, 104, 108, 112)	17.0	17.0		17.0
108			17.0	17.0		
110			17.0	17.0		
112			17.0	17.0		
114			17.0	17.0		
116			17.0	17.0		
118	(116, 120)		17.0	17.0	17.0	
120			17.0	17.0		
122		(116, 120, 124, 128)	17.0	17.0		17.0
124			17.0	17.0		

<b>20 MHZ CHANNEL</b>	<b>40 MHZ CHANNEL</b>	<b>80 MHZ CHANNELS</b>	<b>LEGACY OFDM RATES (6,9,12,18,24,36,48,54 MBPS)</b>	<b>802.11n HT20 RATES (MCS 0 MCS 15)</b>	<b>802.11n HT40 RATES (MCS 0 MCS 15)</b>	<b>802.11n HT80RATES (MCS 0 MCS 15)</b>
126	(124, 128)		17.0	17.0	17.0	
128			17.0	17.0		
130			17.0	17.0		
132			17.0	17.0		
134	(132, 136)		17.0	17.0	17.0	
136			17.0	17.0		
138			17.0	17.0		
140			17.0	17.0		
142			17.0	17.0	17.0	
144			17.0	17.0		
149						
151	(149, 153)					
153						
155		(149, 153, 157, 161)				
157						
159	(157, 161)					
161						
165						

External dipole antenna, peak gain = 5.3dBi

## 21.5 Japan Regulatory Domain 2.4 GHz Band

### 21.5.1 Internal Antenna Maximum Conducted Transmit Power Settings

The following is a transmit power table (Japanese domain) per internal antenna in the 2.4 GHz band:

<b>20 MHZ CHANNEL</b>	<b>40 MHZ CHANNEL</b>	<b>LEGACY DSSS RATES (1, 2, 5.5, 11 MBPS)</b>	<b>LEGACY OFDM RATES (6,9,12,18,24,36, 48,54 MBPS)</b>	<b>802.11n HT20 RATES (MCS 0 MCS 15)</b>	<b>802.11n HT40 RATES (MCS 0 MCS15)</b>
1		13.0	16.0	16.0	
2		13.0	16.0	16.0	
3	(1, 5)	13.0	16.0	16.0	15.0
4	(2, 6)	13.0	16.0	16.0	15.0
5	(3, 7)	13.0	16.0	16.0	15.0
6	(4, 8)	13.0	16.0	16.0	15.0
7	(5, 9)	13.0	16.0	16.0	15.0
8	(6, 10)	13.0	16.0	16.0	15.0
9	(7, 11)	13.0	16.0	16.0	15.0
10		13.0	16.0	16.0	15.0
11		13.0	16.0	16.0	15.0
12		13.0	16.0	16.0	
13		13.0	16.0	16.0	
14					

Internal antenna, peak gain = 4.3dBi

## 21.6 Japan Regulatory Domain 5 GHz Band

### 21.6.1 Internal Antenna Model

The following is a transmit power table (Japanese domain) per internal antenna (3x3 mode) in the 5 GHz band:

<b>20 MHZ CHANNEL</b>	<b>40 MHZ CHANNEL</b>	<b>80 MHZ CHANNELS</b>	<b>LEGACY OFDM RATES (6,9,12,18,24,36,48,54 MBPS)</b>	<b>802.11n HT20 RATES (MCS 0 MCS 15)</b>	<b>802.11n HT40 RATES (MCS 0 MCS 15)</b>	<b>802.11n HT80RATES (MCS 0 MCS 15)</b>
36			13.0	13.0		
38	(36, 40)		13.0	13.0	13.0	
40			13.0	13.0		
42		(36, 40, 44, 48)	13.0	13.0		13.0
44			13.0	13.0		
46	(44, 48)		13.0	13.0	13.0	
48			13.0	13.0		
52			13.0	13.0		
54	(52, 56)		13.0	13.0	13.0	
56			13.0	13.0		
58		(52, 56, 60, 64)	13.0	13.0		13.0
60			13.0	13.0		
62	(60, 64)		13.0	13.0	13.0	
64			13.0	13.0		
100			20.0	20.0		
102	(100, 104)		20.0	20.0	20.0	
104			20.0	20.0		
106		(100, 104, 108, 112)	20.0	20.0		20.0
108			20.0	20.0		
110			20.0	20.0		
112			20.0	20.0		
114			20.0	20.0		
116			20.0	20.0		
118	(116, 120)		20.0	20.0	20.0	
120			20.0	20.0		
122		(116, 120, 124, 128)	20.0	20.0		20.0
124			20.0	20.0		

<b>20 MHZ CHANNEL</b>	<b>40 MHZ CHANNEL</b>	<b>80 MHZ CHANNELS</b>	<b>LEGACY OFDM RATES (6,9,12,18,24,36, 48,54 MBPS)</b>	<b>802.11n HT20 RATES (MCS 0 MCS 15)</b>	<b>802.11n HT40 RATES (MCS 0 MCS 15)</b>	<b>802.11n HT80RATES (MCS 0 MCS 15)</b>
126	(124, 128)		20.0	20.0	20.0	
128			20.0	20.0		
130			20.0	20.0		
132			20.0	20.0		
134	(132, 136)		20.0	20.0	20.0	
136			20.0	20.0		
138			20.0	20.0		
140			20.0	20.0		
142			20.0	20.0	20.0	
144			20.0	20.0		
149						
151	(149, 153)					
153						
155		(149, 153, 157, 161)				
157						
159	(157, 161)					
161						
165						

External dipole antenna, peak gain = 5.3dBi



## ***AP7532 Regulatory Domains***

### **22.1 US Regulatory Domain 2.4 GHz Band**

#### ***22.1.1 External Dipole Antenna Maximum Conducted Transmit Power Settings***

The following is a transmit power table (US domain) per external dipole antenna in the 2.4 GHz band:

<b><i>20 MHZ CHANNEL</i></b>	<b><i>40 MHZ CHANNEL</i></b>	<b><i>LEGACY DSSS RATES (1TX)</i></b>	<b><i>LEGACY OFDM RATES (1TX)</i></b>	<b><i>802.11n HT20 RATES/TURBO QAM (3TX)</i></b>	<b><i>802.11n HT40 RATES/TURBO QAM (3TX)</i></b>
1		20.0	16.0	16.0	
2		20.0	20.0	20.0	
3	(1, 5)	20.0	20.0	20.0	13.0
4	(2, 6)	20.0	20.0	20.0	16.0
5	(3, 7)	20.0	20.0	20.0	16.0
6	(4, 8)	20.0	20.0	20.0	16.0
7	(5, 9)	20.0	20.0	20.0	16.0
8	(6, 10)	20.0	20.0	20.0	16.0
9	(7, 11)	20.0	20.0	20.0	15.0
10		20.0	20.0	20.0	
11		20.0	16.0	16.0	

External dipole antenna, peak gain = 3.17dBi

## 22.1.2 External Panel Antenna Maximum Conducted Transmit Power Settings

The following is a transmit power table (US domain) per external panel antenna in the 2.4 GHz band:



**NOTE:** The use of this panel antenna requires 1ft cable between the AP and the antenna element. If the antenna gain is 4.8dB or less, the cable is not required.

<b>20 MHZ CHANNEL</b>	<b>40 MHZ CHANNEL</b>	<b>LEGACY DSSS RATES (1TX)</b>	<b>LEGACY OFDM RATES (1TX)</b>	<b>802.11n HT20 RATES/TURBO QAM (3TX)</b>	<b>802.11n HT40 RATES/TURBO QAM (3TX)</b>
1		20.0	15.0	15.0	
2		20.0	20.0	20.0	
3	(1, 5)	20.0	20.0	20.0	13.0
4	(2, 6)	20.0	20.0	20.0	16.0
5	(3, 7)	20.0	20.0	20.0	16.0
6	(4, 8)	20.0	20.0	20.0	16.0
7	(5, 9)	20.0	20.0	20.0	16.0
8	(6, 10)	20.0	20.0	20.0	16.0
9	(7, 11)	20.0	20.0	20.0	16.0
10		20.0	20.0	20.0	
11		20.0	16.0	16.0	

External Panel antenna, peak gain = 5.5dBi



### 22.1.3 Internal Antenna Maximum Conducted Transmit Power Settings

The following is a transmit power table (US domain) per internal antenna in the 2.4 GHz band:

<b>20 MHZ CHANNEL</b>	<b>40 MHZ CHANNEL</b>	<b>LEGACY DSSS RATES (1TX)</b>	<b>LEGACY OFDM RATES (1TX)</b>	<b>802.11n HT20 RATES/TURBO QAM (3TX)</b>	<b>802.11n HT40 RATES/TURBO QAM (3TX)</b>
1		20.0	15.0	14.0	
2		19.0	20.0	19.0	
3	(1, 5)	19.0	20.0	19.0	10.0
4	(2, 6)	19.0	20.0	19.0	15.0
5	(3, 7)	19.0	20.0	19.0	15.0
6	(4, 8)	19.0	20.0	19.0	15.0
7	(5, 9)	19.0	20.0	19.0	15.0
8	(6, 10)	19.0	20.0	19.0	15.0
9	(7, 11)	19.0	20.0	19.0	13.0
10		19.0	20.0	19.0	
11		18.0	17.0	18.0	

Internal antenna, peak gain = 4.13dBi

## 22.2 US Regulatory Domain 5 GHz Band

### 22.2.1 External Dipole Antenna Model

The following is a transmit power table (US domain) per external dipole antenna in the 5 GHz band:

<b>20 MHZ CHANNEL</b>	<b>40 MHZ CHANNEL</b>	<b>80 MHZ CHANNELS</b>	<b>LEGACY OFDM RATES (1TX)</b>	<b>802.11n HT20 RATES (3TX)</b>	<b>802.11n HT40 RATES (3TX)</b>	<b>802.11n HT80 RATES (3TX)</b>
36			19.0	17.0		
38	(36, 40)		20.0	16.0	17.0	
40			20.0	16.0		
42		(36, 40, 44, 48)	20.0	16.0		12.0
44			20.0	16.0		
46	(44, 48)		20.0	16.0	17.0	
48			20.0	16.0		
52			19.0	18.0		
54	(52, 56)		19.0	18.0	20.0	
56			20.0	18.0		
58		(52, 56, 60, 64)	20.0	18.0		12.0
60			20.0	18.0		
62	(60, 64)		20.0	18.0	20.0	
64			19.0	17.0		
100			18.0	17.0		
102	(100, 104)		20.0	18.0	15.0	
104			20.0	18.0		
106		(100, 104, 108, 112)	20.0	18.0		15.0
108			20.0	18.0		
110			20.0	18.0	18.0	
112			20.0	18.0		
114			20.0	18.0		
116			20.0	18.0		
118	(116, 120)		20.0	18.0	18.0	
120			20.0	18.0		
122		(116, 120, 124, 128)	20.0	18.0		20.0
124			20.0	18.0		

<b>20 MHZ CHANNEL</b>	<b>40 MHZ CHANNEL</b>	<b>80 MHZ CHANNELS</b>	<b>LEGACY OFDM RATES (1TX)</b>	<b>802.11n HT20 RATES (3TX)</b>	<b>802.11n HT40 RATES (3TX)</b>	<b>802.11n HT80 RATES (3TX)</b>
126	(124, 128)		20.0	18.0	18.0	
128			20.0	18.0		
130			20.0	18.0		
132			20.0	18.0		
134	(132, 136)		20.0	18.0	17.0	
136			20.0	18.0		
138			20.0	18.0		
140			16.0	16.0		
142			16.0	16.0	20.0	
144			20.0	18.0		
149			16.0	16.0		
151	(149, 153)		20.0	16.0	13.0	
153			20.0	16.0		
155		(149, 153, 157, 161)	20.0	16.0		12.0
157			20.0	16.0		
159	(157, 161)		20.0	16.0	15.0	
161			20.0	16.0		
165			17.0	16.0		

External dipole antenna, peak gain = 5dBi

## 22.2.2 External Panel Antenna Model

The following is a transmit power table (US domain) per external panel antenna in the 5 GHz band:



**NOTE:** The use of this panel antenna requires 1ft cable between the AP and the antenna element. If the antenna gain is 4.8dB or less, the cable is not required.

<b>20 MHZ CHANNEL</b>	<b>40 MHZ CHANNEL</b>	<b>80 MHZ CHANNELS</b>	<b>LEGACY OFDM RATES (1TX)</b>	<b>802.11n HT20 RATES (3TX)</b>	<b>802.11n HT40 RATES (3TX)</b>	<b>802.11n HT80 RATES (3TX)</b>
36			19.0	17.0		
38	(36, 40)		20.0	16.0	17.0	
40			20.0	16.0		
42		(36, 40, 44, 48)	20.0	16.0		12.0
44			20.0	16.0		
46	(44, 48)		20.0	16.0	17.0	
48			20.0	16.0		
52			19.0	18.0		
54	(52, 56)		19.0	18.0	20.0	
56			20.0	18.0		
58		(52, 56, 60, 64)	20.0	18.0		12.0
60			20.0	18.0		
62	(60, 64)		20.0	18.0	20.0	
64			19.0	17.0		
100			18.0	17.0		
102	(100, 104)		20.0	18.0	14.0	
104			20.0	18.0		
106		(100, 104, 108, 112)	20.0	18.0		14.0
108			20.0	18.0		
110			20.0	18.0	18.0	
112			20.0	18.0		
114			20.0	18.0		
116			20.0	18.0		
118	(116, 120)		20.0	18.0	18.0	
120			20.0	18.0		
122		(116, 120, 124, 128)	20.0	18.0		20.0
124			20.0	18.0		

<b>20 MHZ CHANNEL</b>	<b>40 MHZ CHANNEL</b>	<b>80 MHZ CHANNELS</b>	<b>LEGACY OFDM RATES (1TX)</b>	<b>802.11n HT20 RATES (3TX)</b>	<b>802.11n HT40 RATES (3TX)</b>	<b>802.11n HT80 RATES (3TX)</b>
126	(124, 128)		20.0	18.0	18.0	
128			20.0	18.0		
130			20.0	18.0		
132			20.0	18.0		
134	(132, 136)		20.0	18.0	17.0	
136			20.0	18.0		
138			20.0	18.0		
140			16.0	16.0		
142			16.0	16.0	20.0	
144			20.0	18.0		
149			16.0	16.0		
151	(149, 153)		20.0	16.0	13.0	
153			20.0	16.0		
155		(149, 153, 157, 161)	20.0	16.0		12.0
157			20.0	16.0		
159	(157, 161)		20.0	16.0	15.0	
161			20.0	16.0		
165			17.0	16.0		

External panel antenna, peak gain = 6dBi

### 22.2.3 Internal Antenna Model

The following is a transmit power table (US domain) per internal antenna in the 5 GHz band:

<b>20 MHZ CHANNEL</b>	<b>40 MHZ CHANNEL</b>	<b>80 MHZ CHANNELS</b>	<b>LEGACY OFDM RATES (1TX)</b>	<b>802.11n HT20 RATES (3TX)</b>	<b>802.11n HT40 RATES (3TX)</b>	<b>802.11n HT80 RATES (3TX)</b>
36			19.0	17.0		
38	(36, 40)		20.0	16.0	17.0	
40			20.0	16.0		
42		(36, 40, 44, 48)	20.0	16.0		12.0
44			20.0	16.0		
46	(44, 48)		20.0	16.0	17.0	
48			20.0	16.0		
52			20.0	14.0		
54	(52, 56)		20.0	14.0	17.0	
56			20.0	14.0		
58		(52, 56, 60, 64)	20.0	14.0		12.0
60			20.0	14.0		
62	(60, 64)		20.0	14.0	17.0	
64			18.0	14.0		
100			17.0	14.0		
102	(100, 104)		20.0	14.0	13.0	
104			20.0	14.0		
106		(100, 104, 108, 112)	20.0	14.0		13.0
108			20.0	14.0		
110			20.0	14.0	15.0	
112			20.0	14.0		
114			20.0	14.0		
116			20.0	14.0		
118	(116, 120)		20.0	14.0	15.0	
120			20.0	14.0		
122		(116, 120, 124, 128)	20.0	14.0		18.0
124			20.0	14.0		
126	(124, 128)		20.0	14.0	15.0	
128			20.0	14.0		
130			20.0	14.0		
132			20.0	14.0		

<b>20 MHZ CHANNEL</b>	<b>40 MHZ CHANNEL</b>	<b>80 MHZ CHANNELS</b>	<b>LEGACY OFDM RATES (1TX)</b>	<b>802.11n HT20 RATES (3TX)</b>	<b>802.11n HT40 RATES (3TX)</b>	<b>802.11n HT80 RATES (3TX)</b>
134	(132, 136)		20.0	14.0	15.0	
136			20.0	14.0		
138			20.0	14.0		
140			16.0	15.0		
142			16.0	15.0	18.0	
144			20.0	15.0		
149			16.0	16.0		
151	(149, 153)		20.0	16.0	13.0	
153			20.0	16.0		
155		(149, 153, 157, 161)	20.0	16.0		12.0
157			20.0	16.0		
159	(157, 161)		20.0	16.0	15.0	
161			20.0	16.0		
165			17.0	16.0		

Internal antenna, peak gain = 5.92dBi

## 22.3 EU Regulatory Domain 2.4 GHz Band

### 22.3.1 External Dipole Antenna Model

The following is a transmit power table (EU domain) per external dipole antenna in the 2.4 GHz band:

<b>20 MHZ CHANNEL</b>	<b>40 MHZ CHANNEL</b>	<b>LEGACY DSSS RATES (1TX)</b>	<b>LEGACY OFDM RATES (1TX)</b>	<b>802.11n HT20 RATES/TURBO QAM (3TX)</b>	<b>802.11n HT40 RATES/TURBO QAM (3TX)</b>
1		17.0	17.0	12.0	
2		17.0	17.0	12.0	
3	(1, 5)	17.0	17.0	12.0	12.0
4	(2, 6)	17.0	17.0	12.0	12.0
5	(3, 7)	17.0	17.0	12.0	12.0
6	(4, 8)	17.0	17.0	12.0	12.0
7	(5, 9)	17.0	17.0	12.0	12.0
8	(6, 10)	17.0	17.0	12.0	12.0
9	(7, 11)	17.0	17.0	12.0	12.0
10	(8, 12)	17.0	17.0	12.0	12.0
11	(9, 13)	17.0	17.0	12.0	12.0
12		17.0	17.0	12.0	
13		17.0	17.0	12.0	
14					

External dipole antenna, peak gain = 3.17dBi



### 22.3.2 External Panel Antenna Model

The following is a transmit power table (EU domain) per external panel antenna in the 2.4 GHz band:



**NOTE:** The use of this panel antenna requires 1ft cable between the AP and the antenna element. If the antenna gain is 5.1dB or less, the cable is not required.

<b>20 MHZ CHANNEL</b>	<b>40 MHZ CHANNEL</b>	<b>LEGACY DSSS RATES (1TX)</b>	<b>LEGACY OFDM RATES (1TX)</b>	<b>802.11n HT20 RATES/TURBO QAM (3TX)</b>	<b>802.11n HT40 RATES/TURBO QAM (3TX)</b>
1		16.0	16.0	11.0	
2		16.0	16.0	11.0	
3	(1, 5)	16.0	16.0	11.0	11.0
4	(2, 6)	16.0	16.0	11.0	11.0
5	(3, 7)	16.0	16.0	11.0	11.0
6	(4, 8)	16.0	16.0	11.0	11.0
7	(5, 9)	16.0	16.0	11.0	11.0
8	(6, 10)	16.0	16.0	11.0	11.0
9	(7, 11)	16.0	16.0	11.0	11.0
10	(8, 12)	16.0	16.0	11.0	11.0
11	(9, 13)	16.0	16.0	11.0	11.0
12		16.0	16.0	11.0	
13		16.0	16.0	11.0	
14					

External panel antenna, peak gain = 5.5dBi

### 22.3.3 Internal Antenna Model

The following is a transmit power table (EU domain) per internal antenna in the 2.4 GHz band:

<b>20 MHZ CHANNEL</b>	<b>40 MHZ CHANNEL</b>	<b>LEGACY DSSS RATES (1TX)</b>	<b>LEGACY OFDM RATES (1TX)</b>	<b>802.11n HT20 RATES/TURBO QAM (3TX)</b>	<b>802.11n HT40 RATES/TURBO QAM (3TX)</b>
1		17.0	17.0	12.0	
2		17.0	17.0	12.0	
3	(1, 5)	17.0	17.0	12.0	12.0
4	(2, 6)	17.0	17.0	12.0	12.0
5	(3, 7)	17.0	17.0	12.0	12.0
6	(4, 8)	17.0	17.0	12.0	12.0
7	(5, 9)	17.0	17.0	12.0	12.0
8	(6, 10)	17.0	17.0	12.0	12.0
9	(7, 11)	17.0	17.0	12.0	12.0
10		17.0	17.0	12.0	12.0
11		17.0	17.0	12.0	12.0
12		17.0	17.0	12.0	
13		17.0	17.0	12.0	
14					

Internal antenna, peak gain = 4.13dBi

## 22.4 EU Regulatory Domain 5 GHz Band

### 22.4.1 External Dipole Antenna Model

The following is a transmit power table (EU domain) per external dipole antenna in the 5 GHz band:

<b>20 MHZ CHANNEL</b>	<b>40 MHZ CHANNEL</b>	<b>80 MHZ CHANNELS</b>	<b>LEGACY OFDM RATES (1TX)</b>	<b>802.11n HT20 RATES (3TX)</b>	<b>802.11n HT40 RATES (3TX)</b>	<b>802.11n HT80 RATES (3TX)</b>
36			20.0	16.0		
38	(36, 40)		20.0	16.0	16.0	
40			20.0	16.0		
42		(36, 40, 44, 48)	20.0	16.0		16.0
44			20.0	16.0		
46	(44, 48)		20.0	16.0	16.0	
48			20.0	16.0		
52			20.0	16.0		
54	(52, 56)		20.0	16.0	16.0	
56			20.0	16.0		
58		(52, 56, 60, 64)	20.0	16.0		16.0
60			20.0	16.0		
62	(60, 64)		20.0	16.0	16.0	
64			20.0	16.0		
100			20.0	20.0		
102	(100, 104)		20.0	20.0	20.0	
104			20.0	20.0		
106		(100, 104, 108, 112)	20.0	20.0		20.0
108			20.0	20.0		
110			20.0	20.0	20.0	
112			20.0	20.0		
114			20.0	20.0		
116			20.0	20.0		
118	(116, 120)		20.0	20.0	20.0	
120			20.0	20.0		
122		(116, 120, 124, 128)	20.0	20.0		20.0
124			20.0	20.0		

<b>20 MHZ CHANNEL</b>	<b>40 MHZ CHANNEL</b>	<b>80 MHZ CHANNELS</b>	<b>LEGACY OFDM RATES (1TX)</b>	<b>802.11n HT20 RATES (3TX)</b>	<b>802.11n HT40 RATES (3TX)</b>	<b>802.11n HT80 RATES (3TX)</b>
126	(124, 128)		20.0	20.0		
128			20.0	20.0		
130			20.0	20.0		
132			20.0	20.0		
134	(132, 136)		20.0	20.0	20.0	
136			20.0	20.0		
138			20.0	20.0		
140			20.0	20.0		
142			20.0	20.0	20.0	
144			20.0	20.0		
149						
151	(149, 153)					
153						
155		(149, 153, 157, 161)				
157						
159	(157, 161)					
161						
165						

External dipole antenna, peak gain = 5dBi

## 22.4.2 External Panel Antenna Model

The following is a transmit power table (EU domain) per external panel antenna in the 5 GHz band:



**NOTE:** The use of this panel antenna requires 1ft cable between the AP and the antenna element. If the antenna gain is 5.1dB or less, the cable is not required.

<b>20 MHZ CHANNEL</b>	<b>40 MHZ CHANNEL</b>	<b>80 MHZ CHANNELS</b>	<b>LEGACY OFDM RATES (1TX)</b>	<b>802.11n HT20 RATES (3TX)</b>	<b>802.11n HT40 RATES (3TX)</b>	<b>802.11n HT80 RATES (3TX)</b>
36			20.0	16.0		
38	(36, 40)		20.0	16.0	16.0	
40			20.0	16.0		
42		(36, 40, 44, 48)	20.0	16.0		16.0
44			20.0	16.0		
46	(44, 48)		20.0	16.0	16.0	
48			20.0	16.0		
52			20.0	16.0		
54	(52, 56)		20.0	16.0	16.0	
56			20.0	16.0		
58		(52, 56, 60, 64)	20.0	16.0		16.0
60			20.0	16.0		
62	(60, 64)		20.0	16.0	16.0	
64			20.0	16.0		
100			20.0	16.0		
102	(100, 104)		20.0	16.0	20.0	
104			20.0	16.0		
106		(100, 104, 108, 112)	20.0	16.0		20.0
108			20.0	16.0		
110			20.0	16.0	20.0	
112			20.0	16.0		
114			20.0	16.0		
116			20.0	16.0		
118	(116, 120)		20.0	16.0	20.0	
120			20.0	16.0		
122		(116, 120, 124, 128)	20.0	16.0		20.0
124			20.0	16.0		

<b>20 MHZ CHANNEL</b>	<b>40 MHZ CHANNEL</b>	<b>80 MHZ CHANNELS</b>	<b>LEGACY OFDM RATES (1TX)</b>	<b>802.11n HT20 RATES (3TX)</b>	<b>802.11n HT40 RATES (3TX)</b>	<b>802.11n HT80 RATES (3TX)</b>
126	(124, 128)		20.0	16.0	20.0	
128			20.0	16.0		
130			20.0	16.0		
132			20.0	16.0		
134	(132, 136)		20.0	16.0	20.0	
136			20.0	16.0		
138			20.0	16.0		
140			20.0	16.0		
142			20.0	16.0	20.0	
144			20.0	16.0		
149						
151	(149, 153)					
153						
155		(149, 153, 157, 161)				
157						
159	(157, 161)					
161						
165						

External panel antenna, peak gain = 6dBi

### 22.4.3 Internal Antenna Model

The following is a transmit power table (EU domain) per internal antenna in the 5 GHz band:

<b>20 MHZ CHANNEL</b>	<b>40 MHZ CHANNEL</b>	<b>80 MHZ CHANNELS</b>	<b>LEGACY OFDM RATES (1TX)</b>	<b>802.11n HT20 RATES (3TX)</b>	<b>802.11n HT40 RATES (3TX)</b>	<b>802.11n HT80 RATES (3TX)</b>
36			20.0	16.0		
38	(36, 40)		20.0	16.0	16.0	
40			20.0	16.0		
42		(36, 40, 44, 48)	20.0	16.0		16.0
44			20.0	16.0		
46	(44, 48)		20.0	16.0	16.0	
48			20.0	16.0		
52			20.0	16.0		
54	(52, 56)		20.0	16.0	16.0	
56			20.0	16.0		
58		(52, 56, 60, 64)	20.0	16.0		16.0
60			20.0	16.0		
62	(60, 64)		20.0	16.0	16.0	
64			20.0	16.0		
100			20.0	20.0		
102	(100, 104)		20.0	20.0	20.0	
104			20.0	20.0		
106		(100, 104, 108, 112)	20.0	20.0		20.0
108			20.0	20.0		
110			20.0	20.0	20.0	
112			20.0	20.0		
114			20.0	20.0		
116			20.0	20.0		
118	(116, 120)		20.0	20.0	20.0	
120			20.0	20.0		
122		(116, 120, 124, 128)	20.0	20.0		20.0
124			20.0	20.0		
126	(124, 128)		20.0	20.0	20.0	
128			20.0	20.0		

<b>20 MHZ CHANNEL</b>	<b>40 MHZ CHANNEL</b>	<b>80 MHZ CHANNELS</b>	<b>LEGACY OFDM RATES (1TX)</b>	<b>802.11n HT20 RATES (3TX)</b>	<b>802.11n HT40 RATES (3TX)</b>	<b>802.11n HT80 RATES (3TX)</b>
130			20.0	20.0		
132			20.0	20.0		
134	(132, 136)		20.0	20.0	20.0	
136			20.0	20.0		
138			20.0	20.0		
140			20.0	20.0		
142			20.0	20.0	20.0	
144			20.0	20.0		
149						
151	(149, 153)					
153						
155		(149, 153, 157, 161)				
157						
159	(157, 161)					
161						
165						

Internal antenna, peak gain = 5.92dBi



## 22.5 Japan Regulatory Domain 2.4 GHz Band

### 22.5.1 External Dipole Antenna Model

The following is a transmit power table (Japan domain) per external dipole antenna in the 2.4 GHz band:

<b>20 MHZ CHANNEL</b>	<b>40 MHZ CHANNEL</b>	<b>LEGACY DSSS RATES (1TX)</b>	<b>LEGACY OFDM RATES (1TX)</b>	<b>802.11n HT20 RATES/TURBO QAM (3TX)</b>	<b>802.11n HT40 RATES/TURBO QAM (3TX)</b>
1		20.0	20.0	18.0	
2		20.0	20.0	18.0	
3	(1, 5)	20.0	20.0	18.0	18.0
4	(2, 6)	20.0	20.0	18.0	18.0
5	(3, 7)	20.0	20.0	18.0	18.0
6	(4, 8)	20.0	20.0	18.0	18.0
7	(5, 9)	20.0	20.0	18.0	18.0
8	(6, 10)	20.0	20.0	18.0	18.0
9	(7, 11)	20.0	20.0	18.0	18.0
10	(8, 12)	20.0	20.0	18.0	18.0
11	(9, 13)	20.0	20.0	18.0	18.0
12		20.0	20.0	18.0	
13		20.0	20.0	18.0	

External dipole antenna, peak gain = 3.17dBi

## 22.5.2 External Panel Antenna Model

The following is a transmit power table (Japan domain) per external panel antenna in the 2.4 GHz band:



**NOTE:** The use of this panel antenna requires 1ft cable between the AP and the antenna element. If the antenna gain is 5.1dB or less, the cable is not required.

<b>20 MHZ CHANNEL</b>	<b>40 MHZ CHANNEL</b>	<b>LEGACY DSSS RATES (1TX)</b>	<b>LEGACY OFDM RATES (1TX)</b>	<b>802.11n HT20 RATES/TURBO QAM (3TX)</b>	<b>802.11n HT40 RATES/TURBO QAM (3TX)</b>
1		16.0	16.0	11.0	
2		16.0	16.0	11.0	
3	(1, 5)	16.0	16.0	11.0	11.0
4	(2, 6)	16.0	16.0	11.0	11.0
5	(3, 7)	16.0	16.0	11.0	11.0
6	(4, 8)	16.0	16.0	11.0	11.0
7	(5, 9)	16.0	16.0	11.0	11.0
8	(6, 10)	16.0	16.0	11.0	11.0
9	(7, 11)	16.0	16.0	11.0	11.0
10	(8, 12)	16.0	16.0	11.0	11.0
11	(9, 13)	16.0	16.0	11.0	11.0
12		16.0	16.0	11.0	
13		16.0	16.0	11.0	

External panel antenna, peak gain = 5.5dBi

### 22.5.3 Internal Antenna Model

The following is a transmit power table (Japan domain) per internal antenna in the 2.4 GHz band:

<b>20 MHZ CHANNEL</b>	<b>40 MHZ CHANNEL</b>	<b>LEGACY DSSS RATES (1TX)</b>	<b>LEGACY OFDM RATES (1TX)</b>	<b>802.11n HT20 RATES/TURBO QAM (3TX)</b>	<b>802.11n HT40 RATES/TURBO QAM (3TX)</b>
1		18.0	20.0	16.0	
2		18.0	20.0	16.0	
3	(1, 5)	18.0	20.0	16.0	16.0
4	(2, 6)	18.0	20.0	16.0	16.0
5	(3, 7)	18.0	20.0	16.0	16.0
6	(4, 8)	18.0	20.0	16.0	16.0
7	(5, 9)	18.0	20.0	16.0	16.0
8	(6, 10)	18.0	20.0	16.0	16.0
9	(7, 11)	18.0	20.0	16.0	16.0
10		18.0	20.0	16.0	16.0
11		18.0	20.0	16.0	16.0
12		18.0	20.0	16.0	
13		18.0	20.0	16.0	

Internal antenna, peak gain = 4.13dBi

## 22.6 Japan Regulatory Domain 5 GHz Band

### 22.6.1 External Dipole Antenna Model

The following is a transmit power table (Japan domain) per external dipole antenna in the 5 GHz band:

<b>20 MHZ CHANNEL</b>	<b>40 MHZ CHANNEL</b>	<b>80 MHZ CHANNELS</b>	<b>LEGACY OFDM RATES (1TX)</b>	<b>802.11n HT20 RATES (3TX)</b>	<b>802.11n HT40 RATES (3TX)</b>	<b>802.11n HT80 RATES (3TX)</b>
36			20.0	16.0		
38	(36, 40)		20.0	16.0	16.0	
40			20.0	16.0		
42		(36, 40, 44, 48)	20.0	16.0		16.0
44			20.0	16.0		
46	(44, 48)		20.0	16.0	16.0	
48			20.0	16.0		
52			20.0	16.0		
54	(52, 56)		20.0	16.0	16.0	
56			20.0	16.0		
58		(52, 56, 60, 64)	20.0	16.0		16.0
60			20.0	16.0		
62	(60, 64)		20.0	16.0	16.0	
64			20.0	16.0		
100			20.0	20.0		
102	(100, 104)		20.0	20.0	20.0	
104			20.0	20.0		
106		(100, 104, 108, 112)	20.0	20.0		20.0
108			20.0	20.0		
110			20.0	20.0	20.0	
112			20.0	20.0		
114			20.0	20.0		
116			20.0	20.0		
118	(116, 120)		20.0	20.0	20.0	
120			20.0	20.0		
122		(116, 120, 124, 128)	20.0	20.0		20.0
124			20.0	20.0		

<b>20 MHZ CHANNEL</b>	<b>40 MHZ CHANNEL</b>	<b>80 MHZ CHANNELS</b>	<b>LEGACY OFDM RATES (1TX)</b>	<b>802.11n HT20 RATES (3TX)</b>	<b>802.11n HT40 RATES (3TX)</b>	<b>802.11n HT80 RATES (3TX)</b>
126	(124, 128)		20.0	20.0		
128			20.0	20.0		
130			20.0	20.0		
132			20.0	20.0		
134	(132, 136)		20.0	20.0	20.0	
136			20.0	20.0		
138			20.0	20.0		
140			20.0	20.0		
142			20.0	20.0	20.0	
144			20.0	20.0		

External dipole antenna, peak gain = 5dBi

## 22.6.2 External Panel Antenna Model

The following is a transmit power table (Japan domain) per external panel antenna in the 5 GHz band:



**NOTE:** The use of this panel antenna requires 1ft cable between the AP and the antenna element. If the antenna gain is 5.1dB or less, the cable is not required.

<b>20 MHZ CHANNEL</b>	<b>40 MHZ CHANNEL</b>	<b>80 MHZ CHANNELS</b>	<b>LEGACY OFDM RATES (1TX)</b>	<b>802.11n HT20 RATES (3TX)</b>	<b>802.11n HT40 RATES (3TX)</b>	<b>802.11n HT80 RATES (3TX)</b>
36			20.0	15.0		
38	(36, 40)		20.0	15.0	15.0	
40			20.0	15.0		
42		(36, 40, 44, 48)	20.0	15.0		15.0
44			20.0	15.0		
46	(44, 48)		20.0	15.0	15.0	
48			20.0	15.0		
52			20.0	15.0		
54	(52, 56)		20.0	15.0	15.0	
56			20.0	15.0		
58		(52, 56, 60, 64)	20.0	15.0		15.0
60			20.0	15.0		
62	(60, 64)		20.0	15.0	15.0	
64			20.0	15.0		
100			20.0	20.0		
102	(100, 104)		20.0	20.0	20.0	
104			20.0	20.0		
106		(100, 104, 108, 112)	20.0	20.0		20.0
108			20.0	20.0		
110			20.0	20.0	20.0	
112			20.0	20.0		
114			20.0	20.0		
116			20.0	20.0		
118	(116, 120)		20.0	20.0	20.0	
120			20.0	20.0		
122		(116, 120, 124, 128)	20.0	20.0		20.0
124			20.0	20.0		

<b>20 MHZ CHANNEL</b>	<b>40 MHZ CHANNEL</b>	<b>80 MHZ CHANNELS</b>	<b>LEGACY OFDM RATES (1TX)</b>	<b>802.11n HT20 RATES (3TX)</b>	<b>802.11n HT40 RATES (3TX)</b>	<b>802.11n HT80 RATES (3TX)</b>
126	(124, 128)		20.0	20.0	20.0	
128			20.0	20.0		
130			20.0	20.0		
132			20.0	20.0		
134	(132, 136)		20.0	20.0	20.0	
136			20.0	20.0		
138			20.0	20.0		
140			20.0	20.0		
142			20.0	20.0	20.0	
144			20.0	20.0		

External panel antenna, peak gain = 6dBi

### 22.6.3 Internal Antenna Model

The following is a transmit power table (Japan domain) per internal antenna in the 5 GHz band:

<b>20 MHZ CHANNEL</b>	<b>40 MHZ CHANNEL</b>	<b>80 MHZ CHANNELS</b>	<b>LEGACY OFDM RATES (1TX)</b>	<b>802.11n HT20 RATES (3TX)</b>	<b>802.11n HT40 RATES (3TX)</b>	<b>802.11n HT80 RATES (3TX)</b>
36			17.0	12.0		
38	(36, 40)		17.0	12.0	12.0	
40			17.0	12.0		
42		(36, 40, 44, 48)	17.0	12.0		12.0
44			17.0	12.0		
46	(44, 48)		17.0	12.0	12.0	
48			17.0	12.0		
52			17.0	12.0		
54	(52, 56)		17.0	12.0	12.0	
56			17.0	12.0		
58		(52, 56, 60, 64)	17.0	12.0		12.0
60			17.0	12.0		
62	(60, 64)		17.0	12.0	12.0	
64			17.0	12.0		
100			20.0	19.0		
102	(100, 104)		20.0	19.0	19.0	
104			20.0	19.0		
106		(100, 104, 108, 112)	20.0	19.0		19.0
108			20.0	19.0		
110			20.0	19.0	19.0	
112			20.0	19.0		
114			20.0	19.0		
116			20.0	19.0		
118	(116, 120)		20.0	19.0	19.0	
120			20.0	19.0		
122		(116, 120, 124, 128)	20.0	19.0		19.0
124			20.0	19.0		
126	(124, 128)		20.0	19.0	19.0	
128			20.0	19.0		



<b>20 MHZ CHANNEL</b>	<b>40 MHZ CHANNEL</b>	<b>80 MHZ CHANNES</b>	<b>LEGACY OFDM RATES (1TX)</b>	<b>802.11n HT20 RATES (3TX)</b>	<b>802.11n HT40 RATES (3TX)</b>	<b>802.11n HT80 RATES (3TX)</b>
130			20.0	19.0		
132			20.0	19.0		
134	(132, 136)		20.0	19.0	19.0	
136			20.0	19.0		
138			20.0	19.0		
140			20.0	19.0		
142			20.0	19.0	19.0	
144			20.0	19.0		

Internal antenna, peak gain = 5.92dBi

## 22.7 NCC Domain

Refer to the following for an AP7532 antenna power table for the NCC domain.

### 22.7.1 2.4 GHz

2412 to 2462 MHz

	ANTENNA GAIN (dBi)	TYPE	MAX CONDUCTED POWER SETTINGS (dBm)
ML-2452-APA2-01	3.17	Dipole	21
ML-2452-HPA5-036	3	Dipole	21
ML-2452-PNA5-01R	4.8	Panel	21

### 22.7.2 5.2 GHz

5250 to 5350 MHz

	ANTENNA GAIN (dBi)	TYPE	MAX CONDUCTED POWER SETTINGS (dBm)
ML-2452-APA2-01	4.85	Dipole	13
ML-2452-HPA5-036	5	Dipole	13
ML-2452-PNA5-01R	5.1	Panel	13

5470 to 5725 MHz

	ANTENNA GAIN (dBi)	TYPE	MAX CONDUCTED POWER SETTINGS (dBm)
ML-2452-APA2-01	4.85	Dipole	20
ML-2452-HPA5-036	5	Dipole	20
ML-2452-PNA5-01R	5.1	Panel	20

5725 to 5850 MHz

	ANTENNA GAIN (dBi)	TYPE	MAX CONDUCTED POWER SETTINGS (dBm)
ML-2452-APA2-01	4.85	Dipole	20
ML-2452-HPA5-036	5	Dipole	20
ML-2452-PNA5-01R	5.1	Panel	20

## ***AP7522 Regulatory Domains***

### **23.1 US Regulatory Domain 2.4 GHz Band**

#### ***23.1.1 External Dipole Antenna Maximum Conducted Transmit Power Settings***

The following is a transmit power table (US domain) per external dipole antenna in the 2.4 GHz band:

<b><i>20 MHZ CHANNEL</i></b>	<b><i>40 MHZ CHANNEL</i></b>	<b><i>LEGACY DSSS RATES (1TX)</i></b>	<b><i>LEGACY OFDM RATES (1TX)</i></b>	<b><i>802.11n HT20 RATES/TURBO QAM (2TX)</i></b>	<b><i>802.11n HT40 RATES/TURBO QAM (2TX)</i></b>
1		20.0	16.0	16.0	
2		20.0	20.0	20.0	
3	(1, 5)	20.0	20.0	20.0	14.0
4	(2, 6)	20.0	20.0	20.0	15.0
5	(3, 7)	20.0	20.0	20.0	15.0
6	(4, 8)	20.0	20.0	20.0	15.0
7	(5, 9)	20.0	20.0	20.0	15.0
8	(6, 10)	20.0	20.0	20.0	15.0
9	(7, 11)	20.0	20.0	20.0	15.0
10		20.0	20.0	20.0	
11		20.0	16.0	16.0	

External dipole antenna, peak gain = 3.17dBi

### 23.1.2 External Panel Antenna Maximum Conducted Transmit Power Settings

The following is a transmit power table (US domain) per external panel antenna in the 2.4 GHz band:



**NOTE:** The use of this panel antenna requires 1ft cable between the AP and the antenna element. If the antenna gain is 4.8 dB or less, the cable is not required.

<b>20 MHZ CHANNEL</b>	<b>40 MHZ CHANNEL</b>	<b>LEGACY DSSS RATES (1TX)</b>	<b>LEGACY OFDM RATES (1TX)</b>	<b>802.11n HT20 RATES/TURBO QAM (2TX)</b>	<b>802.11n HT40 RATES/TURBO QAM (2TX)</b>
1		20.0	15.0	15.0	
2		20.0	20.0	20.0	
3	(1, 5)	20.0	20.0	20.0	13.0
4	(2, 6)	20.0	20.0	20.0	16.0
5	(3, 7)	20.0	20.0	20.0	16.0
6	(4, 8)	20.0	20.0	20.0	16.0
7	(5, 9)	20.0	20.0	20.0	16.0
8	(6, 10)	20.0	20.0	20.0	16.0
9	(7, 11)	20.0	20.0	20.0	16.0
10		20.0	20.0	20.0	
11		20.0	16.0	16.0	

External panel antenna, peak gain = 5.5dBi

### 23.1.3 Internal Antenna Maximum Conducted Transmit Power Settings

The following is a transmit power table (US domain) per internal antenna in the 2.4 GHz band:

<b>20 MHZ CHANNEL</b>	<b>40 MHZ CHANNEL</b>	<b>LEGACY DSSS RATES (1TX)</b>	<b>LEGACY OFDM RATES (1TX)</b>	<b>802.11n HT20 RATES/TURBO QAM (2TX)</b>	<b>802.11n HT40 RATES/TURBO QAM (2TX)</b>
1		20.0	15.0	15.0	
2		20.0	20.0	20.0	
3	(1, 5)	20.0	20.0	20.0	14.0
4	(2, 6)	20.0	20.0	20.0	15.0
5	(3, 7)	20.0	20.0	20.0	15.0
6	(4, 8)	20.0	20.0	20.0	15.0
7	(5, 9)	20.0	20.0	20.0	15.0
8	(6, 10)	20.0	20.0	20.0	15.0
9	(7, 11)	20.0	20.0	20.0	15.0
10		20.0	20.0	20.0	
11		20.0	17.0	15.0	

Internal antenna, peak gain = 4.13dBi

## 23.2 US Regulatory Domain 5 GHz Band

### 23.2.1 External Dipole Antenna Model

The following is a transmit power table (US domain) per external dipole antenna in the 5 GHz band:

<b>20 MHZ CHANNEL</b>	<b>40 MHZ CHANNEL</b>	<b>80 MHZ CHANNELS</b>	<b>LEGACY OFDM RATES (1TX)</b>	<b>802.11n HT20 RATES (2TX)</b>	<b>802.11n HT40 RATES (2TX)</b>	<b>802.11n HT80 RATES (2TX)</b>
36			19.0	18.0		
38	(36, 40)		20.0	19.0	15.0	
40			20.0	19.0		
42		(36, 40, 44, 48)	20.0	19.0		14.0
44			20.0	19.0		
46	(44, 48)		20.0	19.0	20.0	
48			20.0	19.0		
52			19.0	20.0		
54	(52, 56)		19.0	20.0	20.0	
56			20.0	20.0		
58		(52, 56, 60, 64)	20.0	20.0		13.0
60			20.0	20.0		
62	(60, 64)		20.0	20.0	20.0	
64			19.0	19.0		
100			18.0	18.0		
102	(100, 104)		20.0	20.0	15.0	
104			20.0	20.0		
106		(100, 104, 108, 112)	20.0	20.0		15.0
108			20.0	20.0		
110			20.0	20.0	20.0	
112			20.0	20.0		
114			20.0	20.0		
116			20.0	20.0		
118	(116, 120)		20.0	20.0	20.0	
120			20.0	20.0		
122		(116, 120, 124, 128)	20.0	20.0		21.0
124			20.0	20.0		

<b>20 MHZ CHANNEL</b>	<b>40 MHZ CHANNEL</b>	<b>80 MHZ CHANNELS</b>	<b>LEGACY OFDM RATES (1TX)</b>	<b>802.11n HT20 RATES (2TX)</b>	<b>802.11n HT40 RATES (2TX)</b>	<b>802.11n HT80 RATES (2TX)</b>
126	(124, 128)		20.0	20.0	20.0	
128			20.0	20.0		
130			20.0	20.0		
132			20.0	20.0		
134	(132, 136)		20.0	20.0	18.0	
136			20.0	20.0		
138			20.0	20.0		
140			16.0	16.0		
142			16.0	16.0	20.0	
144			20.0	20.0		
149			16.0	15.0		
151	(149, 153)		20.0	17.0	13.0	
153			20.0	17.0		
155		(149, 153, 157, 161)	20.0	17.0		10.0
157			20.0	17.0		
159	(157, 161)		20.0	17.0	15.0	
161			20.0	17.0		
165			17.0	17.0		

External dipole antenna, peak gain = 5dBi

## 23.2.2 External Panel Antenna Model

The following is a transmit power table (US domain) per external panel antenna in the 5 GHz band:



**NOTE:** The use of this panel antenna requires 1ft cable between the AP and the antenna element. If the antenna gain is 4.8 dB or less, the cable is not required.

<b>20 MHZ CHANNEL</b>	<b>40 MHZ CHANNEL</b>	<b>80 MHZ CHANNELS</b>	<b>LEGACY OFDM RATES (1TX)</b>	<b>802.11n HT20 RATES (2TX)</b>	<b>802.11n HT40 RATES (2TX)</b>	<b>802.11n HT80 RATES (2TX)</b>
36			19.0	18.0		
38	(36, 40)		20.0	19.0	15.0	
40			20.0	19.0		
42		(36, 40, 44, 48)	20.0	19.0		14.0
44			20.0	19.0		
46	(44, 48)		20.0	19.0	20.0	
48			20.0	19.0		
52			19.0	20.0		
54	(52, 56)		19.0	20.0	20.0	
56			20.0	20.0		
58		(52, 56, 60, 64)	20.0	20.0		13.0
60			20.0	20.0		
62	(60, 64)		20.0	20.0	20.0	
64			19.0	19.0		
100			18.0	18.0		
102	(100, 104)		20.0	20.0	16.0	
104			20.0	20.0		
106		(100, 104, 108, 112)	20.0	20.0		16.0
108			20.0	20.0		
110			20.0	20.0	19.0	
112			20.0	20.0		
114			20.0	20.0		
116			20.0	20.0		
118	(116, 120)		20.0	20.0	19.0	
120			20.0	20.0		
122		(116, 120, 124, 128)	20.0	20.0		20.0
124			20.0	20.0		



<b>20 MHZ CHANNEL</b>	<b>40 MHZ CHANNEL</b>	<b>80 MHZ CHANNELS</b>	<b>LEGACY OFDM RATES (1TX)</b>	<b>802.11n HT20 RATES (2TX)</b>	<b>802.11n HT40 RATES (2TX)</b>	<b>802.11n HT80 RATES (2TX)</b>
126	(124, 128)		20.0	20.0	19.0	
128			20.0	20.0		
130			20.0	20.0		
132			20.0	20.0		
134	(132, 136)		20.0	20.0	18.0	
136			20.0	20.0		
138			20.0	20.0		
140			16.0	16.0		
142			16.0	16.0	20.0	
144			20.0	20.0		
149			16.0	15.0		
151	(149, 153)		20.0	17.0	13.0	
153			20.0	17.0		
155		(149, 153, 157, 161)	20.0	17.0		10.0
157			20.0	17.0		
159	(157, 161)		20.0	17.0	15.0	
161			20.0	17.0		
165			17.0	17.0		

External panel antenna, peak gain = 6dBi

### 23.2.3 Internal Antenna Model

The following is a transmit power table (US domain) per internal antenna in the 5 GHz band:

<b>20 MHZ CHANNEL</b>	<b>40 MHZ CHANNEL</b>	<b>80 MHZ CHANNELS</b>	<b>LEGACY OFDM RATES (1TX)</b>	<b>802.11n HT20 RATES (2TX)</b>	<b>802.11n HT40 RATES (2TX)</b>	<b>802.11n HT80 RATES (2TX)</b>
36			19.0	18.0		
38	(36, 40)		20.0	19.0	15.0	
40			20.0	19.0		
42		(36, 40, 44, 48)	20.0	19.0		14.0
44			20.0	19.0		
46	(44, 48)		20.0	19.0	20.0	
48			20.0	19.0		
52			20.0	17.0		
54	(52, 56)		20.0	17.0	20.0	
56			20.0	17.0		
58		(52, 56, 60, 64)	20.0	17.0		13.0
60			20.0	17.0		
62	(60, 64)		20.0	17.0	20.0	
64			18.0	17.0		
100			20.0	17.0		
102	(100, 104)		20.0	17.0	13.0	
104			20.0	17.0		
106		(100, 104, 108, 112)	20.0	17.0		14.0
108			20.0	17.0		
110			20.0	17.0	18.0	
112			20.0	17.0		
114			20.0	17.0		
116			20.0	17.0		
118	(116, 120)		20.0	17.0	18.0	
120			20.0	17.0		
122		(116, 120, 124, 128)	20.0	17.0		19.0
124			20.0	17.0		
126	(124, 128)		20.0	17.0	18.0	
128			20.0	17.0		
130			20.0	17.0		
132			20.0	17.0		

<b>20 MHZ CHANNEL</b>	<b>40 MHZ CHANNEL</b>	<b>80 MHZ CHANNELS</b>	<b>LEGACY OFDM RATES (1TX)</b>	<b>802.11n HT20 RATES (2TX)</b>	<b>802.11n HT40 RATES (2TX)</b>	<b>802.11n HT80 RATES (2TX)</b>
134	(132, 136)		20.0	17.0	17.0	
136			20.0	17.0		
138			20.0	17.0		
140			16.0	16.0		
142			16.0	16.0	18.0	
144			20.0	18.0		
149			16.0	15.0		
151	(149, 153)		20.0	17.0	13.0	
153			20.0	17.0		
155		(149, 153, 157, 161)	20.0	17.0		10.0
157			20.0	17.0		
159	(157, 161)		20.0	17.0	15.0	
161			20.0	17.0		
165			17.0	17.0		

Internal antenna, peak gain = 5.92dBi

## 23.3 EU Regulatory Domain 2.4 GHz Band

### 23.3.1 External Dipole Antenna Maximum Conducted Transmit Power Settings

The following is a transmit power table (EU domain) per external dipole antenna in the 2.4 GHz band:

<b>20 MHZ CHANNEL</b>	<b>40 MHZ CHANNEL</b>	<b>LEGACY DSSS RATES (1TX)</b>	<b>LEGACY OFDM RATES (1TX)</b>	<b>802.11n HT20 RATES/TURBO QAM (2TX)</b>	<b>802.11n HT40 RATES/TURBO QAM (2TX)</b>
1		18.0	18.0	15.0	
2		18.0	18.0	15.0	
3	(1, 5)	18.0	18.0	15.0	15.0
4	(2, 6)	18.0	18.0	15.0	15.0
5	(3, 7)	18.0	18.0	15.0	15.0
6	(4, 8)	18.0	18.0	15.0	15.0
7	(5, 9)	18.0	18.0	15.0	15.0
8	(6, 10)	18.0	18.0	15.0	15.0
9	(7, 11)	18.0	18.0	15.0	15.0
10		18.0	18.0	15.0	15.0
11		18.0	18.0	15.0	15.0
12		18.0	18.0	15.0	15.0
13		18.0	18.0	15.0	
14					

Dipole antenna, peak gain = 3.17dBi

### 23.3.2 External Panel Antenna Maximum Conducted Transmit Power Settings

The following is a transmit power table (EU domain) per external panel antenna in the 2.4 GHz band:



**NOTE:** The use of this panel antenna requires 1ft cable between the AP and the antenna element. If the antenna gain is 5.1 dB or less, the cable is not required.

<b>20 MHZ CHANNEL</b>	<b>40 MHZ CHANNEL</b>	<b>LEGACY DSSS RATES (1TX)</b>	<b>LEGACY OFDM RATES (1TX)</b>	<b>802.11n HT20 RATES/TURBO QAM (2TX)</b>	<b>802.11n HT40 RATES/TURBO QAM (2TX)</b>
1		16.0	16.0	13.0	
2		16.0	16.0	13.0	
3	(1, 5)	16.0	16.0	13.0	13.0
4	(2, 6)	16.0	16.0	13.0	13.0
5	(3, 7)	16.0	16.0	13.0	13.0
6	(4, 8)	16.0	16.0	13.0	13.0
7	(5, 9)	16.0	16.0	13.0	13.0
8	(6, 10)	16.0	16.0	13.0	13.0
9	(7, 11)	16.0	16.0	13.0	13.0
10		16.0	16.0	13.0	13.0
11		16.0	16.0	13.0	13.0
12		16.0	16.0	13.0	13.0
13		16.0	16.0	13.0	
14					

Panel antenna, peak gain = 5.5dBi

### 23.3.3 Internal Antenna Maximum Conducted Transmit Power Settings

The following is a transmit power table (EU domain) per internal antenna in the 2.4 GHz band:

<b>20 MHZ CHANNEL</b>	<b>40 MHZ CHANNEL</b>	<b>LEGACY DSSS RATES (1TX)</b>	<b>LEGACY OFDM RATES (1TX)</b>	<b>802.11n HT20 RATES/TURBO QAM (2TX)</b>	<b>802.11n HT40 RATES/TURBO QAM (2TX)</b>
1		17.0	17.0	14.0	
2		17.0	17.0	14.0	
3	(1, 5)	17.0	17.0	14.0	14.0
4	(2, 6)	17.0	17.0	14.0	14.0
5	(3, 7)	17.0	17.0	14.0	14.0
6	(4, 8)	17.0	17.0	14.0	14.0
7	(5, 9)	17.0	17.0	14.0	14.0
8	(6, 10)	17.0	17.0	14.0	14.0
9	(7, 11)	17.0	17.0	14.0	14.0
10		17.0	17.0	14.0	14.0
11		17.0	17.0	14.0	14.0
12		17.0	17.0	14.0	14.0
13		17.0	17.0	14.0	
14					

Internal antenna, peak gain = 4.13dBi

## 23.4 EU Regulatory Domain 5 GHz Band

### 23.4.1 External Dipole Antenna Model

The following is a transmit power table (EU domain) per external dipole antenna in the 5 GHz band:

<b>20 MHZ CHANNEL</b>	<b>40 MHZ CHANNEL</b>	<b>80 MHZ CHANNELS</b>	<b>LEGACY OFDM RATES (1TX)</b>	<b>802.11n HT20 RATES (2TX)</b>	<b>802.11n HT40 RATES (2TX)</b>	<b>802.11n HT80 RATES (2TX)</b>
36			20.0	18.0		
38	(36, 40)		20.0	18.0	18.0	
40			20.0	18.0		
42		(36, 40, 44, 48)	20.0	18.0		18.0
44			20.0	18.0		
46	(44, 48)		20.0	18.0	18.0	
48			20.0	18.0		
52			20.0	18.0		
54	(52, 56)		20.0	18.0	18.0	
56			20.0	18.0		
58		(52, 56, 60, 64)	20.0	18.0		18.0
60			20.0	18.0		
62	(60, 64)		20.0	18.0	18.0	
64			20.0	18.0		
100			20.0	20.0		
102	(100, 104)		20.0	20.0	20.0	
104			20.0	20.0		
106		(100, 104, 108, 112)	20.0	20.0		20.0
108			20.0	20.0		
110			20.0	20.0		
112			20.0	20.0		
114			20.0	20.0		
116			20.0	20.0		
118	(116, 120)		20.0	20.0	20.0	
120			20.0	20.0		
122		(116, 120, 124, 128)	20.0	20.0		20.0
124			20.0	17.0		

<b>20 MHZ CHANNEL</b>	<b>40 MHZ CHANNEL</b>	<b>80 MHZ CHANNELS</b>	<b>LEGACY OFDM RATES (1TX)</b>	<b>802.11n HT20 RATES (2TX)</b>	<b>802.11n HT40 RATES (2TX)</b>	<b>802.11n HT80 RATES (2TX)</b>
126	(124, 128)		20.0	20.0	20.0	
128			20.0	20.0		
130			20.0	20.0		
132			20.0	20.0		
134	(132, 136)		20.0	20.0	20.0	
136			20.0	20.0		
138			20.0	20.0		
140			20.0	20.0		
142			20.0	20.0	20.0	
144			20.0	20.0		
149						
151	(149, 153)					
153						
155		(149, 153, 157, 161)				
157						
159	(157, 161)					
161						
165						

External dipole antenna, peak gain = 5dBi



### 23.4.2 External Panel Antenna Model

The following is a transmit power table (EU domain) per external panel antenna in the 5 GHz band:



**NOTE:** The use of this panel antenna requires 1ft cable between the AP and the antenna element. If the antenna gain is 5.1 dB or less, the cable is not required.

<b>20 MHZ CHANNEL</b>	<b>40 MHZ CHANNEL</b>	<b>80 MHZ CHANNELS</b>	<b>LEGACY OFDM RATES (1TX)</b>	<b>802.11n HT20 RATES (2TX)</b>	<b>802.11n HT40 RATES (2TX)</b>	<b>802.11n HT80 RATES (2TX)</b>
36			20.0	17.0		
38	(36, 40)		20.0	17.0	17.0	
40			20.0	17.0		
42		(36, 40, 44, 48)	20.0	17.0		17.0
44			20.0	17.0		
46	(44, 48)		20.0	17.0	17.0	
48			20.0	17.0		
52			20.0	17.0		
54	(52, 56)		20.0	17.0	17.0	
56			20.0	17.0		
58		(52, 56, 60, 64)	20.0	17.0		17.0
60			20.0	17.0		
62	(60, 64)		20.0	17.0	17.0	
64			20.0	17.0		
100			20.0	20.0		
102	(100, 104)		20.0	20.0	20.0	
104			20.0	20.0		
106		(100, 104, 108, 112)	20.0	20.0		20.0
108			20.0	20.0		
110			20.0	20.0		
112			20.0	20.0		
114			20.0	20.0		
116			20.0	20.0		
118	(116, 120)		20.0	20.0	20.0	
120			20.0	20.0		
122		(116, 120, 124, 128)	20.0	20.0		20.0
124			20.0	20.0		

<b>20 MHZ CHANNEL</b>	<b>40 MHZ CHANNEL</b>	<b>80 MHZ CHANNELS</b>	<b>LEGACY OFDM RATES (1TX)</b>	<b>802.11n HT20 RATES (2TX)</b>	<b>802.11n HT40 RATES (2TX)</b>	<b>802.11n HT80 RATES (2TX)</b>
126	(124, 128)		20.0	20.0	20.0	
128			20.0	20.0		
130			20.0	20.0		
132			20.0	20.0		
134	(132, 136)		20.0	20.0	20.0	
136			20.0	20.0		
138			20.0	20.0		
140			20.0	20.0		
142			20.0	20.0	20.0	
144			20.0	20.0		
149						
151	(149, 153)					
153						
155		(149, 153, 157, 161)				
157						
159	(157, 161)					
161						
165						

External dipole antenna, peak gain = 6dBi

### 23.4.3 Internal Antenna Model

The following is a transmit power table (EU domain) per internal antenna in the 5 GHz band:

<b>20 MHZ CHANNEL</b>	<b>40 MHZ CHANNEL</b>	<b>80 MHZ CHANNELS</b>	<b>LEGACY OFDM RATES (1TX)</b>	<b>802.11n HT20 RATES (2TX)</b>	<b>802.11n HT40 RATES (2TX)</b>	<b>802.11n HT80 RATES (2TX)</b>
36			20.0	18.0		
38	(36, 40)		20.0	18.0	18.0	
40			20.0	18.0		
42		(36, 40, 44, 48)	20.0	18.0		18.0
44			20.0	18.0		
46	(44, 48)		20.0	18.0	18.0	
48			20.0	18.0		
52			20.0	18.0		
54	(52, 56)		20.0	18.0	18.0	
56			20.0	18.0		
58		(52, 56, 60, 64)	20.0	18.0		18.0
60			20.0	18.0		
62	(60, 64)		20.0	18.0	18.0	
64			20.0	18.0		
100			20.0	20.0		
102	(100, 104)		20.0	20.0	20.0	
104			20.0	20.0		
106		(100, 104, 108, 112)	20.0	20.0		20.0
108			20.0	20.0		
110			20.0	20.0		
112			20.0	20.0		
114			20.0	20.0		
116			20.0	20.0		
118	(116, 120)		20.0	20.0	20.0	
120			20.0	20.0		
122		(116, 120, 124, 128)	20.0	20.0		20.0
124			20.0	20.0		
126	(124, 128)		20.0	20.0	20.0	
128			20.0	20.0		

<b>20 MHZ CHANNEL</b>	<b>40 MHZ CHANNEL</b>	<b>80 MHZ CHANNELS</b>	<b>LEGACY OFDM RATES (1TX)</b>	<b>802.11n HT20 RATES (2TX)</b>	<b>802.11n HT40 RATES (2TX)</b>	<b>802.11n HT80 RATES (2TX)</b>
130			20.0	20.0		
132			20.0	20.0		
134	(132, 136)		20.0	20.0	20.0	
136			20.0	20.0		
138			20.0	20.0		
140			20.0	20.0		
142			20.0	20.0	20.0	
144			20.0	20.0		
149						
151	(149, 153)					
153						
155		(149, 153, 157, 161)				
157						
159	(157, 161)					
161						
165						

Internal antenna, peak gain = 5.92dBi

## 23.5 Japan Regulatory Domain 2.4 GHz Band

### 23.5.1 External Dipole Antenna Maximum Conducted Transmit Power Settings

The following is a transmit power table (Japan domain) per external dipole antenna in the 2.4 GHz band:

<b>20 MHZ CHANNEL</b>	<b>40 MHZ CHANNEL</b>	<b>LEGACY DSSS RATES (1TX)</b>	<b>LEGACY OFDM RATES (1TX)</b>	<b>802.11n HT20 RATES/TURBO QAM (2TX)</b>	<b>802.11n HT40 RATES/TURBO QAM (2TX)</b>
1		20.0	20.0	20.0	
2		20.0	20.0	20.0	
3	(1, 5)	20.0	20.0	20.0	20.0
4	(2, 6)	20.0	20.0	20.0	20.0
5	(3, 7)	20.0	20.0	20.0	20.0
6	(4, 8)	20.0	20.0	20.0	20.0
7	(5, 9)	20.0	20.0	20.0	20.0
8	(6, 10)	20.0	20.0	20.0	20.0
9	(7, 11)	20.0	20.0	20.0	20.0
10		20.0	20.0	20.0	20.0
11		20.0	20.0	20.0	20.0
12		20.0	20.0	20.0	
13		20.0	20.0	20.0	

Dipole antenna, peak gain = 3.17dBi

### 23.5.2 External Panel Antenna Maximum Conducted Transmit Power Settings

The following is a transmit power table (Japan domain) per external panel antenna in the 2.4 GHz band:



**NOTE:** The use of this panel antenna requires 1ft cable between the AP and the antenna element. If the antenna gain is 5.1 dB or less, the cable is not required.

<b>20 MHZ CHANNEL</b>	<b>40 MHZ CHANNEL</b>	<b>LEGACY DSSS RATES (1TX)</b>	<b>LEGACY OFDM RATES (1TX)</b>	<b>802.11n HT20 RATES/TURBO QAM (2TX)</b>	<b>802.11n HT40 RATES/TURBO QAM (2TX)</b>
1		20.0	20.0	20.0	
2		20.0	20.0	20.0	
3	(1, 5)	20.0	20.0	20.0	20.0
4	(2, 6)	20.0	20.0	20.0	20.0
5	(3, 7)	20.0	20.0	20.0	20.0
6	(4, 8)	20.0	20.0	20.0	20.0
7	(5, 9)	20.0	20.0	20.0	20.0
8	(6, 10)	20.0	20.0	20.0	20.0
9	(7, 11)	20.0	20.0	20.0	20.0
10		20.0	20.0	20.0	20.0
11		20.0	20.0	20.0	20.0
12		20.0	20.0	20.0	
13		20.0	20.0	20.0	

Panel antenna, peak gain = 5.5dBi

### 23.5.3 Internal Antenna Maximum Conducted Transmit Power Settings

The following is a transmit power table (Japan domain) per internal antenna in the 2.4 GHz band:

<b>20 MHZ CHANNEL</b>	<b>40 MHZ CHANNEL</b>	<b>LEGACY DSSS RATES (1TX)</b>	<b>LEGACY OFDM RATES (1TX)</b>	<b>802.11n HT20 RATES/TURBO QAM (2TX)</b>	<b>802.11n HT40 RATES/TURBO QAM (2TX)</b>
1		18.0	20.0	18.0	
2		18.0	20.0	18.0	
3	(1, 5)	18.0	20.0	18.0	18.0
4	(2, 6)	18.0	20.0	18.0	18.0
5	(3, 7)	18.0	20.0	18.0	18.0
6	(4, 8)	18.0	20.0	18.0	18.0
7	(5, 9)	18.0	20.0	18.0	18.0
8	(6, 10)	18.0	20.0	18.0	18.0
9	(7, 11)	18.0	20.0	18.0	18.0
10		18.0	20.0	18.0	18.0
11		18.0	20.0	18.0	18.0
12		18.0	20.0	18.0	
13		18.0	20.0	18.0	

Internal antenna, peak gain = 4.13dBi

## 23.6 Japan Regulatory Domain 5 GHz Band

### 23.6.1 External Dipole Antenna Model

The following is a transmit power table (Japan domain) per external dipole antenna in the 5 GHz band:

<b>20 MHZ CHANNEL</b>	<b>40 MHZ CHANNEL</b>	<b>80 MHZ CHANNELS</b>	<b>LEGACY OFDM RATES (1TX)</b>	<b>802.11n HT20 RATES (2TX)</b>	<b>802.11n HT40 RATES (2TX)</b>	<b>802.11n HT80 RATES (2TX)</b>
36			20.0	18.0		
38	(36, 40)		20.0	18.0	18.0	
40			20.0	18.0		
42		(36, 40, 44, 48)	20.0	18.0		18.0
44			20.0	18.0		
46	(44, 48)		20.0	18.0	18.0	
48			20.0	18.0		
52			20.0	18.0		
54	(52, 56)		20.0	18.0	18.0	
56			20.0	18.0		
58		(52, 56, 60, 64)	20.0	18.0		18.0
60			20.0	18.0		
62	(60, 64)		20.0	18.0	18.0	
64			20.0	18.0		
100			20.0	20.0		
102	(100, 104)		20.0	18.0	20.0	
104			20.0	20.0		
106		(100, 104, 108, 112)	20.0	20.0		20.0
108			20.0	20.0		
110			20.0	20.0		
112			20.0	20.0		
114			20.0	20.0		
116			20.0	20.0		
118	(116, 120)		20.0	20.0	20.0	
120			20.0	20.0		
122		(116, 120, 124, 128)	20.0	20.0		20.0
124			20.0	20.0		



<b>20 MHZ CHANNEL</b>	<b>40 MHZ CHANNEL</b>	<b>80 MHZ CHANNELS</b>	<b>LEGACY OFDM RATES (1TX)</b>	<b>802.11n HT20 RATES (2TX)</b>	<b>802.11n HT40 RATES (2TX)</b>	<b>802.11n HT80 RATES (2TX)</b>
126	(124, 128)		20.0	20.0	20.0	
128			20.0	20.0		
130			20.0	20.0		
132			20.0	20.0		
134	(132, 136)		20.0	20.0	20.0	
136			20.0	20.0		
138			20.0	20.0		
140			20.0	20.0		
142			20.0	20.0	20.0	
144			20.0	20.0		

External dipole antenna, peak gain = 5dBi

## 23.6.2 External Panel Antenna Model

The following is a transmit power table (Japan domain) per external panel antenna in the 5 GHz band:



**NOTE:** The use of this panel antenna requires 1ft cable between the AP and the antenna element. If the antenna gain is 5.1 dB or less, the cable is not required.

<b>20 MHZ CHANNEL</b>	<b>40 MHZ CHANNEL</b>	<b>80 MHZ CHANNELS</b>	<b>LEGACY OFDM RATES (1TX)</b>	<b>802.11n HT20 RATES (2TX)</b>	<b>802.11n HT40 RATES (2TX)</b>	<b>802.11n HT80 RATES (2TX)</b>
36			20.0	17.0		
38	(36, 40)		20.0	17.0	17.0	
40			20.0	17.0		
42		(36, 40, 44, 48)	20.0	17.0		17.0
44			20.0	17.0		
46	(44, 48)		20.0	17.0	17.0	
48			20.0	17.0		
52			20.0	17.0		
54	(52, 56)		20.0	17.0	17.0	
56			20.0	17.0		
58		(52, 56, 60, 64)	20.0	17.0		17.0
60			20.0	17.0		
62	(60, 64)		20.0	17.0	17.0	
64			20.0	17.0		
100			20.0	20.0		
102	(100, 104)		20.0	17.0	20.0	
104			20.0	20.0		
106		(100, 104, 108, 112)	20.0	20.0		20.0
108			20.0	20.0		
110			20.0	20.0		
112			20.0	20.0		
114			20.0	20.0		
116			20.0	20.0		
118	(116, 120)		20.0	20.0	20.0	
120			20.0	20.0		
122		(116, 120, 124, 128)	20.0	20.0		20.0
124			20.0	20.0		

<b>20 MHZ CHANNEL</b>	<b>40 MHZ CHANNEL</b>	<b>80 MHZ CHANNELS</b>	<b>LEGACY OFDM RATES (1TX)</b>	<b>802.11n HT20 RATES (2TX)</b>	<b>802.11n HT40 RATES (2TX)</b>	<b>802.11n HT80 RATES (2TX)</b>
126	(124, 128)		20.0	20.0	20.0	
128			20.0	20.0		
130			20.0	20.0		
132			20.0	20.0		
134	(132, 136)		20.0	20.0	20.0	
136			20.0	20.0		
138			20.0	20.0		
140			20.0	20.0		
142			20.0	20.0	20.0	
144			20.0	20.0		

External dipole antenna, peak gain = 6dBi

### 23.6.3 Internal Antenna Model

The following is a transmit power table (Japan domain) per internal antenna in the 5 GHz band:

<b>20 MHZ CHANNEL</b>	<b>40 MHZ CHANNEL</b>	<b>80 MHZ CHANNELS</b>	<b>LEGACY OFDM RATES (1TX)</b>	<b>802.11n HT20 RATES (2TX)</b>	<b>802.11n HT40 RATES (2TX)</b>	<b>802.11n HT80 RATES (2TX)</b>
36			17.0	14.0		
38	(36, 40)		17.0	14.0	14.0	
40			17.0	14.0		
42		(36, 40, 44, 48)	17.0	14.0		14.0
44			17.0	14.0		
46	(44, 48)		17.0	14.0	14.0	
48			17.0	14.0		
52			17.0	14.0		
54	(52, 56)		17.0	14.0	14.0	
56			17.0	14.0		
58		(52, 56, 60, 64)	17.0	14.0		14.0
60			17.0	14.0		
62	(60, 64)		17.0	14.0	14.0	
64			17.0	14.0		
100			20.0	20.0		
102	(100, 104)		17.0	14.0	20.0	
104			20.0	20.0		
106		(100, 104, 108, 112)	20.0	20.0		20.0
108			20.0	20.0		
110			20.0	20.0		
112			20.0	20.0		
114			20.0	20.0		
116			20.0	20.0		
118	(116, 120)		20.0	20.0	20.0	
120			20.0	20.0		
122		(116, 120, 124, 128)	20.0	20.0		20.0
124			20.0	20.0		
126	(124, 128)		20.0	20.0	20.0	
128			20.0	20.0		

<b>20 MHZ CHANNEL</b>	<b>40 MHZ CHANNEL</b>	<b>80 MHZ CHANNELS</b>	<b>LEGACY OFDM RATES (1TX)</b>	<b>802.11n HT20 RATES (2TX)</b>	<b>802.11n HT40 RATES (2TX)</b>	<b>802.11n HT80 RATES (2TX)</b>
130			20.0	20.0		
132			20.0	20.0		
134	(132, 136)		20.0	20.0	20.0	
136			20.0	20.0		
138			20.0	20.0		
140			20.0	20.0		
142			20.0	20.0	20.0	
144			20.0	20.0		

Internal antenna, peak gain = 5.92dBi

## 23.7 NCC Domain

Refer to the following for an AP7522 antenna power table for the NCC domain.

### 23.7.1 2.4 GHz

2412 to 2462 MHz

	ANTENNA GAIN (dBi)	TYPE	MAX CONDUCTED POWER SETTINGS (dBm)
ML-2452-APA2-01	3.17	Dipole	21
ML-2452-HPA5-036	3	Dipole	21
ML-2452-PNA5-01R	4.8	Panel	21

### 23.7.2 5.2 GHz

5250 to 5350 MHz

	ANTENNA GAIN (dBi)	TYPE	MAX CONDUCTED POWER SETTINGS (dBm)
ML-2452-APA2-01	4.85	Dipole	15
ML-2452-HPA5-036	5	Dipole	15
ML-2452-PNA5-01R	5.1	Panel	15

5470 to 5725 MHz

	ANTENNA GAIN (dBi)	TYPE	MAX CONDUCTED POWER SETTINGS (dBm)
ML-2452-APA2-01	4.85	Dipole	20
ML-2452-HPA5-036	5	Dipole	20
ML-2452-PNA5-01R	5.1	Panel	20

5725 to 5850 MHz

	ANTENNA GAIN (dBi)	TYPE	MAX CONDUCTED POWER SETTINGS (dBm)
ML-2452-APA2-01	4.85	Dipole	21
ML-2452-HPA5-036	5	Dipole	21
ML-2452-PNA5-01R	5.1	Panel	21

## ***AP7502 Regulatory Domains***

### **24.1 US Regulatory Domain 2.4 GHz Band**

#### ***24.1.1 Internal Antenna Maximum Conducted Transmit Power Settings***

The following is a transmit power table (US domain) per internal antenna in the 2.4 GHz band:

<b><i>20 MHZ CHANNEL</i></b>	<b><i>40 MHZ CHANNEL</i></b>	<b><i>LEGACY DSSS RATES (2TX)</i></b>	<b><i>LEGACY OFDM RATES (2TX)</i></b>	<b><i>802.11n HT20 RATES/TURBO QAM (2TX)</i></b>	<b><i>802.11n HT40 RATES/TURBO QAM (2TX)</i></b>
1		18.0	11.5	9.5	
2		18.0	18.0	18.0	
3	(1, 5)	18.0	18.0	18.0	8.0
4	(2, 6)	18.0	18.0	18.0	11.0
5	(3, 7)	18.0	18.0	18.0	11.0
6	(4, 8)	18.0	18.0	18.0	11.0
7	(5, 9)	18.0	18.0	18.0	11.0
8	(6, 10)	18.0	18.0	18.0	11.0
9	(7, 11)	18.0	18.0	18.0	7.5
10		18.0	18.0	18.0	
11		18.0	9.5	9.5	

## 24.2 US Regulatory Domain 5 GHz Band

### 24.2.1 Internal Antenna Model

The following is a transmit power table (US domain) per internal antenna in the 5 GHz band:

<b>20 MHZ CHANNEL</b>	<b>40 MHZ CHANNEL</b>	<b>80 MHZ CHANNELS</b>	<b>LEGACY OFDM RATES (2TX)</b>	<b>802.11n HT20 RATES (2TX)</b>	<b>802.11n HT40 RATES (2TX)</b>	<b>802.11n HT80 RATES (2TX)</b>
36			13.5	12.5		
38	(36, 40)				7.0	
40			16.0	16.0		
42		(36, 40, 44, 48)				5.5
44			16.0	16.0		
46	(44, 48)				16.0	
48			16.0	16.0		
52			16.0	16.0		
54	(52, 56)				15.0	
56			16.0	16.0		
58		(52, 56, 60, 64)				7.0
60			16.0	16.0		
62	(60, 64)				9.5	
64			15.0	15.0		
100			16.0	15.0		
102	(100, 104)				8.5	
104			16.0	16.0		
106		(100, 104, 108, 112)				6.5
108			16.0	16.0		
110					15.0	
112			16.0	16.0		
114						
116			16.0	16.0		
118	(116, 120)					
120						
122		(116, 120, 124, 128)				
124						



<b>20 MHZ CHANNEL</b>	<b>40 MHZ CHANNEL</b>	<b>80 MHZ CHANNELS</b>	<b>LEGACY OFDM RATES (2TX)</b>	<b>802.11n HT20 RATES (2TX)</b>	<b>802.11n HT40 RATES (2TX)</b>	<b>802.11n HT80 RATES (2TX)</b>
126	(124, 128)					
128						
130						
132			16.0	16.0		
134	(132, 136)				15.0	
136			16.0	16.0		
138						
140			16.0	16.0		
142						
144						
149			14.0	14.0		
151	(149, 153)				9.5	
153			16.0	16.0		
155		(149, 153, 157, 161)				7.5
157			16.0	16.0		
159	(157, 161)				15.0	
161			16.0	16.0		
165			15.0	15.0		

## 24.3 EU Regulatory Domain 2.4 GHz Band

### 24.3.1 Internal Antenna Maximum Conducted Transmit Power Settings

The following is a transmit power table (EU domain) per internal antenna in the 2.4 GHz band:

<b>20 MHZ CHANNEL</b>	<b>40 MHZ CHANNEL</b>	<b>LEGACY DSSS RATES (2TX)</b>	<b>LEGACY OFDM RATES (2TX)</b>	<b>802.11n HT20 RATES/TURBO QAM (2TX)</b>	<b>802.11n HT40 RATES/TURBO QAM (2TX)</b>
1		16.5	18.0	18.0	
2		16.5	18.0	18.0	
3	(1, 5)	16.5	18.0	18.0	18.0
4	(2, 6)	16.5	18.0	18.0	18.0
5	(3, 7)	16.5	18.0	18.0	18.0
6	(4, 8)	16.5	18.0	18.0	18.0
7	(5, 9)	16.5	18.0	18.0	18.0
8	(6, 10)	16.5	18.0	18.0	18.0
9	(7, 11)	16.5	18.0	18.0	18.0
10		16.5	18.0	18.0	18.0
11		16.5	18.0	18.0	18.0
12		16.5	18.0	18.0	18.0
13		17.0	18.5	18.5	
14					

## 24.4 EU Regulatory Domain 5 GHz Band

### 24.4.1 Internal Antenna Model

The following is a transmit power table (EU domain) per internal antenna in the 5 GHz band:

<b>20 MHZ CHANNEL</b>	<b>40 MHZ CHANNEL</b>	<b>80 MHZ CHANNELS</b>	<b>LEGACY OFDM RATES (2TX)</b>	<b>802.11n HT20 RATES (2TX)</b>	<b>802.11n HT40 RATES (2TX)</b>	<b>802.11n HT80 RATES (2TX)</b>
36			14.0	14.0		
38	(36, 40)				14.0	
40			15.0	15.0		
42		(36, 40, 44, 48)				14.5
44			15.0	15.0		
46	(44, 48)				15.0	
48			14.0	14.0		
52			11.5	11.5		
54	(52, 56)				12.0	
56			11.5	11.5		
58		(52, 56, 60, 64)				12.5
60			11.5	11.5		
62	(60, 64)				12.0	
64			11.0	11.5		
100			18.0	18.0		
102	(100, 104)				14.5	
104			18.0	18.0		
106		(100, 104, 108, 112)				14.0
108			18.0	18.0		
110					14.5	
112			18.0	18.0		
114						
116			18.0	18.0		
118	(116, 120)				14.5	
120			18.0	18.0		
122		(116, 120, 124, 128)				14.0
124			18.0	18.0		
126	(124, 128)				15.0	
128			18.0	18.0		

<b>20 MHZ CHANNEL</b>	<b>40 MHZ CHANNEL</b>	<b>80 MHZ CHANNELS</b>	<b>LEGACY OFDM RATES (2TX)</b>	<b>802.11n HT20 RATES (2TX)</b>	<b>802.11n HT40 RATES (2TX)</b>	<b>802.11n HT80 RATES (2TX)</b>
130						
132			18.0	18.0		
134	(132, 136)				15.0	
136			18.0	18.0		
138						
140			18.0	18.0		
142						
144						
149						
151	(149, 153)					
153						
155		(149, 153, 157, 161)				
157						
159	(157, 161)					
161						
165						

## 24.5 Japan Regulatory Domain 2.4 GHz Band

### 24.5.1 Internal Antenna Maximum Conducted Transmit Power Settings

The following is a transmit power table (Japan domain) per internal antenna in the 2.4 GHz band:

<b>20 MHZ CHANNEL</b>	<b>40 MHZ CHANNEL</b>	<b>LEGACY DSSS RATES (2TX)</b>	<b>LEGACY OFDM RATES (2TX)</b>	<b>802.11n HT20 RATES/TURBO QAM (2TX)</b>	<b>802.11n HT40 RATES/TURBO QAM (2TX)</b>
1		13.0	17.0	14.0	
2		13.0	17.0	14.0	
3	(1, 5)	13.0	17.0	14.0	14.0
4	(2, 6)	13.0	17.0	14.0	14.0
5	(3, 7)	13.0	17.0	14.0	14.0
6	(4, 8)	13.0	17.0	14.0	14.0
7	(5, 9)	13.0	17.0	14.0	14.0
8	(6, 10)	13.0	17.0	14.0	14.0
9	(7, 11)	13.0	17.0	14.0	14.0
10		13.0	17.0	14.0	14.0
11		13.0	17.0	14.0	14.0
12		13.0	17.0	14.0	14.0
13		13.0	17.0	14.0	
14					

## 24.6 Japan Regulatory Domain 5 GHz Band

### 24.6.1 Internal Antenna Model

The following is a transmit power table (Japan domain) per internal antenna in the 5 GHz band:

<b>20 MHZ CHANNEL</b>	<b>40 MHZ CHANNEL</b>	<b>80 MHZ CHANNELS</b>	<b>LEGACY OFDM RATES (2TX)</b>	<b>802.11n HT20 RATES (2TX)</b>	<b>802.11n HT40 RATES (2TX)</b>	<b>802.11n HT80 RATES (2TX)</b>
36			14.0	11.0		
38	(36, 40)				11.0	
40			14.0	11.0		
42		(36, 40, 44, 48)				12.0
44			14.0	11.0		
46	(44, 48)				11.0	
48			14.0	11.0		
52			14.0	11.0		
54	(52, 56)				11.0	
56			14.0	11.0		
58		(52, 56, 60, 64)				12.0
60			14.0	11.0		
62	(60, 64)				11.0	
64			14.0	11.0		
100			18,0	18,0		
102	(100, 104)				17.0	
104			18,0	18,0		
106		(100, 104, 108, 112)				17.0
108			18,0	18,0		
110					17.0	
112			18,0	18,0		
114						
116			18,0	18,0		
118	(116, 120)				17.0	
120			18,0	18,0		
122		(116, 120, 124, 128)				17.0
124			18,0	18,0		
126	(124, 128)				17.0	
128			18,0	18,0		

<b>20 MHZ CHANNEL</b>	<b>40 MHZ CHANNEL</b>	<b>80 MHZ CHANNELS</b>	<b>LEGACY OFDM RATES (2TX)</b>	<b>802.11n HT20 RATES (2TX)</b>	<b>802.11n HT40 RATES (2TX)</b>	<b>802.11n HT80 RATES (2TX)</b>
130						
132			18,0	18,0		
134	(132, 136)				17.0	
136			18,0	18,0		
138						
140			18,0	18,0		
142						
144						
149						
151	(149, 153)					
153						
155		(149, 153, 157, 161)				
157						
159	(157, 161)					
161						
165						

## 24.7 NCC Regulatory Domain 2.4 GHz Band

### 24.7.1 Internal Antenna Maximum Conducted Transmit Power Settings

The following is a transmit power table (NCC domain) per internal antenna in the 2.4 GHz band:

<b>20 MHZ CHANNEL</b>	<b>40 MHZ CHANNEL</b>	<b>LEGACY DSSS RATES (2TX)</b>	<b>LEGACY OFDM RATES (2TX)</b>	<b>802.11n HT20 RATES/TURBO QAM (2TX)</b>	<b>802.11n HT40 RATES/TURBO QAM (2TX)</b>
1		18.0	11.5	9.5	
2		18.0	18.0	18.0	
3	(1, 5)	18.0	18.0	18.0	8.0
4	(2, 6)	18.0	18.0	18.0	11.0
5	(3, 7)	18.0	18.0	18.0	11.0
6	(4, 8)	18.0	18.0	18.0	11.0
7	(5, 9)	18.0	18.0	18.0	11.0
8	(6, 10)	18.0	18.0	18.0	11.0
9	(7, 11)	18.0	18.0	18.0	7.5
10		18.0	18.0	18.0	
11		18.0	9.5	9.5	



## 24.8 NCC Regulatory Domain 5 GHz Band

### 24.8.1 Internal Antenna Model

The following is a transmit power table (NCC domain) per internal antenna in the 5 GHz band:

<b>20 MHZ CHANNEL</b>	<b>40 MHZ CHANNEL</b>	<b>80 MHZ CHANNELS</b>	<b>LEGACY OFDM RATES (2TX)</b>	<b>802.11n HT20 RATES (2TX)</b>	<b>802.11n HT40 RATES (2TX)</b>	<b>802.11n HT80 RATES (2TX)</b>
36						
38	(36, 40)					
40						
42		(36, 40, 44, 48)				
44						
46	(44, 48)					
48						
52						
54	(52, 56)					
56			10.0	10.0		
58		(52, 56, 60, 64)				
60			10.0	10.0		
62	(60, 64)				9.5	
64			9.5	9.5		
100			16.0	15.0		
102	(100, 104)				8.5	
104			16.0	16.0		
106		(100, 104, 108, 112)				6.5
108			16.0	16.0		
110					16.0	
112			16.0	16.0		
114						
116			16.0	16.0		
118	(116, 120)					
120						
122		(116, 120, 124, 128)				
124						

<b>20 MHZ CHANNEL</b>	<b>40 MHZ CHANNEL</b>	<b>80 MHZ CHANNELS</b>	<b>LEGACY OFDM RATES (2TX)</b>	<b>802.11n HT20 RATES (2TX)</b>	<b>802.11n HT40 RATES (2TX)</b>	<b>802.11n HT80 RATES (2TX)</b>
126	(124, 128)					
128						
130						
132			16.0	16.0		
134	(132, 136)				15.0	
136			16.0	16.0		
138						
140			16.0	13.5		
142						
144						
149			16.0	16.0		
151	(149, 153)				15.0	
153			16.0	16.0		
155		(149, 153, 157, 161)				14.0
157			16.0	16.0		
159	(157, 161)				15.0	
161			16.0	16.0		
165			16.0	16.0		

# 25

## ***AP7562 Regulatory Domains***

### **25.1 US Regulatory Domain 2.4 GHz Band**

#### ***25.1.1 Dipole Antenna Maximum Conducted Transmit Power Settings***

The following is a transmit power table (US domain) per internal antenna in the 2.4 GHz band:

<b><i>20 MHZ CHANNEL</i></b>	<b><i>40 MHZ CHANNEL</i></b>	<b><i>LEGACY DSSS RATES (2TX)</i></b>	<b><i>LEGACY OFDM RATES (2TX)</i></b>	<b><i>802.11n HT20 RATES/TURBO QAM (2TX)</i></b>	<b><i>802.11n HT40 RATES/TURBO QAM (2TX)</i></b>
1		20.0	15.0	11.0	
2		21.0	20.0	20.0	
3	(1, 5)	21.0	20.0	20.0	10.0
4	(2, 6)	21.0	20.0	20.0	14.0
5	(3, 7)	21.0	20.0	20.0	14.0
6	(4, 8)	21.0	20.0	20.0	14.0
7	(5, 9)	21.0	20.0	20.0	14.0
8	(6, 10)	21.0	20.0	20.0	14.0
9	(7, 11)	21.0	20.0	20.0	14.0
10		21.0	20.0	20.0	
11		21.0	16.0	15.0	

Dipole antenna, peak gain = 5.3dBi

### 25.1.2 Panel Antenna Maximum Conducted Transmit Power Settings

The following is a transmit power table (US domain) per panel antenna in the 2.4 GHz band:

<b>20 MHZ CHANNEL</b>	<b>40 MHZ CHANNEL</b>	<b>LEGACY DSSS RATES (2TX)</b>	<b>LEGACY OFDM RATES (2TX)</b>	<b>802.11n HT20 RATES/TURBO QAM (2TX)</b>	<b>802.11n HT40 RATES/TURBO QAM (2TX)</b>
1		20.0	16.0	14.0	
2		21.0	21.0	20.0	
3	(1, 5)	21.0	21.0	20.0	13.0
4	(2, 6)	21.0	21.0	20.0	14.0
5	(3, 7)	21.0	21.0	20.0	14.0
6	(4, 8)	21.0	21.0	20.0	14.0
7	(5, 9)	21.0	21.0	20.0	14.0
8	(6, 10)	21.0	21.0	20.0	14.0
9	(7, 11)	21.0	21.0	20.0	12.0
10		21.0	21.0	20.0	
11		20.0	16.0	18.0	

Panel antenna, peak gain = 6.5 dBi

### 25.1.3 Polarized-Panel Antenna Maximum Conducted Transmit Power Settings

The following is a transmit power table (US domain) per polarized-panel antenna in the 2.4 GHz band:

<b>20 MHZ CHANNEL</b>	<b>40 MHZ CHANNEL</b>	<b>LEGACY DSSS RATES (2TX)</b>	<b>LEGACY OFDM RATES (2TX)</b>	<b>802.11n HT20 RATES/TURBO QAM (2TX)</b>	<b>802.11n HT40 RATES/TURBO QAM (2TX)</b>
1		20.0	16.0	13.0	
2		21.0	20.0	18.0	
3	(1, 5)	21.0	20.0	18.0	13.0
4	(2, 6)	21.0	20.0	18.0	14.0
5	(3, 7)	21.0	20.0	18.0	14.0
6	(4, 8)	21.0	20.0	18.0	14.0
7	(5, 9)	21.0	20.0	18.0	14.0
8	(6, 10)	21.0	20.0	18.0	14.0
9	(7, 11)	21.0	20.0	18.0	12.0
10		21.0	20.0	18.0	
11		20.0	17.0	14.0	

Polarized-panel antenna, peak gain = 6 dBi

## 25.2 US Regulatory Domain 5 GHz Band

### 25.2.1 Dipole Antenna Model

The following is a transmit power table (US domain) per dipole antenna in the 5 GHz band:

<b>20 MHZ CHANNEL</b>	<b>40 MHZ CHANNEL</b>	<b>80 MHZ CHANNELS</b>	<b>LEGACY OFDM RATES (2TX)</b>	<b>802.11n HT20 RATES (2TX)</b>	<b>802.11n HT40 RATES (2TX)</b>	<b>802.11n HT80 RATES (2TX)</b>
36			16.0	12.0		
38	(36, 40)		16.0	12.0	12.0	
40			16.0	12.0		
42		(36, 40, 44, 48)	16.0	12.0		12.0
44			16.0	12.0		
46	(44, 48)		16.0	12.0	12.0	
48			16.0	12.0		
52			20.0	14.0		
54	(52, 56)		20.0	14.0	17.0	
56			20.0	14.0		
58		(52, 56, 60, 64)	20.0	14.0		9.0
60			20.0	14.0		
62	(60, 64)		20.0	14.0	17.0	
64			19.0	14.0		
100			18.0	14.0		
102	(100, 104)		20.0	14.0	13.0	
104			20.0	14.0		
106		(100, 104, 108, 112)	20.0	14.0		11.0
108			20.0	14.0		
110			20.0	14.0	15.0	
112			20.0	14.0		
114			20.0	14.0		
116			20.0	14.0		
118	(116, 120)		20.0	14.0	15.0	
120			20.0	14.0		
122		(116, 120, 124, 128)	20.0	14.0		19.0
124			20.0	14.0		

<b>20 MHZ CHANNEL</b>	<b>40 MHZ CHANNEL</b>	<b>80 MHZ CHANNELS</b>	<b>LEGACY OFDM RATES (2TX)</b>	<b>802.11n HT20 RATES (2TX)</b>	<b>802.11n HT40 RATES (2TX)</b>	<b>802.11n HT80 RATES (2TX)</b>
126	(124, 128)		20.0	14.0	15.0	
128			20.0	14.0		
130			20.0	14.0		
132			20.0	14.0		
134	(132, 136)		20.0	14.0	16.0	
136			20.0	14.0		
138			20.0	14.0		
140			18.0	14.0		
142			18.0	14.0	17.0	
144			20.0	14.0		
149			17.0	17.0		
151	(149, 153)		20.0	20.0	15.0	
153			20.0	20.0		
155		(149, 153, 157, 161)	20.0	20.0		15.0
157			20.0	20.0		
159	(157, 161)		20.0	20.0	18.0	
161			20.0	20.0		
165			18.0	17.0		

Dipole antenna, peak gain = 7.3 dBi

For indoor placement, the power can be set as high as 20dBm

## 25.2.2 Panel Antenna Model

The following is a transmit power table (US domain) per panel antenna in the 5 GHz band:

<b>20 MHZ CHANNEL</b>	<b>40 MHZ CHANNEL</b>	<b>80 MHZ CHANNELS</b>	<b>LEGACY OFDM RATES (2TX)</b>	<b>802.11n HT20 RATES (2TX)</b>	<b>802.11n HT40 RATES (2TX)</b>	<b>802.11n HT80 RATES (2TX)</b>
36			20.0	19.0		
38	(36, 40)		20.0	20.0	16.0	
40			20.0	20.0		
42		(36, 40, 44, 48)	20.0	20.0		14.0
44			20.0	20.0		
46	(44, 48)		20.0	20.0	20.0	
48			20.0	20.0		
52			20.0	16.0		
54	(52, 56)		20.0	16.0	18.0	
56			20.0	16.0		
58		(52, 56, 60, 64)	20.0	16.0		11.0
60			20.0	16.0		
62	(60, 64)		20.0	16.0	18.0	
64			19.0	16.0		
100			18.0	16.0		
102	(100, 104)		20.0	16.0	14.0	
104			20.0	16.0		
106		(100, 104, 108, 112)	20.0	16.0		11.0
108			20.0	16.0		
110			20.0	16.0	19.0	
112			20.0	16.0		
114			20.0	16.0		
116			20.0	16.0		
118	(116, 120)		20.0	16.0	19.0	
120			20.0	16.0		
122		(116, 120, 124, 128)	20.0	16.0		19.0
124			20.0	16.0		
126	(124, 128)		20.0	16.0	19.0	
128			20.0	16.0		



<b>20 MHZ CHANNEL</b>	<b>40 MHZ CHANNEL</b>	<b>80 MHZ CHANNELS</b>	<b>LEGACY OFDM RATES (2TX)</b>	<b>802.11n HT20 RATES (2TX)</b>	<b>802.11n HT40 RATES (2TX)</b>	<b>802.11n HT80 RATES (2TX)</b>
130			20.0	16.0		
132			20.0	16.0		
134	(132, 136)		20.0	16.0	17.0	
136			20.0	16.0		
138			20.0	16.0		
140			18.0	16.0		
142			18.0	16.0	19.0	
144			20.0	16.0		
149			17.0	15.0		
151	(149, 153)		20.0	20.0	14.0	
153			20.0	20.0		
155		(149, 153, 157, 161)	20.0	20.0		15.0
157			20.0	20.0		
159	(157, 161)		20.0	20.0	15.0	
161			20.0	20.0		
165			18.0	16.0		

Panel antenna, peak gain = 6 dBi

### 25.2.3 Polarized-Panel Antenna Model

The following is a transmit power table (US domain) per polarized-panel antenna in the 5 GHz band:

<b>20 MHZ CHANNEL</b>	<b>40 MHZ CHANNEL</b>	<b>80 MHZ CHANNELS</b>	<b>LEGACY OFDM RATES (2TX)</b>	<b>802.11n HT20 RATES (2TX)</b>	<b>802.11n HT40 RATES (2TX)</b>	<b>802.11n HT80 RATES (2TX)</b>
36			19.0	18.0		
38	(36, 40)		20.0	20.0	15.0	
40			20.0	20.0		
42		(36, 40, 44, 48)	20.0	20.0		11.0
44			20.0	20.0		
46	(44, 48)		20.0	20.0	19.0	
48			20.0	20.0		
52			20.0	17.0		
54	(52, 56)		20.0	17.0	18.0	
56			20.0	17.0		
58		(52, 56, 60, 64)	20.0	17.0		11.0
60			20.0	17.0		
62	(60, 64)		20.0	17.0	18.0	
64			19.0	17.0		
100			18.0	17.0		
102	(100, 104)		20.0	17.0	14.0	
104			20.0	17.0		
106		(100, 104, 108, 112)	20.0	17.0		12.0
108			20.0	17.0		
110			20.0	17.0	18.0	
112			20.0	17.0		
114			20.0	17.0		
116			20.0	17.0		
118	(116, 120)		20.0	17.0	18.0	
120			20.0	17.0		
122		(116, 120, 124, 128)	20.0	17.0		18.0
124			20.0	17.0		
126	(124, 128)		20.0	17.0	18.0	
128			20.0	17.0		
130			20.0	17.0		
132			20.0	17.0		

<b>20 MHZ CHANNEL</b>	<b>40 MHZ CHANNEL</b>	<b>80 MHZ CHANNELS</b>	<b>LEGACY OFDM RATES (2TX)</b>	<b>802.11n HT20 RATES (2TX)</b>	<b>802.11n HT40 RATES (2TX)</b>	<b>802.11n HT80 RATES (2TX)</b>
134	(132, 136)		20.0	17.0	17.0	
136			20.0	17.0		
138			20.0	17.0		
140			17.0	15.0		
142			17.0	15.0	17.0	
144			20.0	17.0		
149			16.0	15.0		
151	(149, 153)		20.0	20.0	13.0	
153			20.0	20.0		
155		(149, 153, 157, 161)	20.0	20.0		12.0
157			20.0	20.0		
159	(157, 161)		20.0	20.0	15.0	
161			20.0	20.0		
165			17.0	16.0		

Polarized-panel antenna, peak gain = 9.2 dBi

## 25.3 EU Regulatory Domain 2.4 GHz Band

### 25.3.1 Dipole Antenna Maximum Conducted Transmit Power Settings

The following is a transmit power table (EU domain) per dipole antenna in the 2.4 GHz band:

<b>20 MHZ CHANNEL</b>	<b>40 MHZ CHANNEL</b>	<b>LEGACY DSSS RATES (2TX)</b>	<b>LEGACY OFDM RATES (2TX)</b>	<b>802.11n HT20 RATES/TURBO QAM (2TX)</b>	<b>802.11n HT40 RATES/TURBO QAM (2TX)</b>
1		8.5	9.5	4.5	
2		8.5	9.5	4.5	
3	(1, 5)	8.5	9.5	4.5	4.5
4	(2, 6)	8.5	9.5	4.5	4.5
5	(3, 7)	8.5	9.5	4.5	4.5
6	(4, 8)	8.5	9.5	4.5	4.5
7	(5, 9)	8.5	9.5	4.5	4.5
8	(6, 10)	8.5	9.5	4.5	4.5
9	(7, 11)	8.5	9.5	4.5	4.5
10		8.5	9.5	4.5	4.5
11		8.5	9.5	4.5	4.5
12		8.5	9.5	4.5	
13		8.5	9.5	4.5	

Dipole antenna, peak gain = 10.5 dBi

### 25.3.2 Panel Antenna Maximum Conducted Transmit Power Settings

The following is a transmit power table (EU domain) per panel antenna in the 2.4 GHz band:

<b>20 MHZ CHANNEL</b>	<b>40 MHZ CHANNEL</b>	<b>LEGACY DSSS RATES (2TX)</b>	<b>LEGACY OFDM RATES (2TX)</b>	<b>802.11n HT20 RATES/TURBO QAM (2TX)</b>	<b>802.11n HT40 RATES/TURBO QAM (2TX)</b>
1		11.0	12.0	7.0	
2		11.0	12.0	7.0	
3	(1, 5)	11.0	12.0	7.0	7.0
4	(2, 6)	11.0	12.0	7.0	7.0
5	(3, 7)	11.0	12.0	7.0	7.0
6	(4, 8)	11.0	12.0	7.0	7.0
7	(5, 9)	11.0	12.0	7.0	7.0
8	(6, 10)	11.0	12.0	7.0	7.0
9	(7, 11)	11.0	12.0	7.0	7.0
10		11.0	12.0	7.0	7.0
11		11.0	12.0	7.0	7.0
12		11.0	12.0	7.0	
13		11.0	12.0	7.0	

Panel antenna, peak gain = 8 dBi

### 25.3.3 Polarized-Panel Antenna Maximum Conducted Transmit Power Settings

The following is a transmit power table (EU domain) per polarized panel antenna in the 2.4 GHz band:

<b>20 MHZ CHANNEL</b>	<b>40 MHZ CHANNEL</b>	<b>LEGACY DSSS RATES (2TX)</b>	<b>LEGACY OFDM RATES (2TX)</b>	<b>802.11n HT20 RATES/TURBO QAM (2TX)</b>	<b>802.11n HT40 RATES/TURBO QAM (2TX)</b>
1		9.5	10.5	5.5	
2		9.5	10.5	5.5	
3	(1, 5)	9.5	10.5	5.5	5.5
4	(2, 6)	9.5	10.5	5.5	5.5
5	(3, 7)	9.5	10.5	5.5	5.5
6	(4, 8)	9.5	10.5	5.5	5.5
7	(5, 9)	9.5	10.5	5.5	5.5
8	(6, 10)	9.5	10.5	5.5	5.5
9	(7, 11)	9.5	10.5	5.5	5.5
10		9.5	10.5	5.5	5.5
11		9.5	10.5	5.5	5.5
12		9.5	10.5	5.5	
13		9.5	10.5	5.5	

Polarized panel antenna, peak gain = 9.5 dBi

## 25.4 EU Regulatory Domain 5 GHz Band

### 25.4.1 Dipole Antenna Model

The following is a transmit power table (EU domain) per dipole antenna in the 5 GHz band:

<b>20 MHZ CHANNEL</b>	<b>40 MHZ CHANNEL</b>	<b>80 MHZ CHANNELS</b>	<b>LEGACY OFDM RATES (2TX)</b>	<b>802.11n HT20 RATES (2TX)</b>	<b>802.11n HT40 RATES (2TX)</b>	<b>802.11n HT80 RATES (2TX)</b>
36			12.5	7.5		
38	(36, 40)		12.5	7.5	7.5	
40			12.5	7.5		
42		(36, 40, 44, 48)	12.5	7.5		7.5
44			12.5	7.5		
46	(44, 48)		12.5	7.5	7.5	
48			12.5	7.5		
52			12.5	7.5		
54	(52, 56)		12.5	7.5	7.5	
56			12.5	7.5		
58		(52, 56, 60, 64)	12.5	7.5		7.5
60			12.5	7.5		
62	(60, 64)		12.5	7.5	7.5	
64			12.5	7.5		
100			19.5	14.5		
102	(100, 104)		19.5	14.5	14.5	
104			19.5	14.5		
106		(100, 104, 108, 112)	19.5	14.5		14.5
108			19.5	14.5		
110			19.5	14.5	14.5	
112			19.5	14.5		
114			19.5	14.5		
116			19.5	14.5		
118	(116, 120)		19.5	14.5	14.5	
120			19.5	14.5		
122		(116, 120, 124, 128)	19.5	14.5		14.5
124			19.5	14.5		

<b>20 MHZ CHANNEL</b>	<b>40 MHZ CHANNEL</b>	<b>80 MHZ CHANNELS</b>	<b>LEGACY OFDM RATES (2TX)</b>	<b>802.11n HT20 RATES (2TX)</b>	<b>802.11n HT40 RATES (2TX)</b>	<b>802.11n HT80 RATES (2TX)</b>
126	(124, 128)		19.5	14.5	14.5	
128			19.5	14.5		
130			19.5	14.5		
132			19.5	14.5		
134	(132, 136)		19.5	14.5	14.5	
136			19.5	14.5		
138			19.5	14.5		
140			19.5	14.5		
142			19.5	14.5	14.5	
144			19.5	14.5		

Dipole antenna, peak gain = 10.5 dBi



## 25.4.2 Panel Antenna Model

The following is a transmit power table (EU domain) per panel antenna in the 5 GHz band:

<b>20 MHZ CHANNEL</b>	<b>40 MHZ CHANNEL</b>	<b>80 MHZ CHANNELS</b>	<b>LEGACY OFDM RATES (2TX)</b>	<b>802.11n HT20 RATES (2TX)</b>	<b>802.11n HT40 RATES (2TX)</b>	<b>802.11n HT80 RATES (2TX)</b>
36			11.0	6.0		
38	(36, 40)		11.0	6.0	6.0	
40			11.0	6.0		
42		(36, 40, 44, 48)	11.0	6.0		6.0
44			11.0	6.0		
46	(44, 48)		11.0	6.0	6.0	
48			11.0	6.0		
52			11.0	6.0		
54	(52, 56)		11.0	6.0	6.0	
56			11.0	6.0		
58		(52, 56, 60, 64)	11.0	6.0		6.0
60			11.0	6.0		
62	(60, 64)		11.0	6.0	6.0	
64			11.0	6.0		
100			18.0	13.0		
102	(100, 104)		19.5	13.0	13.0	
104			18.0	13.0		
106		(100, 104, 108, 112)	18.0	13.0		13.0
108			18.0	13.0		
110			18.0	13.0	13.0	
112			18.0	13.0		
114			18.0	13.0		
116			18.0	13.0		
118	(116, 120)		18.0	13.0	13.0	
120			18.0	13.0		
122		(116, 120, 124, 128)	18.0	13.0		13.0
124			18.0	13.0		
126	(124, 128)		18.0	13.0	13.0	
128			18.0	13.0		

<b>20 MHZ CHANNEL</b>	<b>40 MHZ CHANNEL</b>	<b>80 MHZ CHANNELS</b>	<b>LEGACY OFDM RATES (2TX)</b>	<b>802.11n HT20 RATES (2TX)</b>	<b>802.11n HT40 RATES (2TX)</b>	<b>802.11n HT80 RATES (2TX)</b>
130			18.0	13.0		
132			18.0	13.0		
134	(132, 136)		18.0	13.0	13.0	
136			18.0	13.0		
138			18.0	13.0		
140			18.0	13.0		
142			18.0	13.0	13.0	
144			18.0	13.0		

Panel antenna, peak gain = 12 dBi

### 25.4.3 Polarized-Panel Antenna Model

The following is a transmit power table (EU domain) per polarized-panel antenna in the 5 GHz band:

<b>20 MHZ CHANNEL</b>	<b>40 MHZ CHANNEL</b>	<b>80 MHZ CHANNELS</b>	<b>LEGACY OFDM RATES (2TX)</b>	<b>802.11n HT20 RATES (2TX)</b>	<b>802.11n HT40 RATES (2TX)</b>	<b>802.11n HT80 RATES (2TX)</b>
36			13.5	9.0		
38	(36, 40)		13.5	9.0	9.0	
40			13.5	9.0		
42		(36, 40, 44, 48)	13.5	9.0		9.0
44			13.5	9.0		
46	(44, 48)		13.5	9.0	9.0	
48			13.5	9.0		
52			13.5	9.0		
54	(52, 56)		13.5	9.0	9.0	
56			13.5	9.0		
58		(52, 56, 60, 64)	13.5	9.0		9.0
60			13.5	9.0		
62	(60, 64)		13.5	9.0	9.0	
64			13.5	9.0		
100			20.0	16.0		
102	(100, 104)		20.0	16.0	16.0	
104			20.0	16.0		
106		(100, 104, 108, 112)	20.0	16.0		16.0
108			20.0	16.0		
110			20.0	16.0	16.0	
112			20.0	16.0		
114			20.0	16.0		
116			20.0	16.0		
118	(116, 120)		20.0	16.0	16.0	
120			20.0	16.0		
122		(116, 120, 124, 128)	20.0	16.0		16.0
124			20.0	16.0		
126	(124, 128)		20.0	16.0	16.0	
128			20.0	16.0		

<b>20 MHZ CHANNEL</b>	<b>40 MHZ CHANNEL</b>	<b>80 MHZ CHANNELS</b>	<b>LEGACY OFDM RATES (2TX)</b>	<b>802.11n HT20 RATES (2TX)</b>	<b>802.11n HT40 RATES (2TX)</b>	<b>802.11n HT80 RATES (2TX)</b>
130			20.0	16.0		
132			20.0	16.0		
134	(132, 136)		20.0	16.0	16.0	
136			20.0	16.0		
138			20.0	16.0		
140			20.0	16.0		
142			20.0	16.0	16.0	
144			20.0	16.0		

Polarized panel antenna, peak gain = 9.2dBi

## 25.5 Japan Regulatory Domain 2.4 GHz Band

### 25.5.1 Dipole Antenna Maximum Conducted Transmit Power Settings

The following is a transmit power table (Japan domain) per dipole antenna in the 2.4 GHz band:

<b>20 MHZ CHANNEL</b>	<b>40 MHZ CHANNEL</b>	<b>LEGACY DSSS RATES (2TX)</b>	<b>LEGACY OFDM RATES (2TX)</b>	<b>802.11n HT20 RATES/TURBO QAM (2TX)</b>	<b>802.11n HT40 RATES/TURBO QAM (2TX)</b>
1		12.0	14.0	11.0	
2		12.0	14.0	11.0	
3	(1, 5)	12.0	14.0	11.0	11.0
4	(2, 6)	12.0	14.0	11.0	11.0
5	(3, 7)	12.0	14.0	11.0	11.0
6	(4, 8)	12.0	14.0	11.0	11.0
7	(5, 9)	12.0	14.0	11.0	11.0
8	(6, 10)	12.0	14.0	11.0	11.0
9	(7, 11)	12.0	14.0	11.0	11.0
10		12.0	14.0	11.0	11.0
11		12.0	14.0	11.0	11.0
12		12.0	14.0	11.0	
13		12.0	14.0	11.0	

Dipole antenna, peak gain = 10.5 dBi

### 25.5.2 Panel Antenna Maximum Conducted Transmit Power Settings

The following is a transmit power table (Japan domain) per panel antenna in the 2.4 GHz band:

<b>20 MHZ CHANNEL</b>	<b>40 MHZ CHANNEL</b>	<b>LEGACY DSSS RATES (2TX)</b>	<b>LEGACY OFDM RATES (2TX)</b>	<b>802.11n HT20 RATES/TURBO QAM (2TX)</b>	<b>802.11n HT40 RATES/TURBO QAM (2TX)</b>
1		18.0	20.0	19.0	
2		18.0	20.0	19.0	
3	(1, 5)	18.0	20.0	19.0	19.0
4	(2, 6)	18.0	20.0	19.0	19.0
5	(3, 7)	18.0	20.0	19.0	19.0
6	(4, 8)	18.0	20.0	19.0	19.0
7	(5, 9)	18.0	20.0	19.0	19.0
8	(6, 10)	18.0	20.0	19.0	19.0
9	(7, 11)	18.0	20.0	19.0	19.0
10		18.0	20.0	19.0	19.0
11		18.0	20.0	19.0	19.0
12		18.0	20.0	19.0	
13		18.0	20.0	19.0	

Panel antenna, peak gain = 8 dBi

### 25.5.3 Polarized-Panel Antenna Maximum Conducted Transmit Power Settings

The following is a transmit power table (Japan domain) per polarized panel antenna in the 2.4 GHz band:

<b>20 MHZ CHANNEL</b>	<b>40 MHZ CHANNEL</b>	<b>LEGACY DSSS RATES (2TX)</b>	<b>LEGACY OFDM RATES (2TX)</b>	<b>802.11n HT20 RATES/TURBO QAM (2TX)</b>	<b>802.11n HT40 RATES/TURBO QAM (2TX)</b>
1		16.0	20.0	17.0	
2		16.0	20.0	17.0	
3	(1, 5)	16.0	20.0	17.0	17.0
4	(2, 6)	16.0	20.0	17.0	17.0
5	(3, 7)	16.0	20.0	17.0	17.0
6	(4, 8)	16.0	20.0	17.0	17.0
7	(5, 9)	16.0	20.0	17.0	17.0
8	(6, 10)	16.0	20.0	17.0	17.0
9	(7, 11)	16.0	20.0	17.0	17.0
10		16.0	20.0	17.0	17.0
11		16.0	20.0	17.0	17.0
12		16.0	20.0	17.0	
13		16.0	20.0	17.0	

Polarized panel antenna, peak gain = 9.7 dBi

## 25.6 Japan Regulatory Domain 5 GHz Band

### 25.6.1 Dipole Antenna Model

The following is a transmit power table (Japan domain) per dipole antenna in the 5 GHz band:

<b>20 MHZ CHANNEL</b>	<b>40 MHZ CHANNEL</b>	<b>80 MHZ CHANNELS</b>	<b>LEGACY OFDM RATES (1TX)</b>	<b>802.11n HT20 RATES (3TX)</b>	<b>802.11n HT40 RATES (3TX)</b>	<b>802.11n HT80 RATES (3TX)</b>
36			13.0	8.0		
38	(36, 40)		13.0	8.0	8.0	
40			13.0	8.0		
42		(36, 40, 44, 48)	13.0	8.0		8.0
44			13.0	8.0		
46	(44, 48)		13.0	8.0	8.0	
48			13.0	8.0		
52			13.0	8.0		
54	(52, 56)		13.0	8.0	8.0	
56			13.0	8.0		
58		(52, 56, 60, 64)	13.0	8.0		8.0
60			13.0	8.0		
62	(60, 64)		13.0	8.0	7.5	
64			13.0	8.0		
100			20.0	15.0		
102	(100, 104)		20.0	15.0	15.0	
104			20.0	15.0		
106		(100, 104, 108, 112)	20.0	15.0		15.0
108			20.0	15.0		
110			20.0	15.0	15.0	
112			20.0	15.0		
114			20.0	15.0		
116			20.0	15.0		
118	(116, 120)		20.0	15.0	15.0	
120			20.0	15.0		
122		(116, 120, 124, 128)	20.0	15.0		15.0
124			20.0	15.0		



<b>20 MHZ CHANNEL</b>	<b>40 MHZ CHANNEL</b>	<b>80 MHZ CHANNELS</b>	<b>LEGACY OFDM RATES (1TX)</b>	<b>802.11n HT20 RATES (3TX)</b>	<b>802.11n HT40 RATES (3TX)</b>	<b>802.11n HT80 RATES (3TX)</b>
126	(124, 128)		20.0	15.0	14.5	
128			20.0	15.0		
130			20.0	15.0		
132			20.0	15.0		
134	(132, 136)		20.0	15.0	15.0	
136			20.0	15.0		
138			20.0	15.0		
140			20.0	15.0		
142			20.0	15.0		
144			20.0	15.0		

Dipole antenna, peak gain = 10.5 dBi

## 25.6.2 Panel Antenna Model

The following is a transmit power table (Japan domain) per panel antenna in the 5 GHz band:

<b>20 MHZ CHANNEL</b>	<b>40 MHZ CHANNEL</b>	<b>80 MHZ CHANNELS</b>	<b>LEGACY OFDM RATES (1TX)</b>	<b>802.11n HT20 RATES (3TX)</b>	<b>802.11n HT40 RATES (3TX)</b>	<b>802.11n HT80 RATES (3TX)</b>
36			11.0	6.0		
38	(36, 40)		11.0	6.0	6.0	
40			11.0	6.0		
42		(36, 40, 44, 48)	11.0	6.0		6.0
44			11.0	6.0		
46	(44, 48)		11.0	6.0	6.0	
48			11.0	6.0		
52			11.0	6.0		
54	(52, 56)		11.0	6.0	6.0	
56			11.0	6.0		
58		(52, 56, 60, 64)	11.0	6.0		6.0
60			11.0	6.0		
62	(60, 64)		11.0	6.0	6.0	
64			11.0	6.0		
100			18.0	13.0		
102	(100, 104)		18.0	13.0	13.0	
104			18.0	13.0		
106		(100, 104, 108, 112)	18.0	13.0		13.0
108			18.0	13.0		
110			18.0	13.0	13.0	
112			18.0	13.0		
114			18.0	13.0		
116			18.0	13.0		
118	(116, 120)		18.0	13.0	13.0	
120			18.0	13.0		
122		(116, 120, 124, 128)	18.0	13.0		13.0
124			18.0	13.0		
126	(124, 128)		18.0	13.0	13.0	
128			18.0	13.0		

<b>20 MHZ CHANNEL</b>	<b>40 MHZ CHANNEL</b>	<b>80 MHZ CHANNELS</b>	<b>LEGACY OFDM RATES (1TX)</b>	<b>802.11n HT20 RATES (3TX)</b>	<b>802.11n HT40 RATES (3TX)</b>	<b>802.11n HT80 RATES (3TX)</b>
130			18.0	13.0		
132			18.0	13.0		
134	(132, 136)		18.0	13.0	13.0	
136			18.0	13.0		
138			18.0	13.0		
140			18.0	13.0		
142			18.0	13.0		
144			18.0	13.0		

Panel antenna, peak gain = 12 dBi

### 25.6.3 Polarized-Panel Antenna Model

The following is a transmit power table (Japan domain) per polarized-panel antenna in the 5 GHz band:

<b>20 MHZ CHANNEL</b>	<b>40 MHZ CHANNEL</b>	<b>80 MHZ CHANNELS</b>	<b>LEGACY OFDM RATES (2TX)</b>	<b>802.11n HT20 RATES (2TX)</b>	<b>802.11n HT40 RATES (2TX)</b>	<b>802.11n HT80 RATES (2TX)</b>
36			14.0	9.0		
38	(36, 40)		14.0	9.0	9.0	
40			14.0	9.0		
42		(36, 40, 44, 48)	14.0	9.0		9.0
44			14.0	9.0		
46	(44, 48)		14.0	9.0	9.0	
48			14.0	9.0		
52			14.0	9.0		
54	(52, 56)		14.0	9.0	9.0	
56			14.0	9.0		
58		(52, 56, 60, 64)	14.0	9.0		9.0
60			14.0	9.0		
62	(60, 64)		14.0	9.0	9.0	
64			14.0	9.0		
100			20.0	16.0		
102	(100, 104)		20.0	16.0	16.0	
104			20.0	16.0		
106		(100, 104, 108, 112)	20.0	16.0		16.0
108			20.0	16.0		
110			20.0	16.0	16.0	
112			20.0	16.0		
114			20.0	16.0		
116			20.0	16.0		
118	(116, 120)		20.0	16.0	16.0	
120			20.0	16.0		
122		(116, 120, 124, 128)	20.0	16.0		16.0
124			20.0	16.0		
126	(124, 128)		20.0	16.0	16.0	
128			20.0	16.0		

<b>20 MHZ CHANNEL</b>	<b>40 MHZ CHANNEL</b>	<b>80 MHZ CHANNELS</b>	<b>LEGACY OFDM RATES (2TX)</b>	<b>802.11n HT20 RATES (2TX)</b>	<b>802.11n HT40 RATES (2TX)</b>	<b>802.11n HT80 RATES (2TX)</b>
130			20.0	16.0		
132			20.0	16.0		
134	(132, 136)		20.0	16.0	16.0	
136			20.0	16.0		
138			20.0	16.0		
140			20.0	16.0		
142			20.0	16.0		
144			20.0	16.0		

Polarized panel antenna, peak gain = 9.2dBi

## 25.7 NCC Domain

Refer to the following for an AP7562 antenna power table for the NCC domain.

### 25.7.1 2.4 GHz

2412 to 2462 MHz			
	ANTENNA GAIN (dBi)	TYPE	MAX CONDUCTED POWER SETTINGS (dBm)
ML-2499-FHPA5-01R	5.3	Dipole	20
ML-2499-HPA4-01	4.5	Dipole	20
ML-2452-HPA6-01	5.3	Dipole	20
ML-2452-HPAG4A6-01	4	Dipole	20
ML-2452-HPA6x6-036	4	Dipole	20
ML-2499-5PNL-72-N	6.5	Panel	20
ML-2452-PNL3M3-1	9.5	Dual-polarized panel	20
ML-2452-PNA5-01R	5.5	Panel	20

**25.7.2 5.2 GHz**

5250 to 5350 MHz			
	ANTENNA GAIN (dBi)	TYPE	MAX CONDUCTED POWER SETTINGS (dBm)
ML-5299-HPA5-01	5.6	Dipole	20
ML-2452-HPA6-01	6.1	Dipole	20
ML-2452-HPAG4A6-01	7.3	Dipole	20
ML-2452-HPA6x6-036	6	Dipole	20
ML-2452-PNL3M3-1	9.2	Dual-polarized panel	20
ML-2452-PNA5-01R	6	Panel	20

5470 to 5725 MHz			
	ANTENNA GAIN (dBi)	TYPE	MAX CONDUCTED POWER SETTINGS (dBm)
ML-5299-HPA5-01	5.6	Dipole	20
ML-2452-HPA6-01	6.1	Dipole	20
ML-2452-HPAG4A6-01	7.3	Dipole	20
ML-2452-HPA6x6-036	6	Dipole	20
ML-2452-PNL3M3-1	9.2	Dual-polarized panel	20
ML-2452-PNA5-01R	6	Panel	20

5725 to 5850 MHz			
	ANTENNA GAIN (dBi)	TYPE	MAX CONDUCTED POWER SETTINGS (dBm)
ML-5299-HPA5-01	5.6	Dipole	20
ML-2452-HPA6-01	6.1	Dipole	20
ML-2452-HPAG4A6-01	7.3	Dipole	20
ML-2452-HPA6x6-036	6	Dipole	20
ML-2452-PNL3M3-1	9.2	Dual-polarized panel	20
ML-2452-PNA5-01R	6	Panel	20







## ***Technical Support***

Comprehensive on-line support is available at the Support Central site at [www.zebra.com/support](http://www.zebra.com/support). Support Central provides our customers with a wealth of information and online assistance including developer tools, software downloads, product manuals and online repair requests.

When contacting the Support Center, please provide the following information:

- *serial number of unit*
- *model number or product name*
- *software type and version number.*

### ***Web Support Sites***

#### **Product Downloads**

[www.zebra.com/support](http://www.zebra.com/support)

#### **Manuals**

[www.zebra.com/support](http://www.zebra.com/support)





Zebra Technologies Corporation.  
Lincolnshire, IL 60069 USA

Zebra and the Zebra head graphic are registered trademarks of ZIH Corp. The Symbol logo is a registered trademark of Symbol Technologies, Inc., a Zebra Technologies company.

© 2015 Symbol Technologies, Inc.

MN002233A01 Revision A August 2015



[www.L-TronDirect.com](http://www.L-TronDirect.com)

800-830-9523

[info@L-Tron.com](mailto:info@L-Tron.com)

596 Fishers Station Dr | Victor, NY | 14564 | Suite 1 A

[www.L-Tron.com](http://www.L-Tron.com)

Get in touch with us  
on social media!

